

2022

Version 1



INSULATING CONCRETE FORMS
MANUFACTURERS ASSOCIATION
ICF-MA.ORG



INTEGRASPEC.COM

**The Insulating Concrete Forms Manufacturers Association
Prescriptive ICF Design for Part 9 Structures in Canada**

LEARN MORE ABOUT ICFS AT ICF-MA.ORG

This engineering is only authorized for use by ICFMA Members. ©2021 All Rights Reserved.

The Insulating Concrete Forms Manufacturers Association Prescriptive ICF Design for Part 9 Structures in Canada

Introduction

Preface

Welcome to the First Edition of the ICFMA Prescriptive ICF Design Tables for Part 9 Buildings in Canada. The following guideline specifications were developed on behalf of the member companies of the Insulating Concrete Form Manufacturers Association (ICFMA) by Tacoma Engineers Inc. with offices in Ontario, Canada.

Objective

The objective of this manual is to provide Prescriptive Tables, Engineering Details and ICF product information that is code compliant for buildings constructed under Part 9 of the 2015 National Building Code of Canada. This manual provides code compliant information for Insulating Concrete Forms across each provincial region of Canada and contains a broad scope of residential designs that cover specific nuances of individual provincial regions. Each of the tables and designs cover the standard specifications for products manufactured or produced by members of the ICFMA. This guide is available in both English and French language versions.

Scope

Design information contained in this guide applies to below-grade and above-grade ICF reinforced concrete walls, both load bearing and non-load bearing, that make up the exterior and/or interior of Part 9 buildings that fall within the limitations of this guide. Floor design/connections and roof design/connections are not covered in this guide and must be designed by others. Any other building component not specifically named in this guide must be designed by others or follow prescriptive provisions contained in the applicable building code. Fire resistance characteristics of ICF/concrete walls are not covered in this guide, but are available from your ICFMA member company upon request.

Applicability

The tables in this manual are the property of the ICFMA and are specific to products offered by ICFMA member companies. The tables are not authorized for use by non-member ICF manufacturers or non-ICF methods of concrete forming. If specific questions arise about how to design or reference the tables in this manual of an ICFMA members product check with the technical department of that ICFMA member company. For example: Coursing height may vary between 12 inches and 18 inches depending on brand used. Horizontal tie spacing may vary between 6 inches and 12 inches. Product specific nuances may affect how the tables in the guide are used.

Design information contained in this document is limited to use in buildings described in Section 1 “*Design Parameters*” of the guide, including a maximum number of below-grade and above-grade stories as well as certain building size limitations. While the intent of this guide are the broadest applicability of Canada and it’s individual provinces, there are some limits to applicability, including seismic response and wind loading. Building design may be limited by spans, deflection and aspect ratio among others.

CHECK ALL CONDITIONS THAT APPLY TO YOUR SITE AND BUILDING DESIGN TO ENSURE COMPATIBILITY WITH THE LIMITATIONS STATED IN SECTION 1 OF THIS GUIDE BEFORE PROCEEDING WITH ITS USE.

Engineered Design

These tables and specifications have been developed and reviewed against the 2015 National Building Code of Canada and CAN/ULC A23.3 by Tacoma Engineers. www.tacomaengineers.com Tables carry a stamp for all Canadian provinces. Check for a stamp applicable to your province before using or referring to the tables.

Review for code compliance will be carried out as building code and standards versions evolve. Check with your ICF member company for the most current guide version available.

Errata

All efforts have been made to create a publication free from errors. If ICFMA is notified of or discovers errors, errata will be published and posted on the ICFMA website at www.icf-ma.org.

Copyright

©2021 Insulating Concrete Form Manufacturers Association

All rights reserved. No part of this publication may be reproduced, stored in a retrieval system, or transmitted in any form or by any means, electronic, mechanical, photocopying, recording, or otherwise, without the prior permission of the copyright owner.

The Insulating Concrete Form Manufacturers Association (ICFMA) is a not-for-profit trade organization and provides this publication solely for the continuing education of qualified building design and construction professionals. This publication should only be used by qualified professionals who possess all required license(s) in the authority having jurisdiction and who are competent to evaluate the significance and limitations of the information provided herein. Any qualified professional who chooses to use any of the information found in this publication must accept total responsibility for the application of this information. Other readers should obtain assistance from a Qualified Professional before proceeding.

ICFMA and its members make no express or implied warranty with respect to this publication or any information contained herein. No warranty is made of merchantability or fitness for a particular purpose. ICFMA and its members disclaim any product liability (including without limitation any strict liability in tort) in connection with this publication or any information contained herein.

Acknowledgments

The Insulating Concrete Form Manufacturers Association wishes to express its thanks to the following individuals for their contributions and guidance throughout the process of creating this guide:

Ross Monsour – ICFMA Director

Robert Schulthorpe – Engineering Consultant

Nathan Proper – Tacoma Engineers

Morteza Mehrzadi – Tacoma Engineers

Jason Unruh – SuperForm ICF

Dennis Micoff – BuildBlock ICF

Francis Roma – Logix ICF

Keven Rector – Nudura ICF

Douglas Bennion – Quad-Lock ICF

Kelvin Doerr – Fox Blocks ICF

Brian Corder – BuildBlock ICF

Table of Contents

The Insulating Concrete Forms Manufacturers Association Prescriptive ICF Design for Part 9 Structures in Canada

Introduction	3		
Preface	3		
Objective.....	3		
Scope	3		
Applicability	3		
Engineered Design.....	3		
Errata.....	3		
Copyright	3		
Acknowledgments	3		
Structural Design - National and Provincial Codes and Stamps	5		
Design Limitation	9		
1. Design Parameters	9		
2. Construction	10		
3. Concrete	10		
4. Reinforcing Steel	10		
5. Above Grade and Below Grade Walls	10		
5.1 Distributed Reinforcing Steel	11		
5.2 Shear Walls	11		
5.3 Concentrated Point Loads on Walls.....	11		
5.4 Window and Door Openings.....	12		
5.4.1 Lintels.....	12		
5.5 Stair Openings.....	12		
5.6 Laterally Supported Unreinforced Foundation Wall	13		
5.7 Laterally Unsupported Foundation Walls (Knee Wall) with Wood Framing Above.....	13		
6. Wood Ledger Connection	13		
7. Brick Ledge	13		
8. Strip Footing	13		
Details & Tables Index	14		
Below & Above Grade Walls Details and Tables	17		
Detail B. 1. Below Grade Wall Reinforcing Placement for All Wall Thicknesses.....	17		
Detail A.1. Above Grade Wall Reinforcing Placement for 6", 8" and 10" Thick Walls.....	18		
Detail A.2. Above Grade Wall Reinforcing Placement for 12" Thick Walls.....	19		
Detail A.3. Alternating Horizontal Bar Spacing of 12" O.C. and 24" O.C. to Achieve an Average Spacing of 18" O.C. (Two Horizontal Bars in Every Three Rows of ICF Blocks).....	20		
Detail A.4. Three Horizontal Bars in Every Two Rows of 18" High Block to Achieve an Average Spacing of 12" O.C.....	20		
Detail A.5. Four Horizontal Bars in Every Three Rows of 16" High Block to Achieve an Average Spacing of 12" O.C.....	21		
Detail A.6. Alternating Vertical Bar Spacing of 8" O.C. and 16" O.C. to Achieve an Average Spacing of 12" O.C. (Two Vertical Bars in Every Three Cells).....	21		
Wall Configurations in a Building Without Walkout Basement	22		
Detail A.7.1. Main Floor Walls of One-Story Structure Supporting Wood Frame Roof.....	22		
Detail A.7.2. Second Floor Walls of a Two-Story ICF Structure Supporting Wood Frame Roof & Main Floor Walls of a Two-Story ICF Structure Supporting Wood Frame Floors and Roof.....	22		
Detail A.7.3. Main Floor Walls of a Two-Story Structure Supporting 2nd Story Wood Frame Walls, Floor and Roof.....	23		
Wall Configurations in a Building with Walkout Basement	24		
Detail A.8.1. Main Floor Walls of One-Story Structure Supporting Wood Frame Roof.....	24		
Detail A.8.2. Second Floor Walls of a Two-Story ICF Structure Supporting Wood Frame Roof & Main Floor Walls of a Two-Story ICF Structure Supporting Wood Frame Floors and Roof.....	25		
Detail A.8.3. Main Floor Walls of a Two-Story Structure Supporting 2nd Story Wood Frame Walls, Floor and Roof.....	26		
Walkout Basement Wall Configurations	27		
Detail A.9.1. Walkout Basement Wall of a Single Story ICF Structure Supporting Wood Frame Roof.	27		
Detail A.9.2. Walkout Basement Wall of a Two-Story ICF Structure Supporting Wood Frame Floors and Roof.	28		
Detail A.9.3. Walkout Basement Wall of a Two-Story Building with Main Floor ICF Walls Supporting Second Story Wood Framed Walls, Floor, and Roof.....	29		
Detail A.9.4. Walkout Basement Wall of a Two-Story Wood Framed Structure Supporting Wood Frame Floors, and Roof.Walls, Floor, and Roof.....	30		
Detail A.10. Shear Wall Concentrated Reinforcing Placement.....	31		
Detail A.11. Shear Wall Dowels.....	32		
Detail A.12. Above and Below Grade Wall Height.....	33		
Lintel Details and Tables	63		
Concentrated Point Load Table	90		
Stair Opening Tables	91		
Laterally Supported Foundation Wall Detail and Table	94		
Laterally Unsupported Foundation Wall Detail and Table (Knee Wall)	95		
Detail B.3. Laterally Unsupported Foundation Wall (Knee Wall) ..	95		
Detail B.4. Laterally Unsupported Foundation Wall (Knee Wall) with Brick Veneer	96		
Ledger Connection Detail and Table	97		
Brick Ledge Detail and Table	98		
Detail C. 2. Brick Ledge Connection	98		
Detail C.3. Fox Blocks xLerator Ledge Reinforcement	98		
Footing Details and Tables	100		
Detail F.1. Footing Dowel.....	100		
Table F.2- Minimum Exterior Strip Footing Sizes Not Supporting Roof Loads	101		
Table F.3- Minimum Exterior Strip Footing Sizes Supporting Roof Snow Loads $\leq 2\text{kPa}$	102		
Table F.4- Minimum Exterior Strip Footing Sizes Supporting Roof Snow Loads $\leq 4\text{kPa}$	103		
Appendix A: Equivalent Spectral Response Acceleration for ICF Walls, $S_{a,ICF}$	105		
Appendix B: Climatic Design Data	110		
Appendix C: Seismic Design Data for Selected Locations in Canada	129		

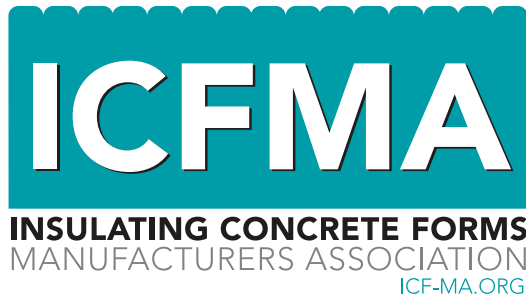

The Insulating Concrete Forms Manufacturers Association Prescriptive ICF Design for Part 9 Structures in Canada

Design Limitation

The design tables included in this manual were determined based on the parameters provided in this section. These tables cannot be used if the proposed construction does not meet all the parameters provided in this section or in the tables.

1. Design Parameters

- 1.1 These tables only apply to residential buildings conforming to Part 9 of the 2015 National Building Code of Canada (NBCC).
- 1.2 If the proposed construction does not meet the design or applicability of parameters noted herein, a local design professional shall be retained to prepare the design in accordance with applicable standards.
- 1.3 This design manual applies only to flat ICF walls (concrete core of uniform thickness). All walls must line up vertically.
- 1.4 In case this document conflicts with design codes, standards and building regulations, the code provisions shall apply.
- 1.5 The design and construction of all work shall conform to the latest editions of the NBCC, the local building code, local regulations and bylaws and the occupational health and safety act.
- 1.6 These tables have been designed to resist gravity, wind and earthquake forces in accordance with the 2015 NBCC for the criteria indicated in the design limitations and in the design tables.
- 1.7 Design is limited to one (1) floor below grade and a maximum of two (2) stories above grade.
- 1.8 The maximum building dimensions are:

Building Area	300 m ²	3200 ft ²
Maximum Building Dimension	24.4 m	80 ft
Building Aspect Ratio (Length:Width)		
$S_{a,ICF} \leq 0.2$	2.5:1	
$S_{a,ICF} > 0.2$	2:1	
Roof Clear Span	12.2 m	40 ft
Floor Clear Span	7.32 m	24 ft
Second Floor Wall Height	3.05 m	10 ft
Main Floor Wall Height	4.88 m	16 ft
Foundation Wall Height	3.66 m	12 ft

Note: $S_{a,ICF}$ is the equivalent spectral response acceleration for ICF walls, provided in Appendix A.

- 1.9 The maximum unfactored gravity loads are:

Roof Snow	4.0 kPa	84 psf
Floor Live	1.9 kPa	40 psf
Roof Dead	0.7 kPa	15 psf
Floor Dead	0.7 kPa	15 psf
Concrete Density	23.6 kN/m ³	150 lb/ft ³
Brick Veneer Density	20.0 kN/m ³	128 lb/ft ³
Floor Clear Span	7.32 m	24 ft
Second Floor Wall Height	3.05 m	10 ft
Main Floor Wall Height	4.88 m	16 ft
Foundation Wall Height	3.66 m	12 ft

- 1.10 The lateral soil pressures against below grade walls are:

Area Surcharge ($K_o = 0.5$)	2.4 kPa	50 psf
Equivalent Fluid Density of Soil ($K_o = 1.0$)	480 – 1200 kg/m ³	30 – 75 pcf

- 1.11 The wind loads are indicated in the design tables.
- 1.12 Seismic limits in wall analysis and design are based on $S_a(0.2)$ and $S_a(0.5)$ values. In order to simplify the tables, an equivalent seismic spectral response acceleration for ICF walls, $S_{a,ICF}$ is defined and provided in Appendix A. Equivalent spectral response, $S_{a,ICF}$ is used to calculate the seismic shear loads as given in following equation and the limits are indicated in shear wall tables.

$$V_{seismic} = F_a S_{a,ICF} / R_d R_o$$

where $F_a = \max(F_a(0.5))$ for soil type D or better = 1.47

- 1.13 The following peak ground acceleration (PGA) data was used in the analysis of below grade walls. These are the maximum associated values from Appendix C of the 2015 NBCC for the selected $S_a(0.2)$ values.

Sa(0.2)	0.25	0.7	1.20	1.75
PGA	0.16	0.434	0.724	1.04

- 1.14 Only seismic site classes A, B, C and D, as defined in Part 4 of the NBCC, are permitted.
- 1.15 Wall and lintel deflections have been limited to L/360.

- 1.16 The maximum building aspect ratio is the longest plan dimension divided by the shortest plan dimension of the building. Attached garages can be excluded from the aspect ratio calculation provided they are separated from the main building by ICF walls meeting the requirements of this guide.

2. Construction

- 2.1 Except as noted otherwise for specific conditions, the design assumes that ALL walls are laterally supported by the building foundation, roof and floor systems, designed by others. Roof and floor systems can be designed in accordance with part 9 of NBCC or building system manufacturers.
- 2.2 Foundation walls shall be laterally supported at the top and bottom prior to backfilling.
- 2.3 Provide lateral support at the bottom of the foundation wall in accordance with NBCC 2015 part 9.15.4.4. Alternatively, dowel the wall to the footing as per Table F. 1.
- 2.4 The contractor shall make adequate provision for construction loads and temporary bracing to keep the structure plumb and in true alignment at all phases of construction.
- 2.5 Hydrostatic pressure due to water build-up has not been included in the design and analysis. Backfill shall be drained in accordance with NBCC 2015 9.4.4.6.
- 2.6 Surface grading around the foundation is to slope away from building to allow surface water to drain away.
- 2.7 Provide adequate frost protection for all foundation walls and footings, both during construction and in the final installation.
- 2.8 Construction joints shall be made and located so as not to impair the strength of the structure. All specified reinforcing bars shall have minimum lap lengths across all construction joints.
- 2.9 Construction joints shall not be installed within 610 mm (2ft) of a wall opening.
- 2.10 All dimensions are in millimeters unless noted otherwise.
- 2.11 It is the responsibility of the roof and floor designer to ensure adequate bearing for all framing members is provided on the concrete walls.

3. Concrete

- 3.1 Concrete work shall conform to the latest editions of CSA A23.1,2,3 for materials and workmanship.
- 3.2 The minimum 28-day compressive strength of concrete shall be 20 MPa.
- 3.3 Maximum size of aggregates in concrete walls with minimum concrete cover of 40mm, are to be 19mm (3/4") diameter. Maximum aggregate size shall be limited to 12.5mm (1/2") if the concrete cover is less than 40mm.
- 3.4 Concrete pours shall be terminated at locations of lateral support.
- 3.5 Use high frequency vibration to place all concrete. Extra care is needed when vibrating during concrete placement for the purpose of ensuring a homogeneous aggregate distribution, without segregation.
- 3.6 Take adequate measures to protect concrete from exposure to freezing temperatures and precipitation at least seven days after concrete placement.

4. Reinforcing Steel

- 4.1 Use Grade 400 deformed rebar placed in accordance with the manual of standard practice.
- 4.2 Reinforcement size, spacing and placement to be in accordance with notes and design tables for above grade walls, below grade walls and lintels.
- 4.3 10M bars may be installed as distributed steel where 15M bars are specified provided they are installed at half the spacing required for 15M bars. 15M bars may be installed as distributed steel where 10M bars are specified, but must be installed at the same spacing as specified for the 10M bars.

- 4.4 The required number of bars specified for concentrated reinforcing steel can be converted to 15M bars as per the following conversion table:

Number of Concentrated Reinforcing Bars at the Ends of Shear Walls	
Specified 10M	Equivalent 15M
2	1
3 or 4	2
5 or 6	3

- 4.5 Maintain a minimum concrete clear cover and reinforcement spacing of 40mm (1 1/2") for all reinforcing steel, except 20mm (3/4") cover is permitted for below grade walls of heated buildings. The minimum concrete covers must be maintained for vertical bars in below grade walls.
- 4.6 Where bars within a lintel cannot achieve a minimum concrete side cover and spacing of 40mm (1 1/2"), the bars are required to be bundled. The following notes apply to all bundled bars:
- Groups of parallel reinforcing bars bundled in contact, assumed to act as a unit, with not more than four in any one bundle, may be used. Bundled bars shall be tied, wired, or otherwise fastened together to ensure that they remain in position.
 - Bundled bars shall not be spliced over the span of any lintel.
- 4.7 Minimum bar lap length shall be:
- 450 mm (18") for 10M bars
 - 650 mm (26") for 15M bars
 - 750 mm (30") for 20M bars
- 4.8 Standard hook lengths shall be:
- 200 mm (8") for 10M bars
 - 250 mm (10") for 15M bars
 - 300 mm (12") for 20M bars
- 4.9 Maximum transverse spacing (gap) between non-contact parallel bars spliced by lap splices, shall not exceed the lesser of one-fifth of the required lap splices length or 150mm.
- 4.10 Guidance was taken from PCA 100-2017 Prescriptive Design of Exterior Walls for One- and Two-Family Dwellings where steel reinforcement does not meet the minimum requirements of CSA A23.3 Clause 14.1. References to research conducted by PCA for these conditions are included in PCA 100-2017.
- 4.11 Where the vertical wall reinforcement spacing exceeds maximum spacing requirements according to CSA A23.3 Clause 14.1 the design capacity is at least one third more than required.
- 4.12 Horizontal temperature and shrinkage reinforcing steel may be less than specified in CSA A23.3. This is due to ideal curing conditions within the ICF system, which reduce the risk of cracking. In addition, finishes are not applied directly to the concrete wall; therefore, the risk of potential cracks propagating to the surface of the finishes is minimized.

5. Above Grade and Below Grade Walls

- 5.1 Wall thicknesses given in above and below grade wall tables are the nominal thicknesses. The actual thickness of the wall may vary by $\pm 1/4"$.
- 5.2 Above grade and below grade walls are designed to resist out-of-plane and in-plane loads by providing the specified reinforcing steel.

- 5.3 Provide horizontal and vertical distributed steel throughout all walls as described in the Distributed Reinforcing Steel section.
- 5.4 Provide additional concentrated horizontal and vertical steel around door and window openings, beside stair openings, under point loads, and at the ends of all walls and at all corners as described in the Window and Door Openings, Stair Openings, Concentrated Point Loads and Shear Walls sections.
- 5.5 The specified reinforcing is applicable to building with walkout basements. However, the global slope stability and building stability for unbalance soil pressures created by the walkout condition is by others.
- 5.6 Provide 600 mm (24") × 600 mm (24") horizontal bent dowel at each corner of the walls. Size and spacing of the dowel should match the horizontal reinforcement as per above and below grade tables.

5.1 Distributed Reinforcing Steel

- 5.1.1 Horizontal reinforcing is to consist of 10M or 15M continuous bars at 300 mm (12") o.c. to 900mm (36") o.c., in accordance with the tables.
- 5.1.2 Provide one continuous horizontal bar at maximum 150mm (6") from the top of the wall and at all floor levels.
- 5.1.3 Tables B. 1. 1, B. 2. 1, B. 3. 1 and B. 4. 1 provide the necessary distributed vertical steel to resist the out-of-plane loads for below grade ICF walls with 6" tie spacing.
- 5.1.4 Tables B. 1. 2, B. 2. 2, B. 3. 2 and B. 4. 2 provide the necessary distributed vertical steel to resist the out-of-plane loads for below grade ICF walls with 8" tie spacing.
- 5.1.5 Tables A. 1. 1 and A. 2. 1 provide the necessary distributed vertical steel to resist the out-of-plane loads for above grade ICF walls with 6" tie spacing.
- 5.1.6 Tables A. 2. 1 and A. 2. 2 provide the necessary distributed vertical steel to resist the out-of-plane loads for above grade ICF walls with 8" tie spacing.
- 5.1.7 Interpolation within the tables is not permitted.
- 5.1.8 Any table may be used where the local wind and seismic design values do not exceed the maximum values given in the table.
- 5.1.9 All basement walls in a building with a walkout condition shall be reinforced as a below grade wall for the maximum backfill height. Place the reinforcing in the center of the wall where the basement wall does not support any backfill.
- 5.1.10 The vertical distributed reinforcing bar spacing given in millimeters in the tables is the nominal dimension, the bar spacing in inches is the exact dimension. The vertical bar spacing is given as multiples of the form web spacing.
- 5.1.11 For walls below grade, the vertical reinforcing is to be placed on the inside face of the wall as shown in Detail B. 1.
- 5.1.12 For walls above grade, the vertical reinforcing is to be placed in the middle of the wall as shown in Detail A. 1.
- 5.1.13 Walls above grade formed using 300mm (12") forms shall have all distributed steel placed in two equal layers. One layer is to be placed in the exterior third of the wall and the other layer in the interior third of the wall as shown in Detail A. 2.
- 5.1.14 The height of an above grade wall is the distance from the top of the floor connection at its base to the bottom of the floor or roof connection at its top, as shown in Detail A. 12.
- 5.1.15 The height of a below grade wall is the distance from the top of the basement floor slab to the point of bearing for the floor system, as shown in Detail A. 12.
- 5.1.16 Backfill height against a below grade wall is the distance from the top of the basement floor slab to the finished exterior grade level.
- 5.1.17 Alternating horizontal bar spacing of 12" o.c. and 24" o.c. may be used to achieve an average spacing of 18" o.c. where

18" o.c. spacing is specified for horizontal bars as shown in Detail A. 3.

- 5.1.18 Provide three horizontal bars in every two rows of 18" high block to achieve an average spacing of 12" o.c. where 12" spacing o.c. is specified for horizontal bars as shown in Detail A. 4.
- 5.1.19 Provide four horizontal bars in every three rows of 16" high block to achieve an average spacing of 12" o.c. where 12" spacing o.c. is specified for horizontal bars as shown in Detail A. 5.
- 5.1.20 Alternating vertical bar spacing of 8" o.c. and 16" o.c. may be used to achieve an average spacing of 12" o.c. where 12" o.c. spacing is specified for vertical bars as shown in Detail A. 6.
- 5.1.21 Distributed reinforcing in a wall shall not be less than that required for the wall above.

5.2 Shear Walls

- 5.2.1 Shear walls are solid ICF wall segments between openings and corners.
- 5.2.2 Openings 150mm (6") in diameter and less are permitted within a shear wall, provided they do not occur within 300mm (12") of the ends of the shear wall.
- 5.2.3 Shear walls are designed for building with or without walkout basement. Wall configurations for building without and with walkout basement are shown in Detail A. 7 and Detail A. 8, respectively. Wall configurations for walkout basement walls is shown in Detail A. 9.
- 5.2.4 A minimum number and length of shear walls is required in all four sides of the building on all levels in the building as specified in shear wall tables (A.3. to A.11.) for above grade walls. This is to replace the requirements for 1200mm long wall segments at each corner in exterior walls specified in NBCC 9.20.173.(1) and 9.20.174.(1).
- 5.2.5 Below grade walls shall have the same number and length of shear walls as required for the walls immediately above.
- 5.2.6 All walls shall be proportionally and evenly distributed in both the transverse and longitudinal direction of the building.
- 5.2.7 A minimum number of full height vertical reinforcing bars are to be installed at the ends of all required shear walls in accordance with shear wall tables (A.3. to A.11.) for the number and length of shear walls provided. These bars are referred to as concentrated reinforcement and are in addition to the distributed reinforcement specified elsewhere.
- 5.2.8 The concentrated vertical reinforcement at the ends of each required shear wall is to be placed in accordance with Detail A. 10.
- 5.2.9 Matching dowels are to be provided for the concentrated and distributed vertical reinforcement at the base of all required shear walls into floor below as shown in Detail A. 11.
- 5.2.10 Horizontal reinforcement in shear walls where $S_{a,ICF} > 0.2$ shall be terminated at the ends of the wall with a standard hook.
- 5.2.11 Choose the first column in shear wall tables (A.3. to A.11.) that meets the minimum required number and lengths of shear wall to determine the minimum number of bars to install at the ends of all shear walls (sides of all openings and at each corner). Therefore, first check if there is at least one shear wall that meets the minimum length requirement given in the table for one shear wall. If not, then check if there are at least two shear walls that meet the minimum length requirement given in the table for two shear walls, and so on. When a number of shear walls is found that meets the minimum length requirements, use that column to determine the required concentrated reinforcement at the ends of those shear walls.

5.3 Concentrated Point Loads on Walls

- 5.3.1 All point loads, such as concentrated loads created by girder trusses, columns and beams, shall bear directly on top of the concrete wall, and shall not be hung or in any other manner

create an eccentric loading on the concrete wall. Provide beam pockets, as necessary.

- 5.3.2 The minimum length of solid wall without openings directly below point loads, such as concentrated loads created by girder trusses, columns and beams, shall be 6'-0". In addition to the wall reinforcing required in the following tables, two additional 15M vertical bars shall be installed directly below the point load. This length of solid wall may contain a corner.
- 5.3.3 Use Table C. 1 for the maximum unfactored point load that can be applied on a solid wall without opening if length of the wall is less than 6'-0".
- 5.3.4 Maximum unfactored point loads given in Table C. 1 are only the wall capacity. It is the responsibility of the roof and floor designer to ensure adequate bearing for all framing members is provided on the concrete walls.

5.4 Window and Door Openings

- 5.4.1 The cumulative width of openings in above grade walls shall not be more than 70% of the total wall length.
- 5.4.2 The cumulative width of openings in below grade walls shall not be more than 25% of the total wall length.
- 5.4.3 Openings in below grade walls shall not exceed a maximum width of 1.83m (6'-0") and a maximum height of 0.914m (3'-0").
- 5.4.4 The length of solid wall between two openings in below grade walls shall be equal to the average width of the openings and at least 1.22m (4'-0").
- 5.4.5 A minimum of 2-10M bars is to be installed completely around all sides of openings.
- 5.4.6 Provide additional horizontal reinforcing steel directly above the opening as required for lintels.
- 5.4.7 Horizontal bars above and below the opening shall extend a minimum of 610mm (24") past opening.
- 5.4.8 Vertical bars on each side of the opening shall extend the full height of the wall.
- 5.4.9 Distributed vertical reinforcing steel that is interrupted by an opening shall be replaced by an equal amount of concentrated vertical reinforcing steel with half placed on each side of the opening. The additional steel is to be evenly distributed within a distance equal to half the opening width, up to a maximum of 1.22m (4'-0"), from each side of the opening.
- 5.4.10 If the spacing of the additional concentrated vertical reinforcing required on each side of openings, described in the previous note, is less than 150mm (6"), a local design professional shall be retained to prepare the design in accordance with applicable standards.
- 5.4.11 Provide additional vertical reinforcing at the sides of openings as required at the ends of shear walls.

5.4.1 Lintels

- 5.4.1.1 All concrete wall segments above openings are to be considered lintels.
- 5.4.1.2 The top of all lintels is to be laterally supported by the roof and floor systems, designed by others.
- 5.4.1.3 Lintels shall be a minimum of 200mm (8") deep.
- 5.4.1.4 Lintel bottom reinforcing is to be installed a maximum of 89mm (3½") from the bottom of the lintel and is to extend a minimum of 610mm (24") past the wall opening.
- 5.4.1.5 A minimum of 2-10M bars is to be installed completely around all sides of openings, as shown in Detail L. 1.
- 5.4.1.6 Where stirrups are required for lintels with uniformly distributed load, they shall be single 10M hook stirrups installed around bottom and top bars over the given end distance at each side of the beam as shown in Detail L. 2.
- 5.4.1.7 Where stirrups are required for lintels with concentrated load, they shall be single 10M hook stirrups installed around

bottom and top bars over the whole length of the beam.
5.4.1.4.

- 5.4.1.8 Minimum lintel reinforcing is to consist of bottom bars indicated in the design tables, along with horizontal 10M continuous wall reinforcing at 406mm (16") on center, and a minimum of 1-10M top bar located 50mm (2") from the top of the lintel, as shown in Detail L. 3.
- 5.4.1.9 Provide a minimum of three stirrups in all lintels at the spacing indicated in the tables when $S_a(0.2) > 0.4$.
- 5.4.1.10 The lintel design tables are only applicable for uniformly distributed gravity line loads and point loads, such as concentrated loads created by girder trusses, columns and beams.
- 5.4.1.11 Concentrated load lintel tables consider only a single concentrated load acting on anywhere along the lintel span.
- 5.4.1.12 The lintel tables do not consider uniform and concentrated load to act simultaneously on the lintel.
- 5.4.1.13 The uniformly distributed load (UDL) is calculated by multiplying the roof and/or floor loads, including snow load (SL), live load (LL) and dead load (DL), by the tributary width (TW) of the roof and/or floor. The tributary width is determined by adding half the span of each rafter/joist bearing on the concrete lintel. For example, the UDL for a lintel supporting floor joists spanning 10'-0" and roof trusses spanning 30'-0" on one side only is calculated as follows:
- $$UDL = TW_{FLOOR} * (LL_{FLOOR} + DL_{FLOOR}) + TW_{ROOF} * (SL_{ROOF} + DL_{TROOF})$$
- $$UDL = (10 \text{ ft}/2) * (40 \text{ psf} + 15 \text{ psf}) + (30 \text{ ft}/2) * (84 \text{ psf} + 15 \text{ psf})$$
- $$UDL = 275 \text{ lbs}/\text{ft} + 1485 \text{ lbs}/\text{ft} = 1760 \text{ lbs}/\text{ft}$$
- 5.4.1.14 The weight of walls above the lintel has been included in the design of the lintel tables and does not need to be added to the UDL calculated as described above.
- 5.4.1.15 Where there is less than 305mm (12") of wall between openings, the lintel shall be reinforced to span over both openings, as shown in Detail L. 4.
- 5.4.1.16 Where there is less than 610mm (24") of wall between openings, and openings are greater than 1.53m (5'-0") in length, the lintel shall be reinforced to span over both openings, as shown in Detail L. 5.

5.5 Stair Openings

- 5.5.1 Additional reinforcement is to be provided in exterior walls where a stair opening interrupts the required lateral support provided by the floor framing.
- 5.5.2 Table A. 12. provides the maximum dimension of stair opening parallel to the wall and the required horizontal reinforcement of above grade walls at stair opening.
- 5.5.3 Table B. 5. provides the maximum dimension of stair opening parallel to the wall and the required horizontal reinforcement of below grade walls at stair opening. Below grade walls at stair openings are designed for a backfill equivalent fluid density of 480 kg/m³ and a maximum $S_a(0.2)$ of 0.7. Reinforcement design of below grade walls at stair openings shall be reviewed by a professional engineer if the wall does not meet the requirement of this table.
- 5.5.4 Lateral restraint of the wall is to be provided by the floor framing on each side of the stair opening, by others.

- 5.5.5 The spacing of distributed vertical reinforcement is to be reduced for a distance of 1.22m (4'-0") on each side of the stair opening for above grade and below grade walls. The required spacing is calculated by the following equation and listed in Table A. 13.

$$\text{(METRIC)} \quad S_{\text{REDUCED}} = 2.44 / (L_{\text{UNSUPPORTED}} + 2.44) * S_{\text{TABLES}}$$

$$\text{(IMPERIAL)} \quad S_{\text{REDUCED}} = 8 / (L_{\text{UNSUPPORTED}} + 8) * S_{\text{TABLES}}$$

where

S_{REDUCED} = the bar spacing (mm/in) required at the sides of the stair opening.

S_{TABLES} = the required bar spacing (mm/in) for a laterally supported wall as determined from above grade and below grade walls tables.

$L_{\text{UNSUPPORTED}}$ = the length of wall (m/ft) that is laterally unsupported as a result of a stair opening in the floor framing.

- 5.5.6 If the stair opening is out of the scope of design limitations for stair opening table, additional distributed horizontal reinforcing bars are to be added at the stair opening as specified by a professional engineer.

5.6 Laterally Supported Unreinforced Foundation Wall

- 5.6.1 Foundation walls in this section are designed for backfill equivalent fluid density of 480 kg/m³ in accordance with section 9.4.4.6 of NBC 2015 & OBC 2012r2020.
- 5.6.2 If the foundation wall is laterally supported at the top (e.g. by floor joists) and meets all the requirements of NBC 2015 section 9.15.4, and supports only wood frame construction above, a 20 MPa unreinforced concrete wall is adequate for the specific wall and backfill height, as per NBC 2015 table 9.15.4.2.A, shown in Detail B. 2.
- 5.6.3 Use below grade wall tables if the height of the wall and / or backfilled soil is greater than the maximum values of Table B. 6.
- 5.6.4 Use below grade wall tables for walls supporting ICF wall above.

5.7 Laterally Unsupported Foundation Walls (Knee Wall) with Wood Framing Above

- 5.7.1 If the foundation wall is not supported at the top (e.g. by floor joists) and supports only wood frame construction above, the design can follow the knee wall design as shown in Details B.3 and B.4. The design includes both the footing sizing and reinforcing of the footing and wall.
- 5.7.2 If heights of backfilled soil and / or foundation wall are greater than what shown in these details, reinforcement design of the wall must be reviewed by a professional engineer.
- 5.7.3 Foundations are to bear directly on material suitable for 75 kPa (1566 psf) bearing pressure.

6. Wood Ledger Connection

- 6.1 Anchor bolts are designed to transfer vertical load of floor to the ICF wall. Design of floor diaphragm by others.
- 6.2 Design loads are 40psf (1.9 kPa) floor live load, 15psf (0.7 kPa) floor dead load.
- 6.3 Anchor bolts are to be staggered as shown in Detail C. 1. Use Table C. 2. for size and spacing of the anchors.

7. Brick Ledge

- 7.1 The concrete ledge is to support uniformly distributed loads only. It is not to support concentrated load. A brick ledge section is shown in Detail C. 2.
- 7.2 Table C. 3. provides the brick ledge capacity as the total height of brick veneer or tributary width of a floor that can be supported per unit length of the brick ledge.
- 7.3 The capacity given in Table C. 3. is only for the capacity of the brick ledge. The veneer height may be limited by other

building code requirement or manufacturer's installation requirements.

- 7.4 The above grade and below grade wall reinforcing tables include the effects of using the ledge to support floor framing.
- 7.5 The below grade wall reinforcing tables include the effects of using the ledge to support masonry veneer.
- 7.6 The maximum brick height given does not account for windows. To include the effect of windows, it is necessary to calculate an effective brick height.
- 7.7 The ledge reinforcement is 10M hooked rebar, as shown in Detail C. 2 or Fox Blocks xLerator as shown in Detail C. 3. It is to be placed 6" or 8" on center matching the tie spacing of ICF blocks.

8. Strip Footing

- 8.1 Tables F. 2. to F. 4. provides minimum width and thickness of footing for different loadings and soil bearing pressures.
- 8.2 Soft areas uncovered during excavation shall be sub-excavated to sound material and filled with clean and free drained granular soil.
- 8.3 Protect soil from freezing adjacent to and below all footings.
- 8.4 All footings are to be reinforced with 2-15M continuous bars, as per Detail F. 1.
- 8.5 Tables F. 2. to F. 4. do not include masonry veneer. Increase the footing width by 2" and the thickness by 1" for:
- Every 12'-0" of masonry veneer for 3000psf soil bearing capacity.
 - Every 10'-0" of masonry veneer for 2500psf soil bearing capacity.
 - Every 8'-0" of masonry veneer for 2000psf soil bearing capacity.
 - Every 6'-0" of masonry veneer for 1500psf soil bearing capacity.
- 8.6 The footing size for locations with $S_a(0.2) > 0.4$ to be the larger of 30" wide by 12" deep or the size shown in the table.
- 8.7 Provide footing dowels as shown in Detail F. 1.
- 8.8 Footing dowels are 10M or 15M bars embedded 6" or 8" into the footing. Dowels size and spacing is given in Table F. 1.
- 8.9 Provide bent dowels as per Note. 4 of Table F. 1, at shear walls locations matching the size and spacing of vertical bars of the shear walls.

Details & Tables Index

18	Detail A.1. Above Grade Wall Reinforcing Placement for 6", 8" and 10" Thick Walls.	50	Table A.1.1. Above Grade Wall Distributed Reinforcement for Seismic Zone Classification, $S_{a,ICF} \leq 0.2$ and Hourly Wind Pressure, $q_{1/50} \leq 1.05$ for ICF Walls with 6" Tie Spacing
19	Detail A.2. Above Grade Wall Reinforcing Placement for 12" Thick Walls.	51	Table A.1.2. Above Grade Wall Distributed Reinforcement for Seismic Zone Classification, $S_{a,ICF} \leq 0.2$ and Hourly Wind Pressure, $q_{1/50} \leq 1.05$ for Walls with 8" Tie Spacing
20	Detail A.3. Alternating Horizontal Bar Spacing of 12" O.C. and 24" O.C. to Achieve an Average Spacing of 18" O.C. (Two Horizontal Bars in Every Three Rows of ICF Blocks)	52	Table A.2.1. Above Grade Wall Distributed Reinforcement for Seismic Zone Classification, $S_{a,ICF} \geq 0.2$ and Hourly Wind Pressure, $q_{1/50} \leq 1.05$ for ICF Walls with 6" Tie Spacing
20	Detail A.4. Three Horizontal Bars in Every Two Rows of 18" High Block to Achieve an Average Spacing of 12" O.C.	53	Table A.2.2. Above Grade Wall Distributed Reinforcement for Seismic Zone Classification, $S_{a,ICF} \geq 0.2$ and Hourly Wind Pressure, $q_{1/50} \leq 1.05$ for ICF Walls with 8" Tie Spacing
21	Detail A.5. Four Horizontal Bars in Every Three Rows of 16" High Block to Achieve an Average Spacing of 12" O.C.	54	Table A.3. Above Grade Shear Wall Concentrated Vertical Reinforcement for Seismic Zone Classification, $S_{a,ICF} \leq 0.2$ and Hourly Wind Pressure, $q_{1/50} \leq 0.5kPa$ (in a Building Without Walkout Basement)
21	Detail A.6. Alternating Vertical Bar Spacing of 8" O.C. and 16" O.C. to Achieve an Average Spacing of 12" O.C. (Two Vertical Bars in Every Three Cells)	55	Table A.4 – Above Grade Shear Wall Concentrated Vertical Reinforcement for Seismic Zone Classification, $S_{a,ICF} \leq 0.2$ and Hourly Wind Pressure, $0.5kPa < q_{1/50} \leq 0.75kPa$ (in a Building Without Walkout Basement)
22	Detail A.7.1. Main Floor Walls of One-Story Structure Supporting Wood Frame Roof.	56	Table A.5 – Above Grade Shear Wall Concentrated Vertical Reinforcement for Seismic Zone Classification, $S_{a,ICF} \leq 0.2$ and Hourly Wind Pressure, $0.75kPa < q_{1/50} \leq 1.05kPa$ (in a Building Without Walkout Basement)
22	Detail A.7.2. Second Floor Walls of a Two-Story ICF Structure Supporting Wood Frame Roof & Main Floor Walls of a Two-Story ICF Structure Supporting Wood Frame Floors and Roof.	57	Table A.6 – Above Grade Shear Wall Concentrated Vertical Reinforcement for Seismic Zone Classification, $S_{a,ICF} > 0.2$ and Hourly Wind Pressure, $q_{1/50} \leq 1.05kPa$ (in a Building Without Walkout Basement)
23	Detail A.7.3. Main Floor Walls of a Two-Story Structure Supporting 2nd Story Wood Frame Walls, Floor and Roof.	58	Table A.7. Above Grade Shear Wall Concentrated Vertical Reinforcement for Seismic Zone Classification, $S_{a,ICF} \leq 0.2$ and Hourly Wind Pressure, $q_{1/50} \leq 0.5kPa$ (in a Building With Walkout Basement)
24	Detail A.8.1. Main Floor Walls of One-Story Structure Supporting Wood Frame Roof.	59	Table A.8 – Above Grade Shear Wall Concentrated Vertical Reinforcement for Seismic Zone Classification, $S_{a,ICF} \leq 0.2$ and Hourly Wind Pressure, $0.5kPa < q_{1/50} \leq 0.75kPa$ (in a Building With Walkout Basement)
25	Detail A.8.2. Second Floor Walls of a Two-Story ICF Structure Supporting Wood Frame Roof & Main Floor Walls of a Two-Story ICF Structure Supporting Wood Frame Floors and Roof.	60	Table A.9 – Above Grade Shear Wall Concentrated Vertical Reinforcement for Seismic Zone Classification, $S_{a,ICF} \leq 0.2$ and Hourly Wind Pressure, $0.75kPa < q_{1/50} \leq 1.05kPa$ (in a Building With Walkout Basement)
26	Detail A.8.3. Main Floor Walls of a Two-Story Structure Supporting 2nd Story Wood Frame Walls, Floor and Roof.	61	Table A.10 – Above Grade Shear Wall Concentrated Vertical Reinforcement for Seismic Zone Classification, $S_{a,ICF} > 0.2$ and Hourly Wind Pressure, $q_{1/50} \leq 1.05kPa$ (in a Building With Walkout Basement)
27	Detail A.9.1. Walkout Basement Wall of a Single Story ICF Structure Supporting Wood Frame Roof.	62	Table A.11 – Above Grade Walkout Basement Shear Wall Concentrated Vertical Reinforcement for Seismic Zone Classification, $S_{a,ICF} \leq 0.4$ and Hourly Wind Pressure, $q_{1/50} \leq 1.05kPa$
28	Detail A.9.2. Walkout Basement Wall of a Two-Story ICF Structure Supporting Wood Frame Floors and Roof.	91	Table A.12. Above Grade Wall Distributed Horizontal Reinforcement at Stair Openings
29	Detail A.9.3. Walkout Basement Wall of a Two-Story Building with Main Floor ICF Walls Supporting Second Story Wood Framed Walls, Floor, and Roof.	93	Table A.13. Bar Spacing Required at Each Side of the Stair Opening
30	Detail A.9.4. Walkout Basement Wall of a Two-Story Wood Framed Structure Supporting Wood Frame Floors, and Roof. Walls, Floor, and Roof.	34	Table B.1.1.– Below Grade Wall Distributed Reinforcement for Seismic Zone Classification, $S_a(0.2) \leq 0.25$ and Hourly Wind Pressure, $q_{1/50} \leq 1.05kPa$, for ICF Walls with 6" Tie Spacing
31	Detail A.10. Shear Wall Concentrated Reinforcing Placement.	35	Table B.1.1. Continued – Below Grade Wall Distributed Reinforcement for Seismic Zone Classification, $S_a(0.2) \leq 0.25$ and Hourly Wind Pressure, $q_{1/50} \leq 1.05kPa$, for ICF Walls with 6" Tie Spacing
32	Detail A.11. Shear Wall Dowels.	36	Table B.1.2.– Below Grade Wall Distributed Reinforcement for Seismic Zone Classification, $S_a(0.2) \leq 0.25$ and Hourly Wind Pressure, $q_{1/50} \leq 1.05kPa$, for ICF Walls with 8" Tie Spacing
33	Detail A.12. Above and Below Grade Wall Height	37	Table B.1.2. Continued – Below Grade Wall Distributed Reinforcement for Seismic Zone Classification, $S_a(0.2) \leq 0.25$ and Hourly Wind Pressure, $q_{1/50} \leq 1.05kPa$, for ICF Walls with 8" Tie Spacing
17	Detail B. 1. Below Grade Wall Reinforcing Placement for All Wall Thicknesses.		
94	Detail B.2. Laterally Supported Foundation Wall		
95	Detail B.3. Laterally Unsupported Foundation Wall (Knee Wall)		
96	Detail B.4. Laterally Unsupported Foundation Wall (Knee Wall) with Brick Veneer		
97	Detail C.1. Wood Ledger Connection		
98	Detail C. 2. Brick Ledge Connection		
98	Detail C.3. Fox Blocks xLerator Ledge Reinforcement		
100	Detail F.1. Footing Dowel		
63	Detail L. 1. Reinforcing Around Openings.		
64	Detail L. 2. Lintel Stirrup Detail.		
64	Detail L. 3. Lintel Section		
65	Detail L. 4. Lintel Span with Less Than 305mm (12") of Wall Between Openings.		
65	Detail L. 5. Lintel Span with Less Than 610mm (24") of Wall Between Openings, and Openings Are Greater Than 1.53m (5'-0") in Length.		

38	Table B.2.1. – Below Grade Wall Distributed Reinforcement for Seismic Zone Classification, $0.25 < Sa(0.2) \leq 0.70$ and Hourly Wind Pressure, $q_{1/50} \leq 1.05kPa$, for ICF Walls with 6" Tie Spacing	143	Table C-3 (Continued)
39	Table B.2.1. Continued – Below Grade Wall Distributed Reinforcement for Seismic Zone Classification, $0.25 < Sa(0.2) \leq 0.70$ and Hourly Wind Pressure, $q_{1/50} \leq 1.05kPa$, for ICF Walls with 6" Tie Spacing	144	Table C-3 (Continued)
40	Table B.2.2. – Below Grade Wall Distributed Reinforcement for Seismic Zone Classification, $0.25 < Sa(0.2) \leq 0.70$ and Hourly Wind Pressure, $q_{1/50} \leq 1.05kPa$, for ICF Walls with 8" Tie Spacing	145	Table C-3 (Continued)
41	Table B.2.2. Continued – Below Grade Wall Distributed Reinforcement for Seismic Zone Classification, $0.25 < Sa(0.2) \leq 0.70$ and Hourly Wind Pressure, $q_{1/50} \leq 1.05kPa$, for ICF Walls with 8" Tie Spacing	146	Table C-3 (Continued)
42	Table B.3.1. – Below Grade Wall Distributed Reinforcement for Seismic Zone Classification, $0.70 < Sa(0.2) \leq 1.2$ and Hourly Wind Pressure, $q_{1/50} \leq 1.05kPa$, for ICF Walls with 6" Tie Spacing	100	Table F.1- Footing Dowels Size and Spacing
43	Table B.3.1. Continued – Below Grade Wall Distributed Reinforcement for Seismic Zone Classification, $0.70 < Sa(0.2) \leq 1.2$ and Hourly Wind Pressure, $q_{1/50} \leq 1.05kPa$, for ICF Walls with 6" Tie Spacing	101	Table F.2- Minimum Exterior Strip Footing Sizes Not Supporting Roof Loads
44	Table B.3.2. – Below Grade Wall Distributed Reinforcement for Seismic Zone Classification, $0.70 < Sa(0.2) \leq 1.2$ and Hourly Wind Pressure, $q_{1/50} \leq 1.05kPa$, for ICF Walls with 8" Tie Spacing	102	Table F.3- Minimum Exterior Strip Footing Sizes Supporting Roof Snow Loads $\leq 2kPa$
45	Table B.3.2. Continued– Below Grade Wall Distributed Reinforcement for Seismic Zone Classification, $0.70 < Sa(0.2) \leq 1.2$ and Hourly Wind Pressure, $q_{1/50} \leq 1.05kPa$, for ICF Walls with 8" Tie Spacing	103	Table F.4- Minimum Exterior Strip Footing Sizes Supporting Roof Snow Loads $\leq 4kPa$
46	Table B.4.1. – Below Grade Wall Distributed Reinforcement for Seismic Zone Classification, $1.2 < Sa(0.2) \leq 1.75$ and Hourly Wind Pressure, $q_{1/50} \leq 1.05kPa$, for ICF Walls with 6" Tie Spacing	66	Table L1 6" Lintel Reinforcement with Uniformly Distributed Load
47	Table B.4.1. Continued– Below Grade Wall Distributed Reinforcement for Seismic Zone Classification, $1.2 < Sa(0.2) \leq 1.75$ and Hourly Wind Pressure, $q_{1/50} \leq 1.05kPa$, for ICF Walls with 6" Tie Spacing	67	Table L1 Continued
48	Table B.4.2. – Below Grade Wall Distributed Reinforcement for Seismic Zone Classification, $1.2 < Sa(0.2) \leq 1.75$ and Hourly Wind Pressure, $q_{1/50} \leq 1.05kPa$, for ICF Walls with 8" Tie Spacing	68	Table L1 Continued
49	Table B.4.2. Continued– Below Grade Wall Distributed Reinforcement for Seismic Zone Classification, $1.2 < Sa(0.2) \leq 1.75$ and Hourly Wind Pressure, $q_{1/50} \leq 1.05kPa$, for ICF Walls with 8" Tie Spacing	69	Table L2 8" Lintel Reinforcement with Uniformly Distributed Load
92	Table B. 5. Below Grade Wall Distributed Horizontal Reinforcement at Stair Opening for Seismic Zone Classification $Sa(0.2) \leq 0.7$, Hourly Wind Pressure , $q_{1/50} \leq 1.05 kPa$, and Backfill	70	Table L2 Continued
94	Table B.6. Maximum Height of Finish Ground Above Basement Floor	71	Table L2 Continued
90	Table C.1. Maximum Unfactored Point Load on a Solid Wall Without Opening	72	Table L3 10" Lintel Reinforcement with Uniformly Distributed Load
97	Table C.2. Floor Ledger Anchor Bolts Size and Spacing	73	Table L3 Continued
99	Table C.3 Brick Ledge Load Capacity	74	Table L3 Continued
130	Table C-3 (Continued)	75	Table L4 12" Lintel Reinforcement with Uniformly Distributed Load
131	Table C-3 (Continued)	76	Table L4 Continued
132	Table C-3 (Continued)	77	Table L4 Continued
133	Table C-3 (Continued)	78	Table L5 6" Lintel Reinforcement Concentrated Load
134	Table C-3 (Continued)	79	Table L5 Continued
135	Table C-3 (Continued)	80	Table L5 Continued
136	Table C-3 (Continued)	81	Table L6 8" Lintel Reinforcement Concentrated Load
137	Table C-3 (Continued)	82	Table L6 Continued
138	Table C-3 (Continued)	83	Table L6 Continued
139	Table C-3 (Continued)	84	Table L7 10" Lintel Reinforcement Concentrated Load
140	Table C-3 (Continued)	85	Table L7 Continued
141	Table C-3 (Continued)	86	Table L7 Continued
142	Table C-3 (Continued)	87	Table L8 12" Lintel Reinforcement Concentrated Load
		88	Table L8 Continued
		89	Table L8 Continued

Below & Above Grade Walls Details and Tables

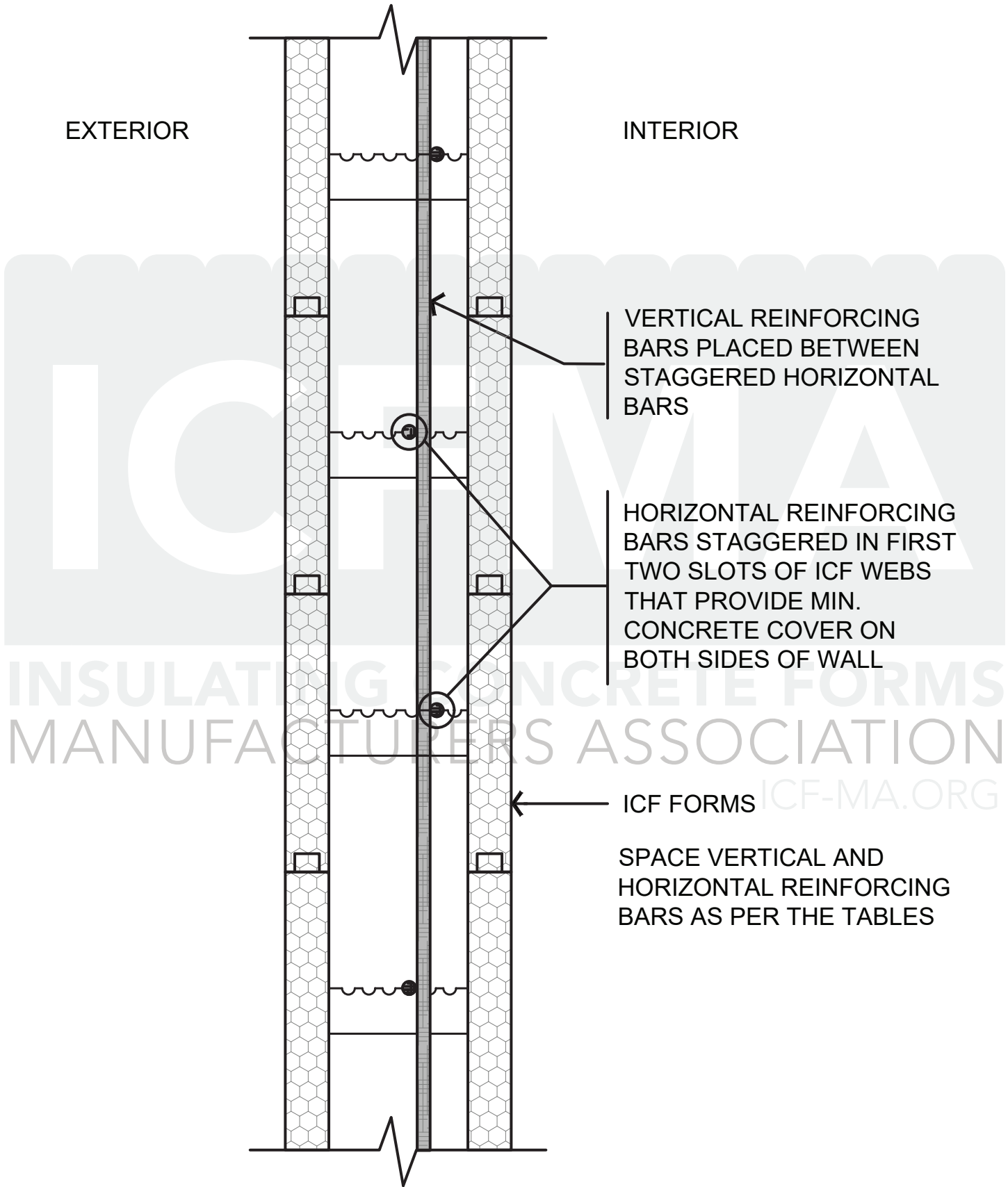

Detail B. 1. Below Grade Wall Reinforcing Placement for All Wall Thicknesses.

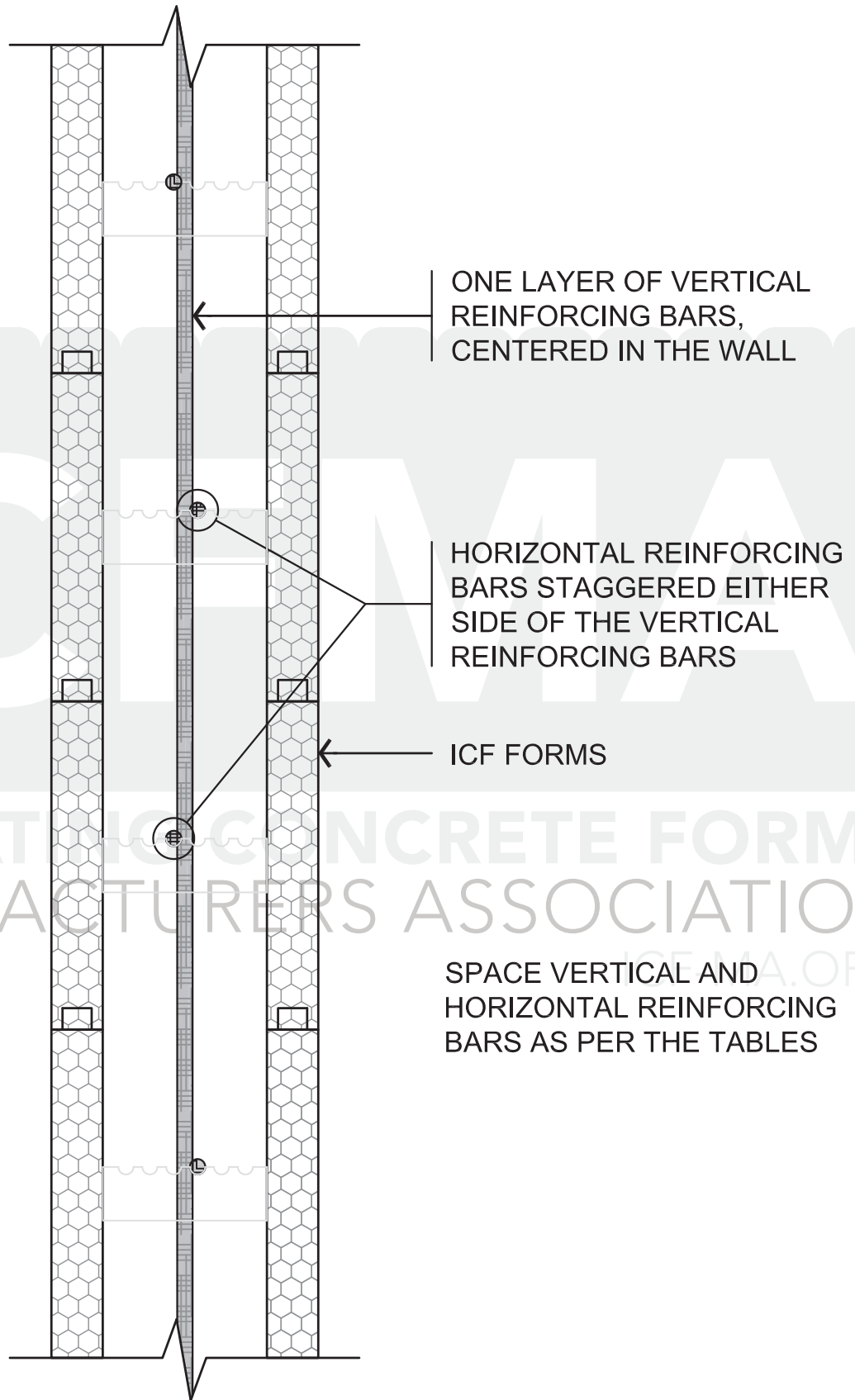

Detail A.1. Above Grade Wall Reinforcing Placement for 6", 8" and 10" Thick Walls.

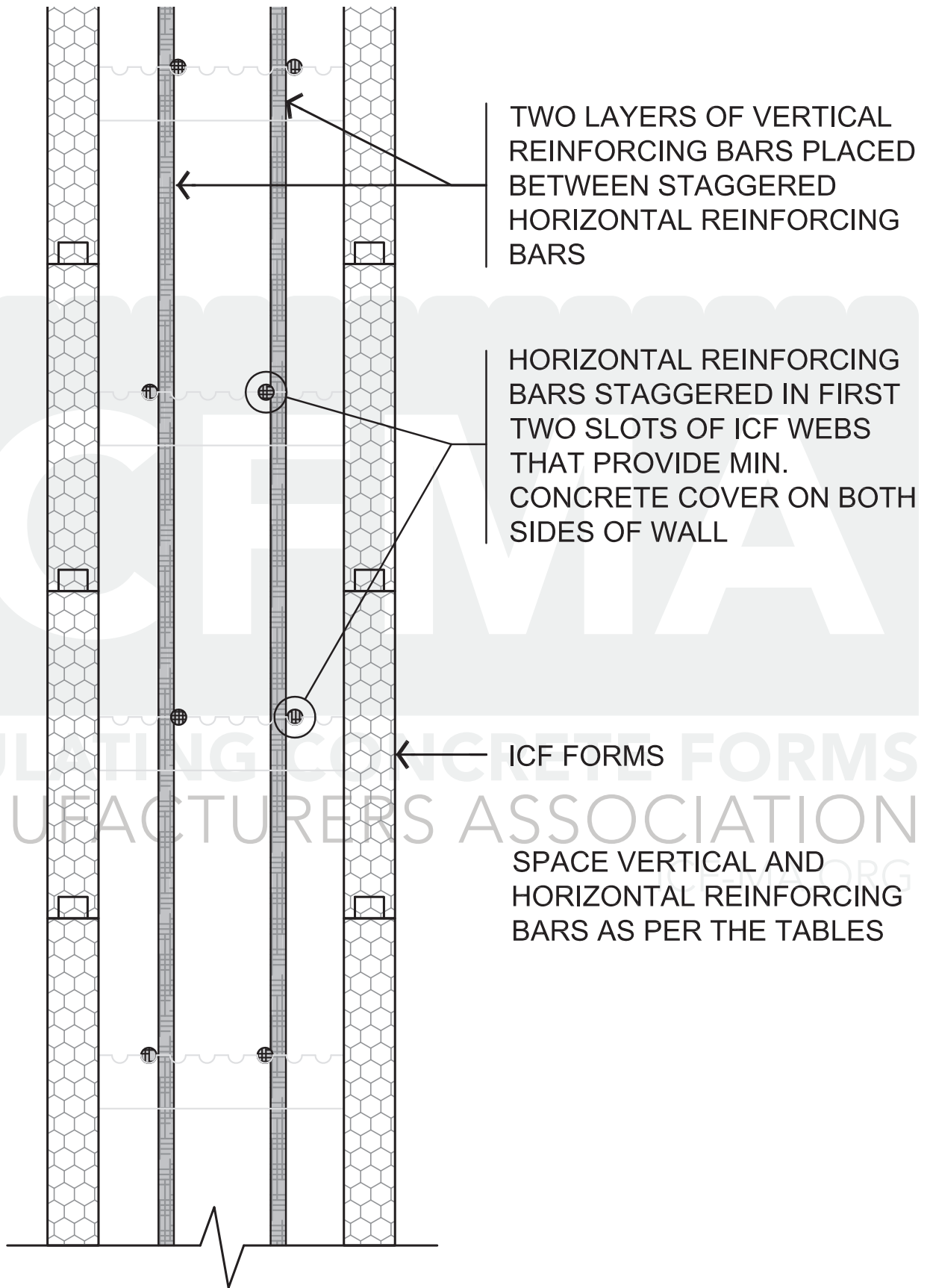

Detail A.2. Above Grade Wall Reinforcing Placement for 12" Thick Walls.

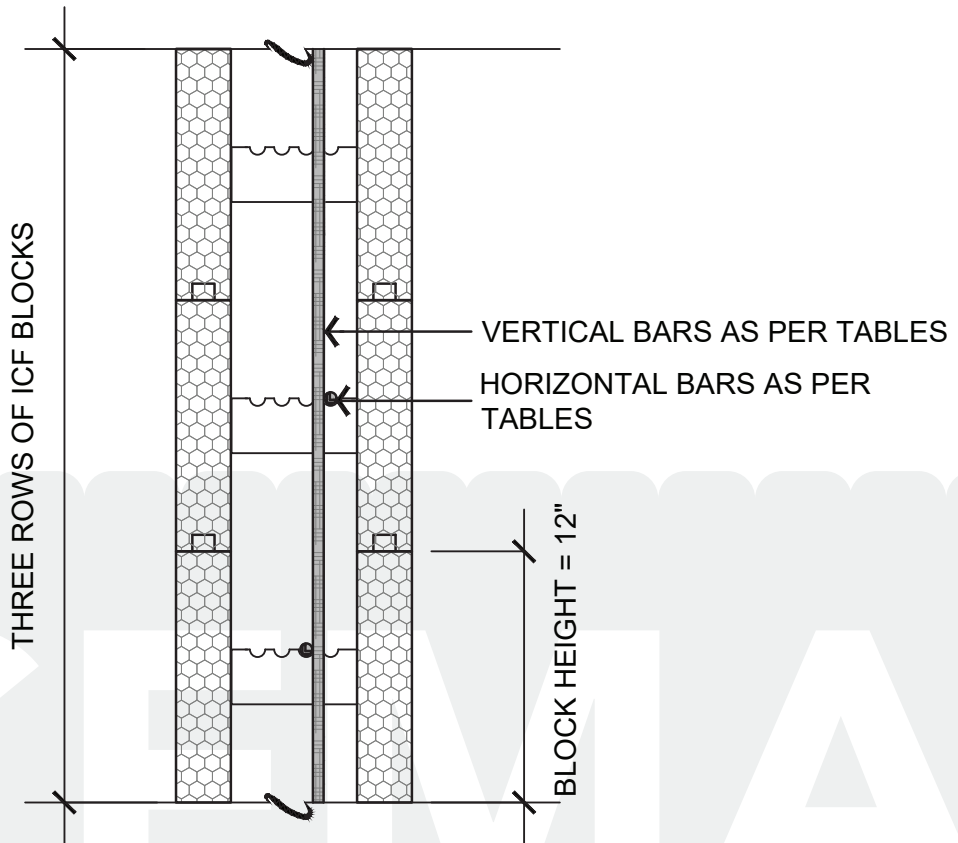

Detail A.3. Alternating Horizontal Bar Spacing of 12" O.C. and 24" O.C. to Achieve an Average Spacing of 18" O.C. (Two Horizontal Bars in Every Three Rows of ICF Blocks)

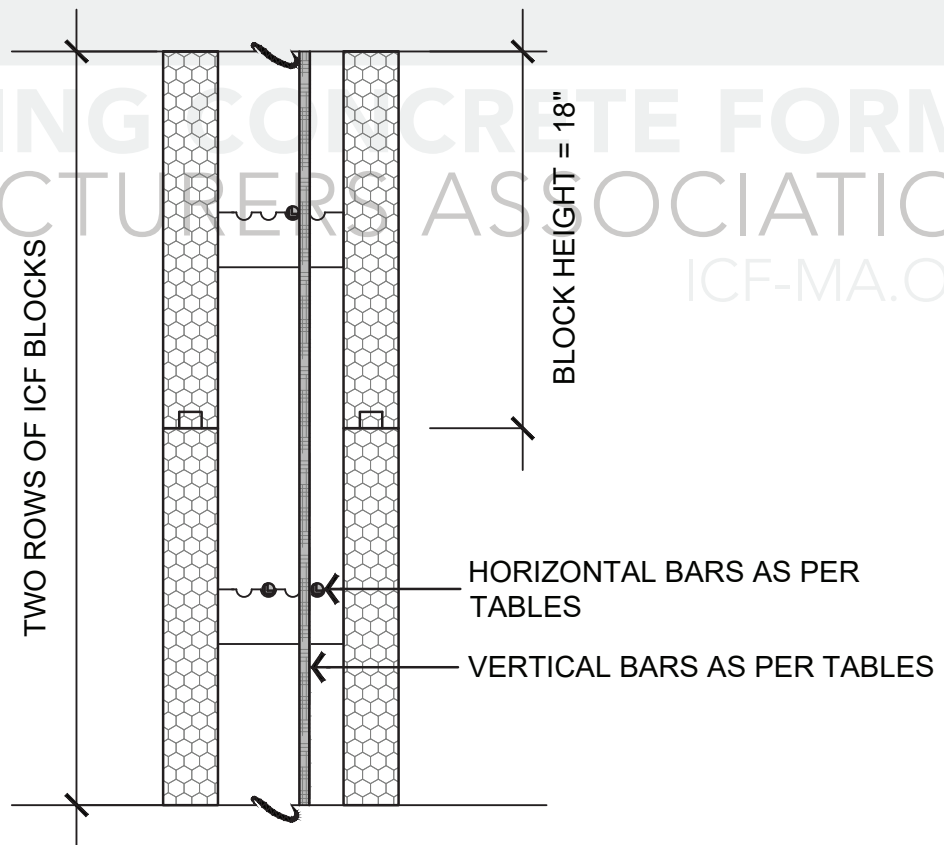

Detail A.4. Three Horizontal Bars in Every Two Rows of 18" High Block to Achieve an Average Spacing of 12" O.C.

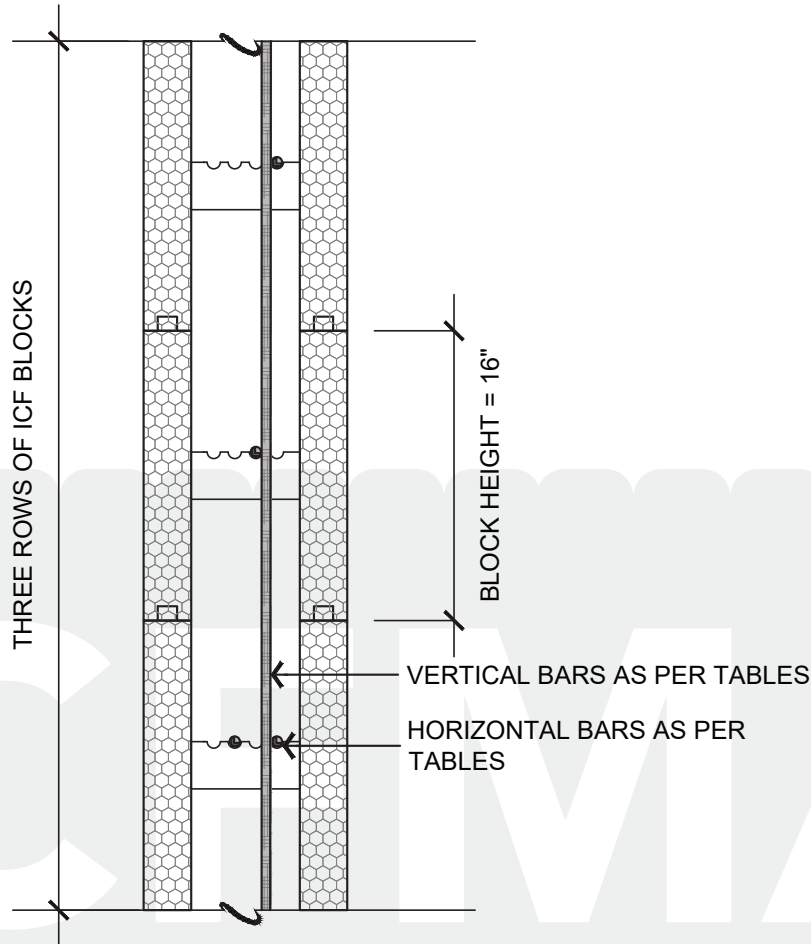

Detail A.5. Four Horizontal Bars in Every Three Rows of 16" High Block to Achieve an Average Spacing of 12" O.C.

INSULATING CONCRETE FORMS
 MANUFACTURERS ASSOCIATION
 ICF-MA.ORG

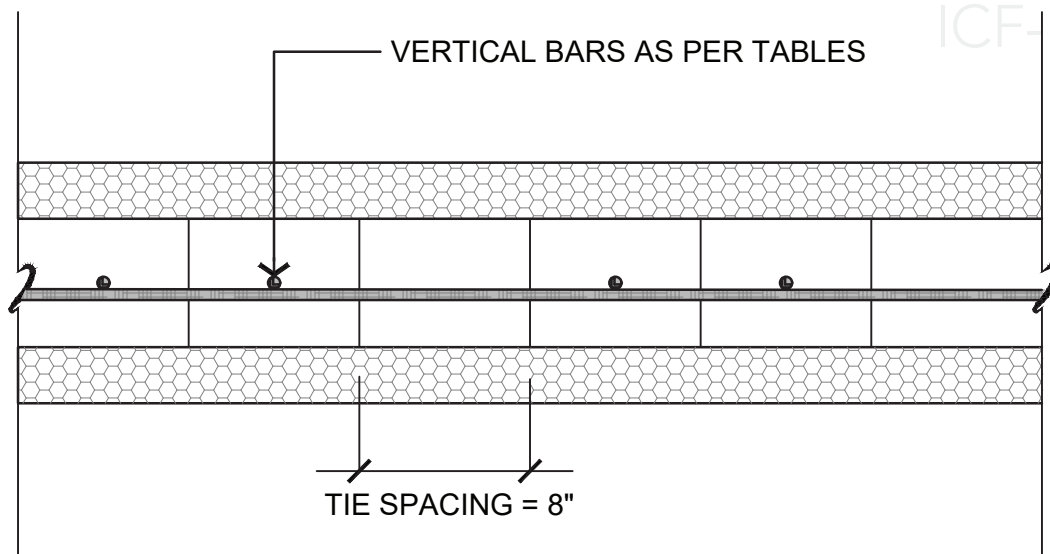

Detail A.6. Alternating Vertical Bar Spacing of 8" O.C. and 16" O.C. to Achieve an Average Spacing of 12" O.C. (Two Vertical Bars in Every Three Cells)

Wall Configurations in a Building Without Walkout Basement

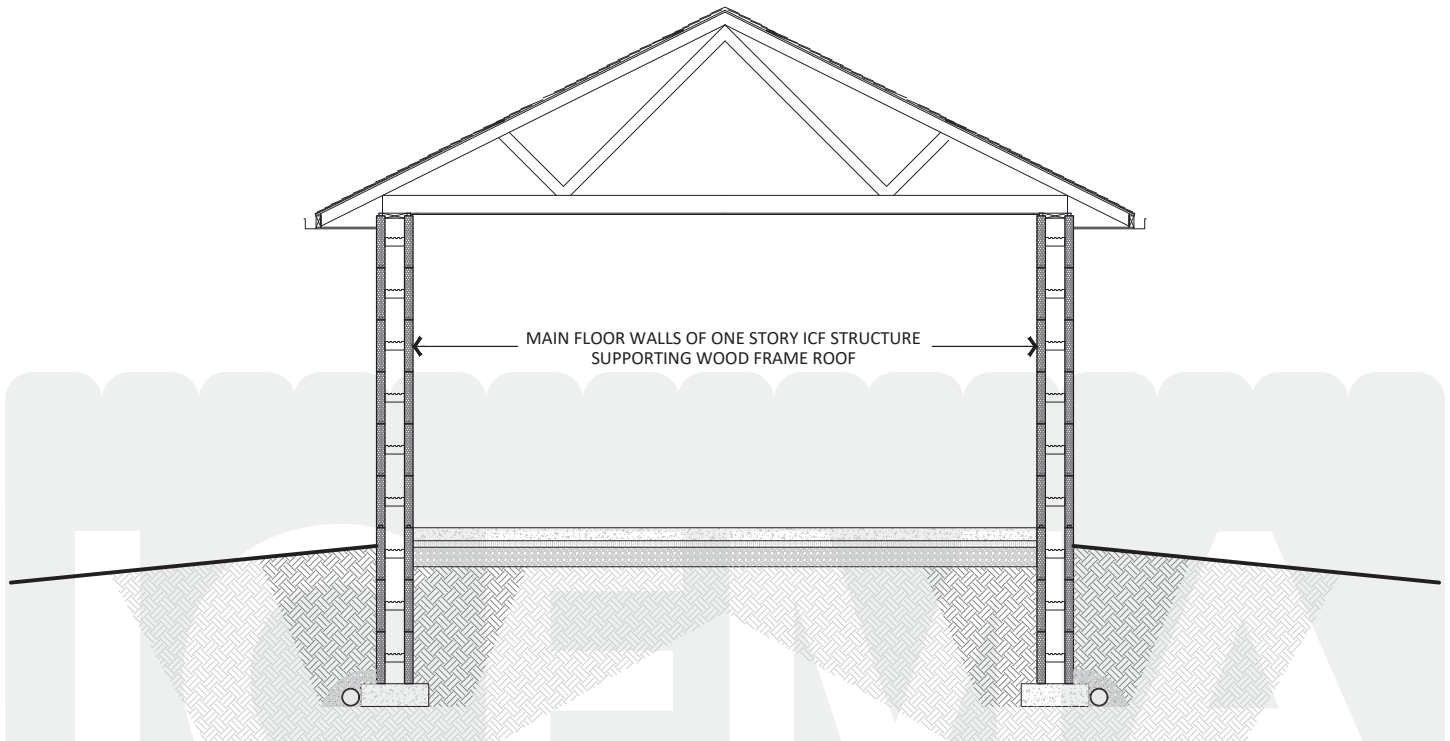

Detail A.7.1. Main Floor Walls of One-Story Structure Supporting Wood Frame Roof.

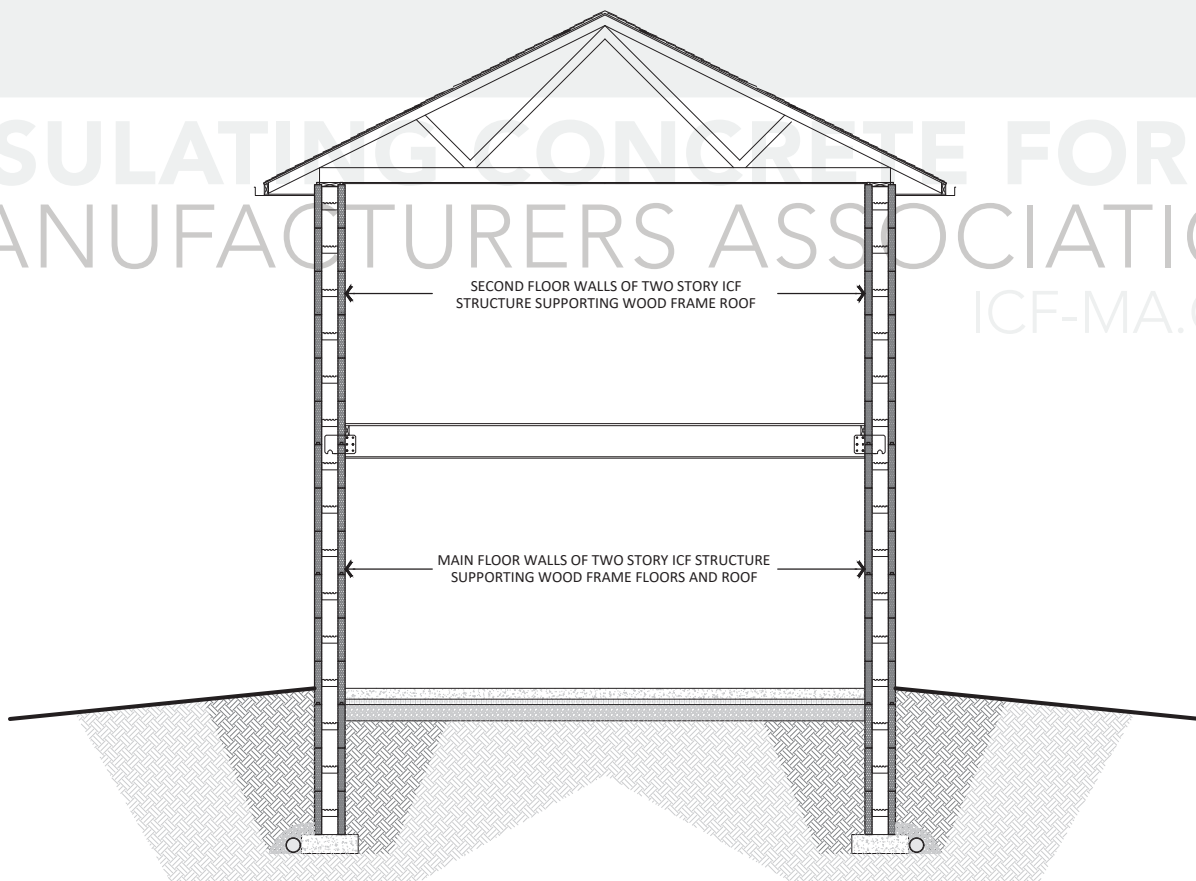

Detail A.7.2. Second Floor Walls of a Two-Story ICF Structure Supporting Wood Frame Roof & Main Floor Walls of a Two-Story ICF Structure Supporting Wood Frame Floors and Roof.

ICFMA

INSULATING CONCRETE FORMS
MANUFACTURERS ASSOCIATION
ICF-MA.ORG

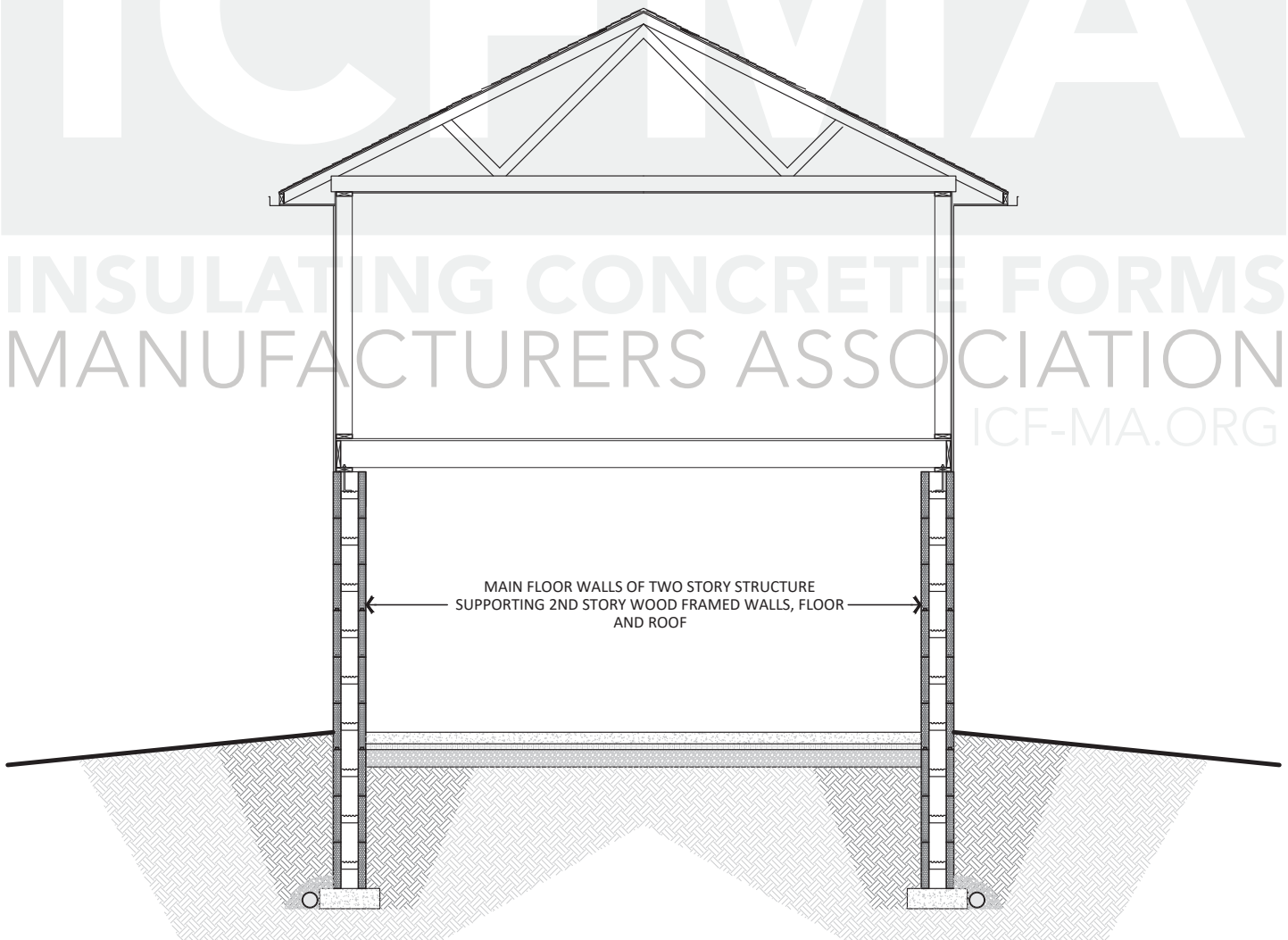

Detail A.7.3. Main Floor Walls of a Two-Story Structure Supporting 2nd Story Wood Frame Walls, Floor and Roof.

Wall Configurations in a Building with Walkout Basement

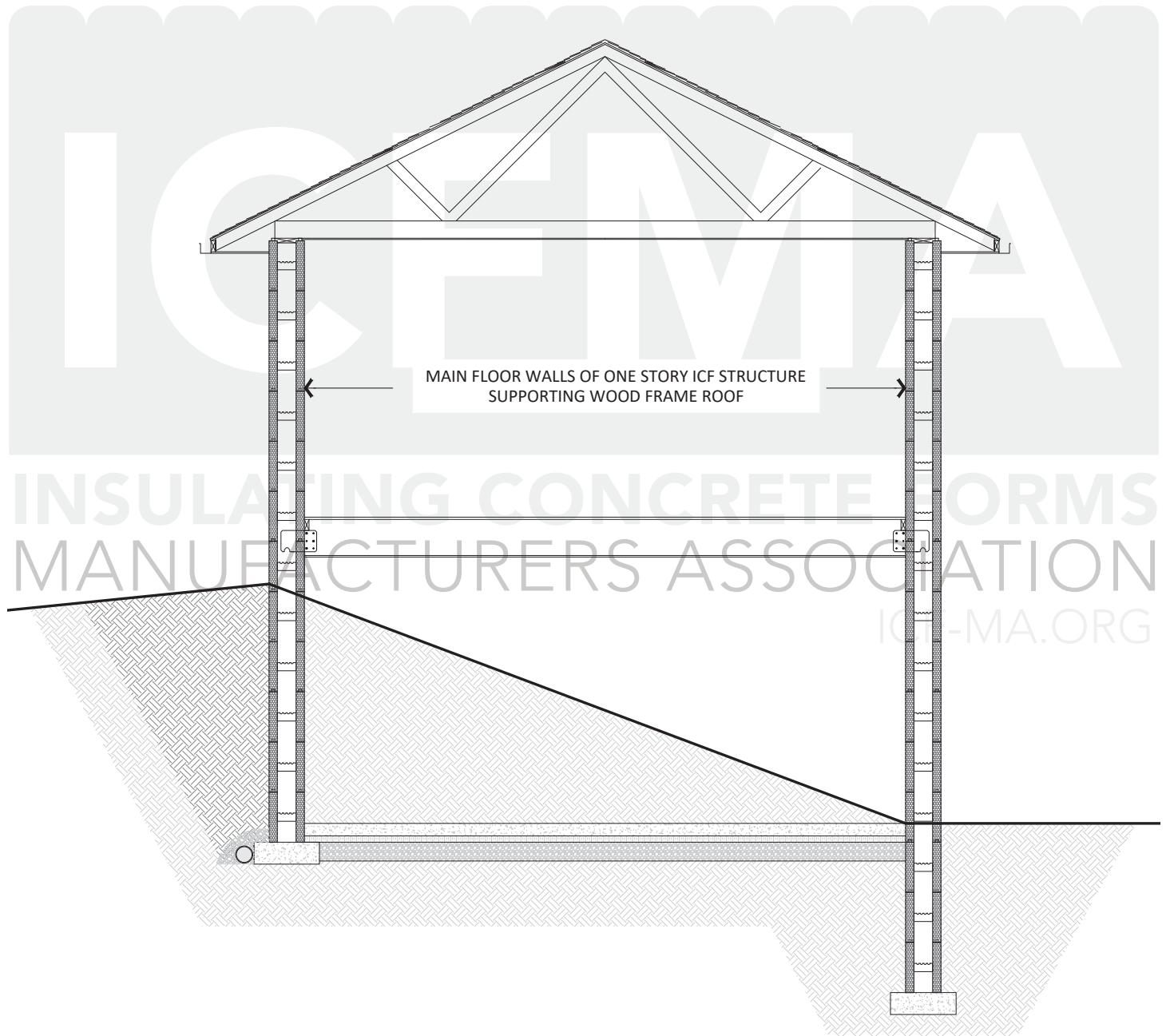

Detail A.8.1. Main Floor Walls of One-Story Structure Supporting Wood Frame Roof.

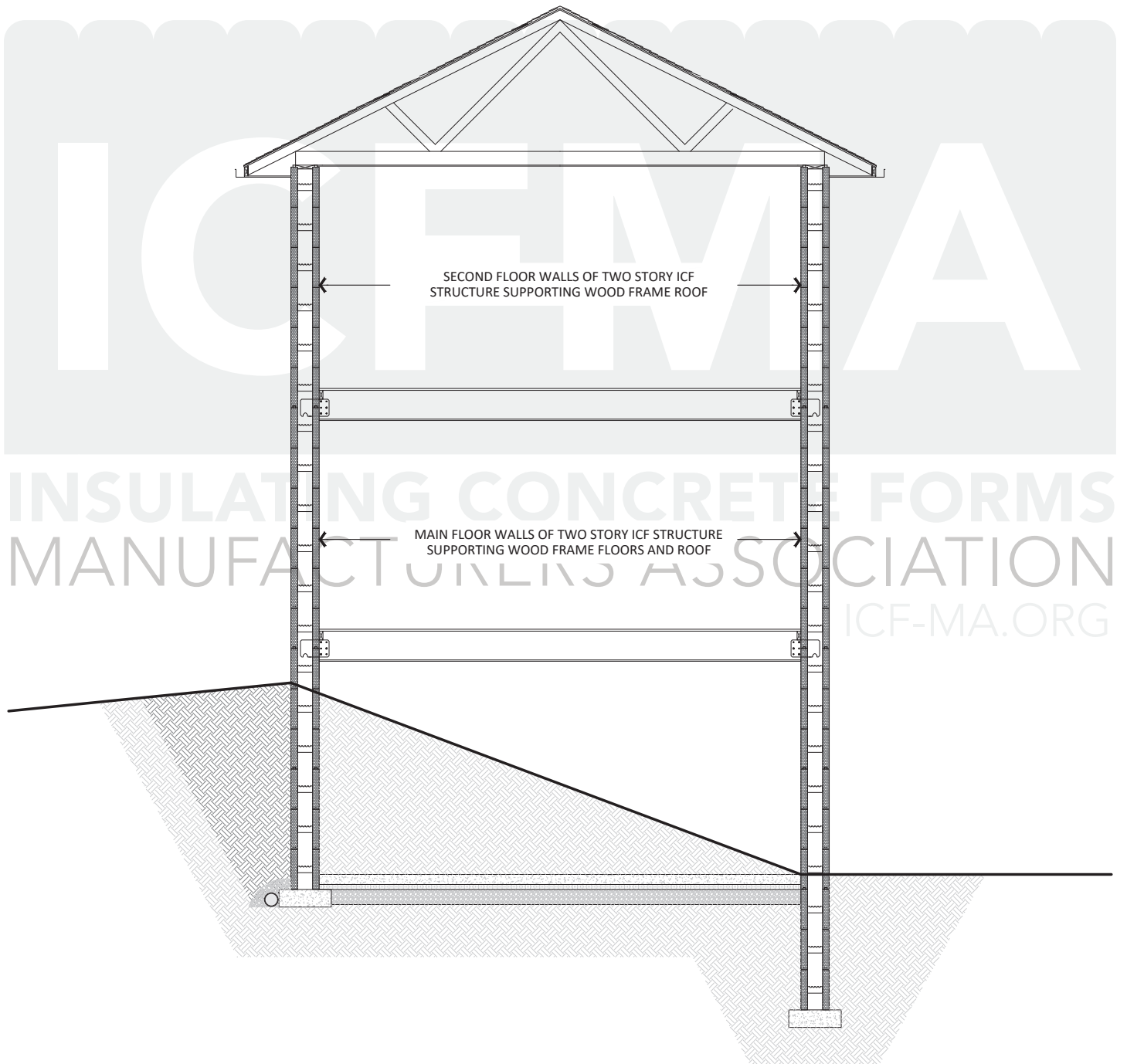

Detail A.8.2. Second Floor Walls of a Two-Story ICF Structure Supporting Wood Frame Roof & Main Floor Walls of a Two-Story ICF Structure Supporting Wood Frame Floors and Roof.

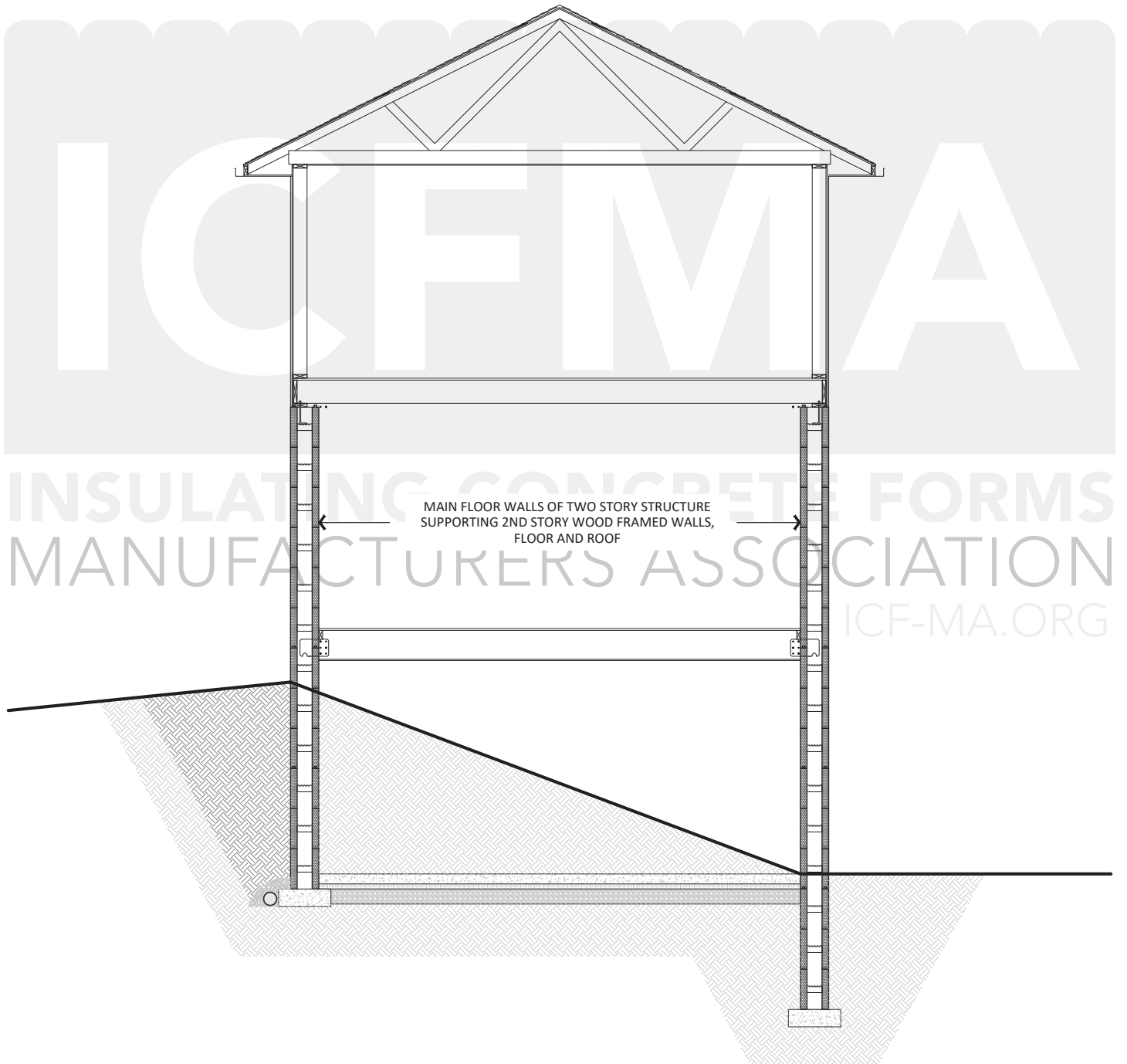

Detail A.8.3. Main Floor Walls of a Two-Story Structure Supporting 2nd Story Wood Frame Walls, Floor and Roof.

Walkout Basement Wall Configurations

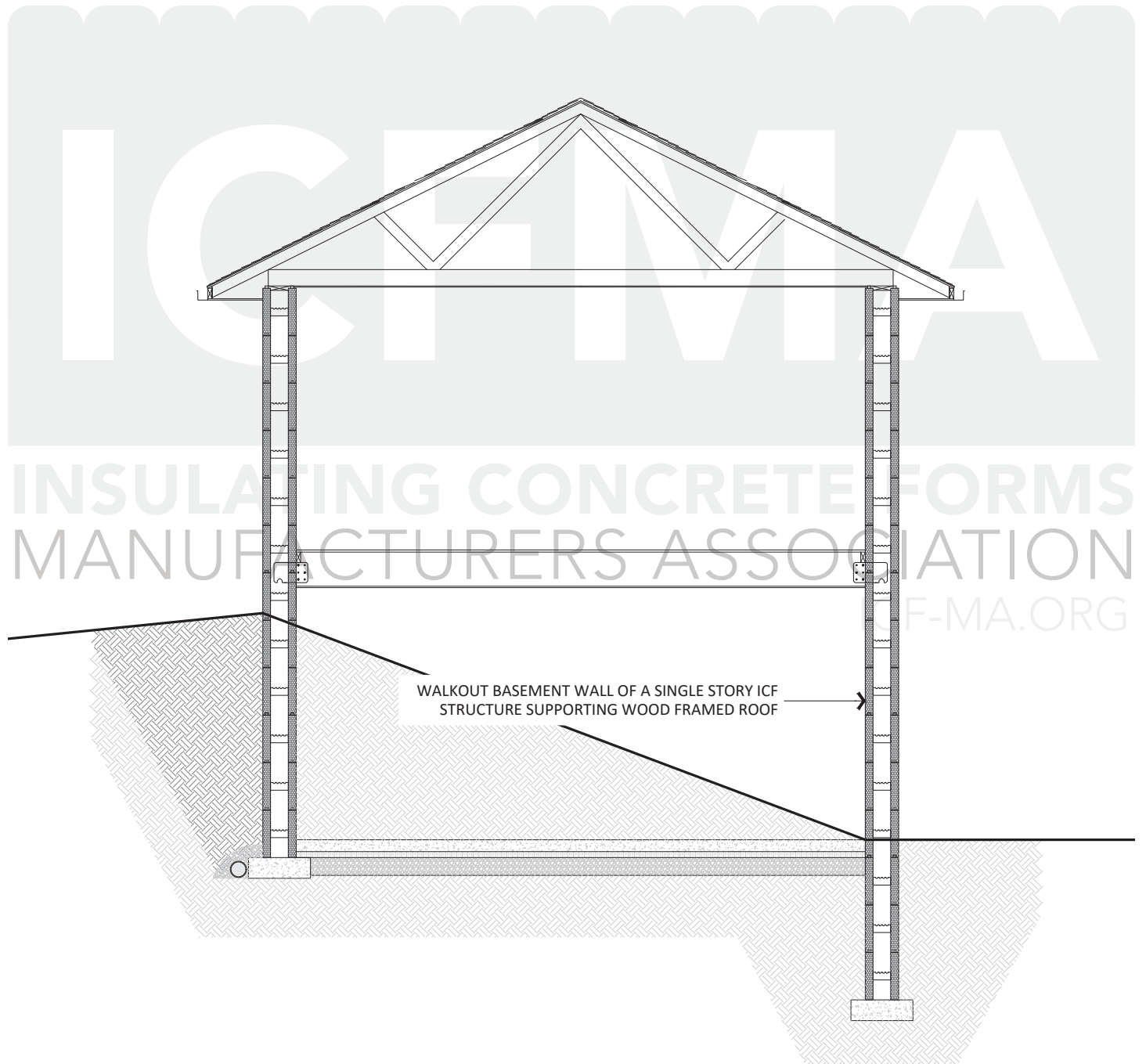

Detail A.9.1. Walkout Basement Wall of a Single Story ICF Structure Supporting Wood Frame Roof.

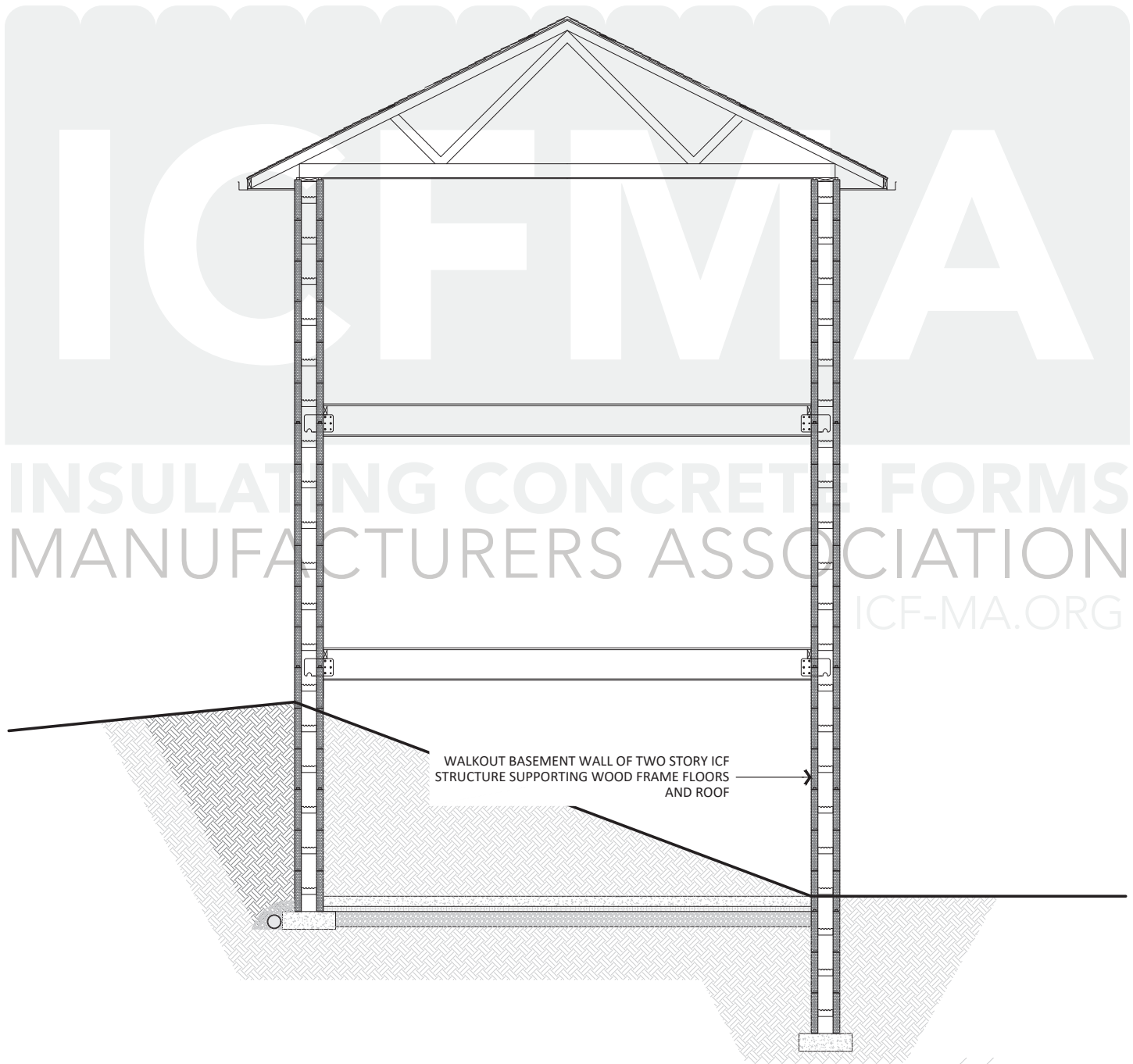

Detail A.9.2. Walkout Basement Wall of a Two-Story ICF Structure Supporting Wood Frame Floors and Roof.

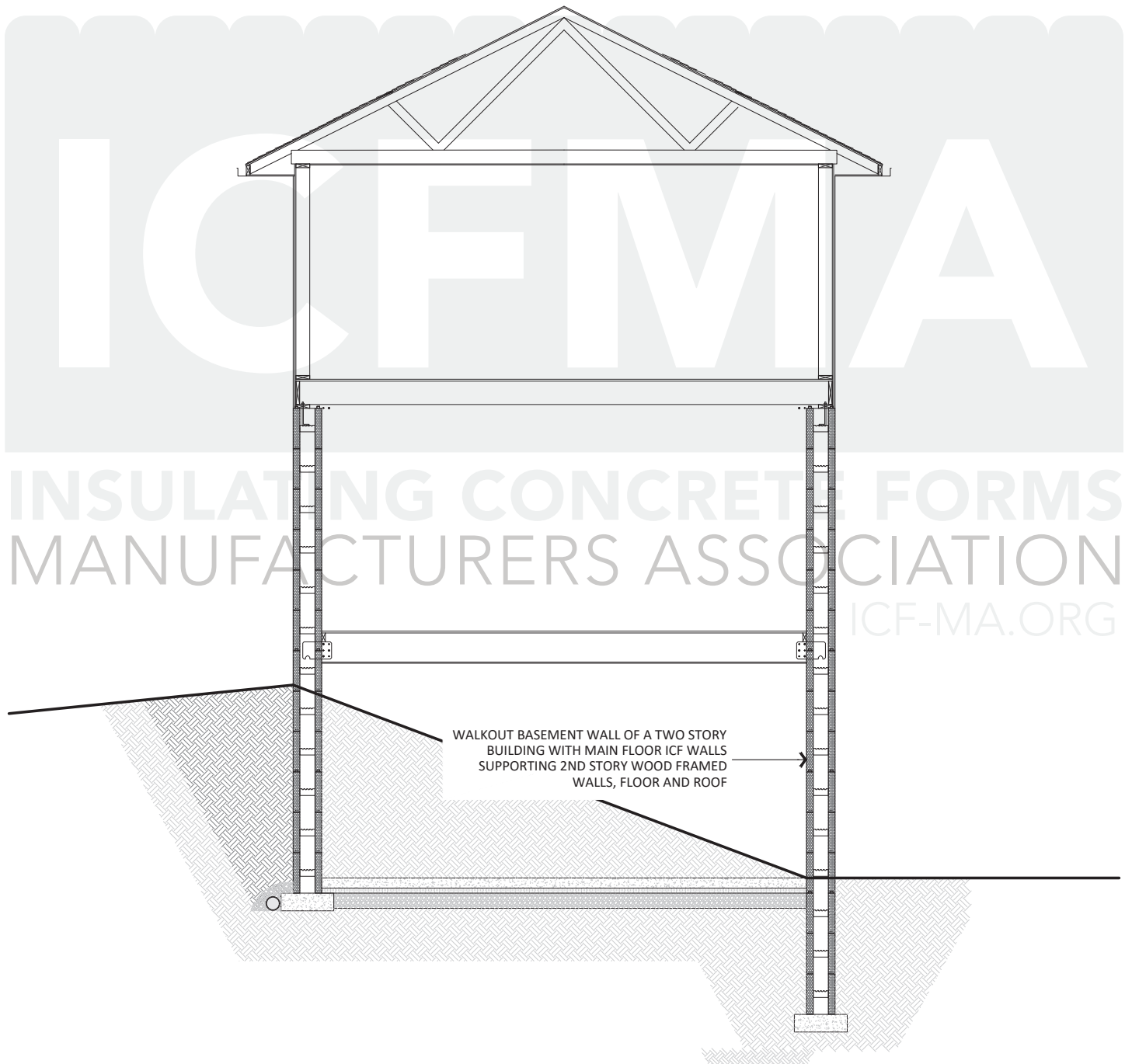

Detail A.9.3. Walkout Basement Wall of a Two-Story Building with Main Floor ICF Walls Supporting Second Story Wood Framed Walls, Floor, and Roof.

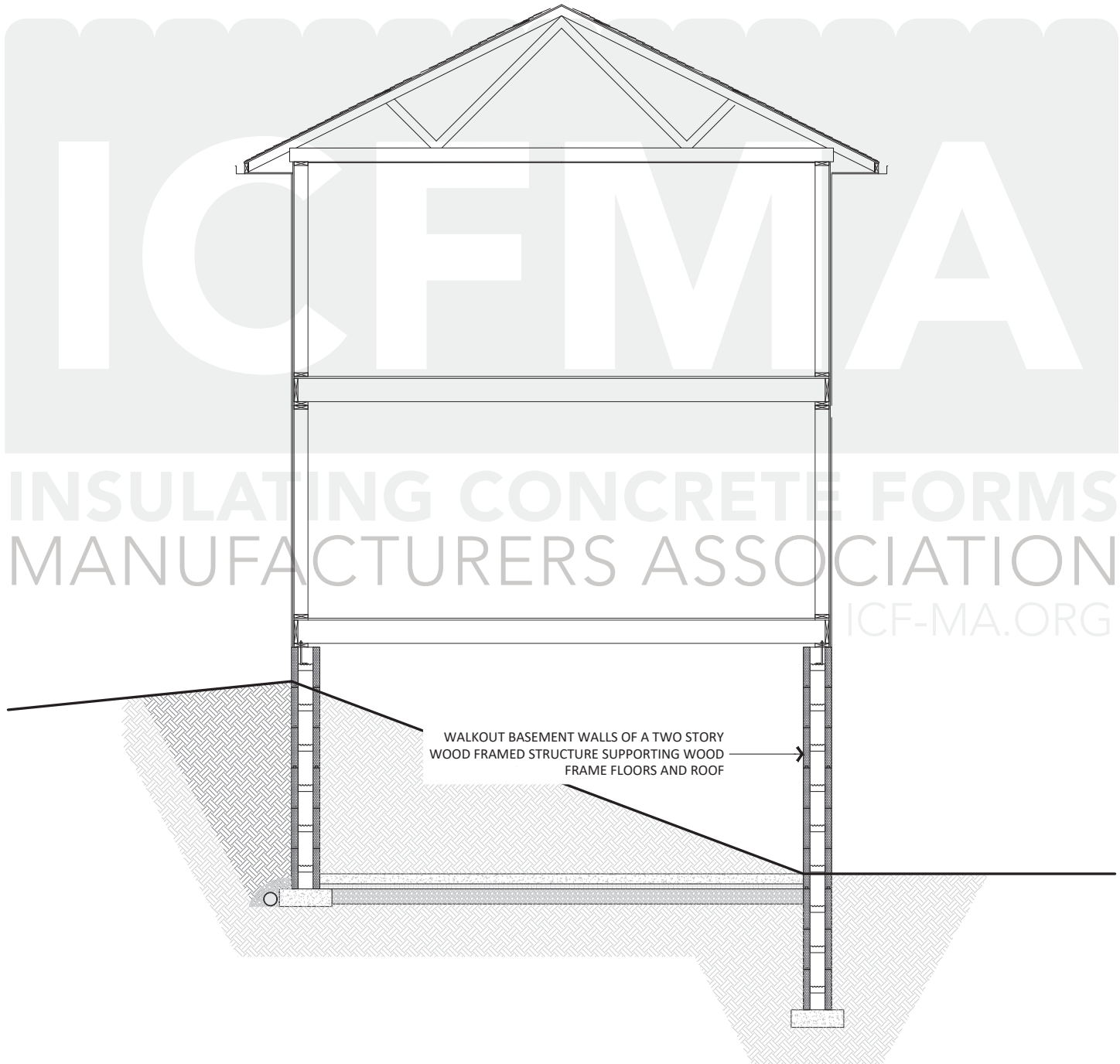

Detail A.9.4. Walkout Basement Wall of a Two-Story Wood Framed Structure Supporting Wood Frame Floors, and Roof. Walls, Floor, and Roof.

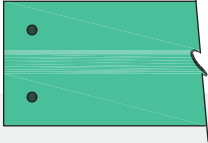
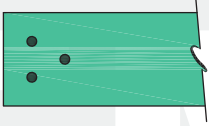
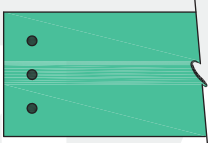
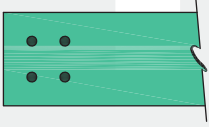
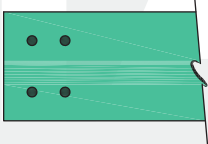
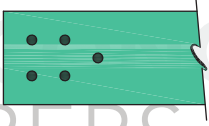
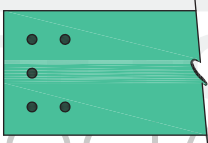
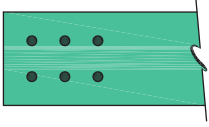
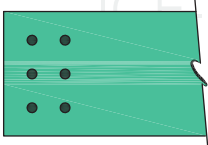
No. OF REINF'G BARS	150 mm (6") THICK	200 - 300 mm (8", 10", 12") THICK
2 BARS		
3 BARS		
4 BARS		
5 BARS		
6 BARS		
<p>REBAR PLACEMENT NOTES:</p> <ol style="list-style-type: none"> 1. PROVIDE 1 1/2" (40mm) COVER TO REINFORCING BARS, TYPICAL. 2. PROVIDE 1 1/2" (40mm) CLEAR SPACING BETWEEN BARS, TYPICAL. 3. PLACE BARS AS CLOSE TO THE SIDES OF THE WALL AS MINIMUM COVER PERMITS. 		

Detail A.10. Shear Wall Concentrated Reinforcing Placement.

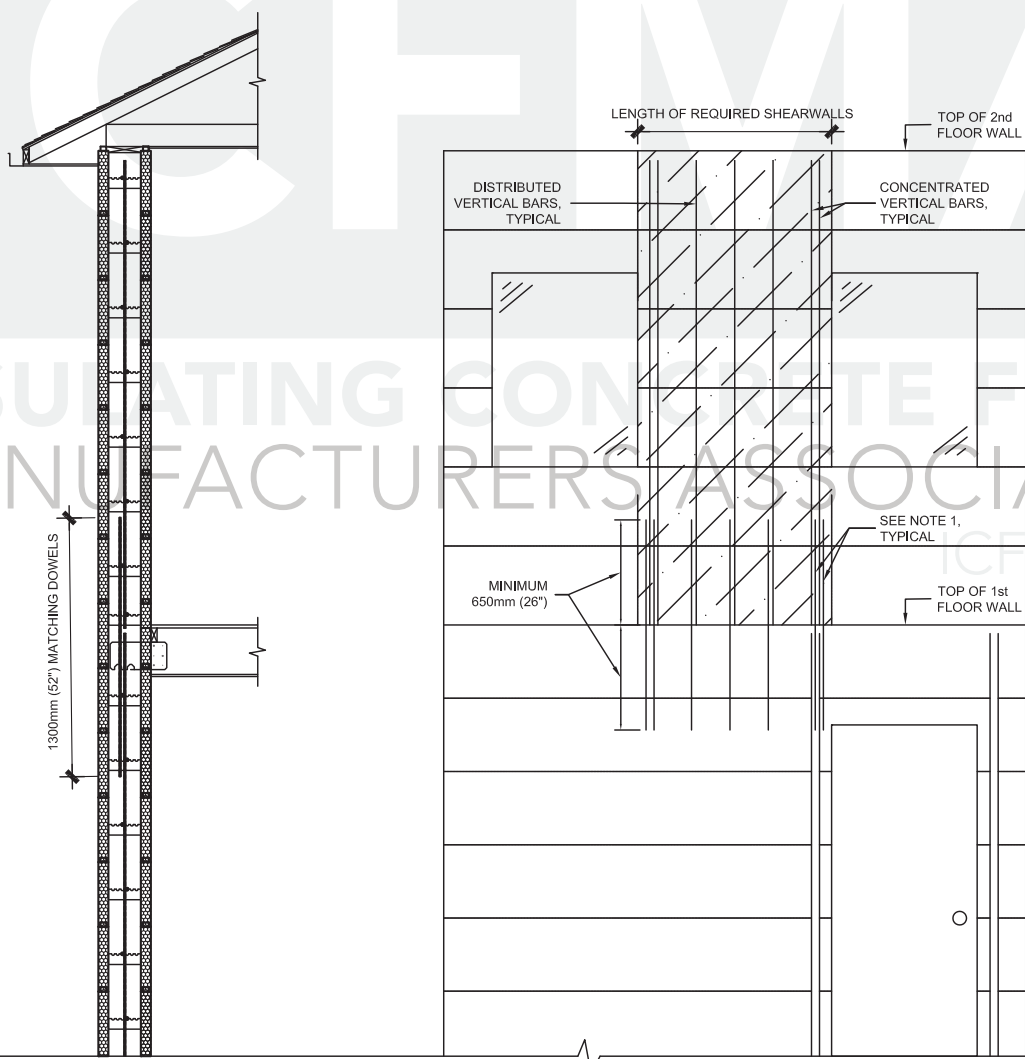
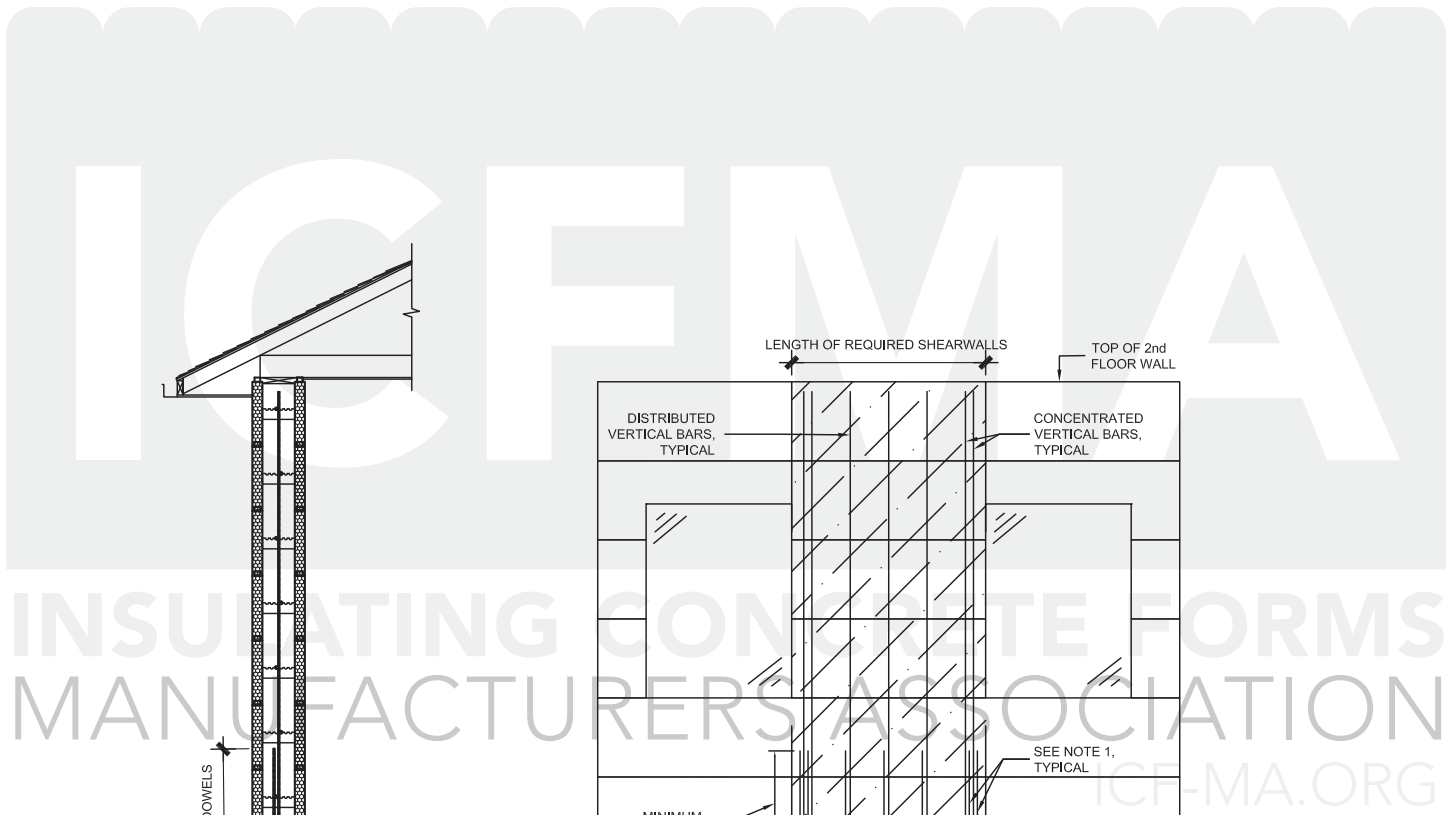

- NOTES
1. PROVIDE 1300mm (52") LONG MATCHING DOWELS INTO WALL BELOW WALL. DOWELS INSTALLED PRIOR TO CONSTRUCTING FLOOR ABOVE

Detail A.11. Shear Wall Dowels.

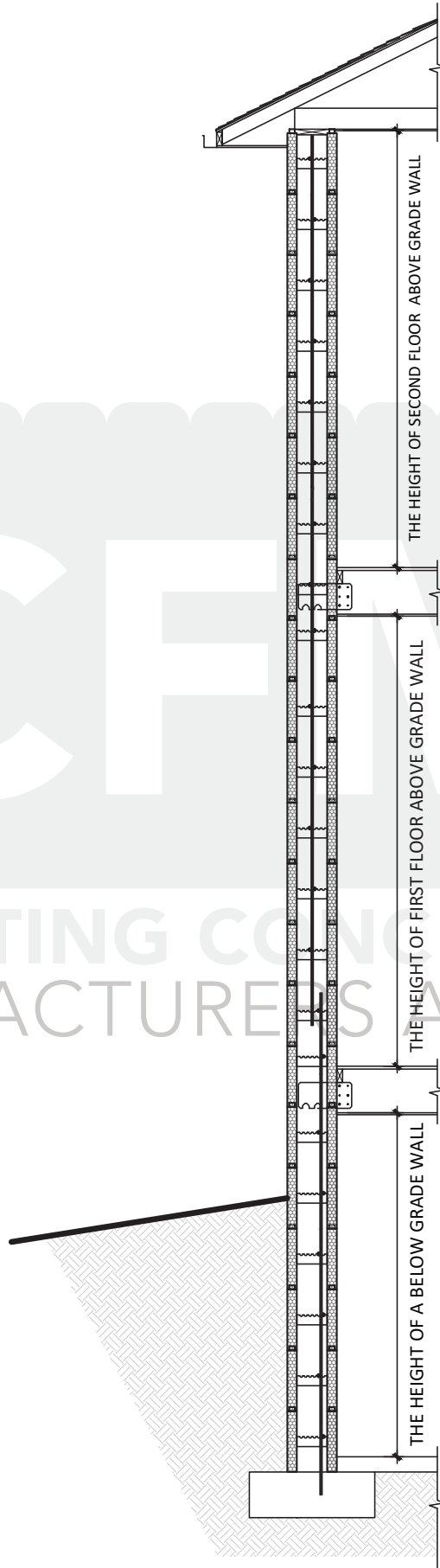

ICFMA
 INSULATING CONCRETE FORMS
 MANUFACTURERS ASSOCIATION
 ICF-MA.ORG

Detail A.12. Above and Below Grade Wall Height

Table B.1.1.– Below Grade Wall Distributed Reinforcement for Seismic Zone Classification, $S_a(0.2) \leq 0.25$ and Hourly Wind Pressure, $q_{1/50} \leq 1.05\text{kPa}$, for ICF Walls with 6" Tie Spacing

Wall Height m (ft)	Backfill Height m (ft)		Vertical Steel (Size and Spacing)																							
			Backfill Equivalent Fluid Density																							
			480 kg/m ³ (30 pcf)								720 kg/m ³ (45 pcf)															
		150 mm (6") Wall			200 mm (8") Wall			250 mm (10") Wall			300 mm (12") Wall			150 mm (6") Wall			200 mm (8") Wall			250 mm (10") Wall			300 mm (12") Wall			
2.44 (8.0)	1.22	(4.0)	10 M @	450	(18)	10 M @	750	(30)	10 M @	900	(36)	10 M @	900	(36)	10 M @	450	(18)	10 M @	600	(24)	10 M @	900	(36)	10 M @	900	(36)
	1.53	(5.0)	10 M @	450	(18)	10 M @	600	(24)	10 M @	900	(36)	10 M @	900	(36)	15 M @	600	(24)	10 M @	450	(18)	10 M @	750	(30)	10 M @	900	(36)
	1.83	(6.0)	15 M @	600	(24)	10 M @	450	(18)	10 M @	750	(30)	10 M @	900	(36)	15 M @	450	(18)	15 M @	750	(30)	10 M @	600	(24)	10 M @	750	(30)
	2.13	(7.0)	15 M @	450	(18)	15 M @	750	(30)	10 M @	600	(24)	10 M @	750	(30)	15 M @	450	(18)	15 M @	600	(24)	10 M @	450	(18)	10 M @	600	(24)
	2.44	(8.0)	15 M @	450	(18)	15 M @	600	(24)	10 M @	450	(18)	10 M @	600	(24)	15 M @	300	(12)	15 M @	450	(18)	15 M @	600	(24)	15 M @	900	(36)
2.74 (9.0)	1.22	(4.0)	15 M @	750	(30)	10 M @	600	(24)	10 M @	900	(36)	10 M @	900	(36)	15 M @	750	(30)	10 M @	600	(24)	10 M @	750	(30)	10 M @	900	(36)
	1.53	(5.0)	15 M @	750	(30)	10 M @	450	(18)	10 M @	750	(30)	10 M @	900	(36)	15 M @	600	(24)	10 M @	450	(18)	10 M @	600	(24)	10 M @	900	(36)
	1.83	(6.0)	15 M @	600	(24)	15 M @	900	(36)	10 M @	600	(24)	10 M @	900	(36)	15 M @	450	(18)	15 M @	750	(30)	10 M @	450	(18)	10 M @	600	(24)
	2.13	(7.0)	15 M @	450	(18)	15 M @	750	(30)	10 M @	450	(18)	10 M @	750	(30)	15 M @	450	(18)	15 M @	600	(24)	15 M @	750	(30)	15 M @	900	(36)
	2.44	(8.0)	15 M @	300	(12)	15 M @	600	(24)	15 M @	900	(36)	15 M @	900	(36)	15 M @	300	(12)	15 M @	450	(18)	15 M @	600	(24)	15 M @	750	(30)
2.74	(9.0)	15 M @	300	(12)	15 M @	450	(18)	15 M @	750	(30)	15 M @	900	(36)	15 M @	150	(6)	15 M @	450	(18)	15 M @	450	(18)	15 M @	600	(24)	
3.05 (10.0)	1.22	(4.0)	15 M @	750	(30)	10 M @	600	(24)	10 M @	900	(36)	10 M @	900	(36)	15 M @	750	(30)	10 M @	450	(18)	10 M @	750	(30)	10 M @	900	(36)
	1.53	(5.0)	15 M @	750	(30)	15 M @	900	(36)	10 M @	750	(30)	10 M @	900	(36)	15 M @	600	(24)	15 M @	750	(30)	10 M @	600	(24)	10 M @	750	(30)
	1.83	(6.0)	15 M @	450	(18)	15 M @	750	(30)	10 M @	600	(24)	10 M @	750	(30)	15 M @	450	(18)	15 M @	600	(24)	10 M @	450	(18)	10 M @	600	(24)
	2.13	(7.0)	15 M @	450	(18)	15 M @	600	(24)	10 M @	450	(18)	10 M @	600	(24)	15 M @	300	(12)	15 M @	450	(18)	15 M @	750	(30)	15 M @	900	(36)
	2.44	(8.0)	15 M @	300	(12)	15 M @	450	(18)	15 M @	750	(30)	15 M @	900	(36)	15 M @	300	(12)	15 M @	450	(18)	15 M @	600	(24)	15 M @	750	(30)
	2.74	(9.0)	15 M @	150	(6)	15 M @	450	(18)	15 M @	600	(24)	15 M @	750	(30)	15 M @	150	(6)	15 M @	300	(12)	15 M @	450	(18)	15 M @	600	(24)
	3.05	(10.0)	15 M @	150	(6)	15 M @	300	(12)	15 M @	450	(18)	15 M @	750	(30)	15 M @	150	(6)	15 M @	300	(12)	15 M @	450	(18)	15 M @	450	(18)
3.35 (11.0)	1.22	(4.0)	15 M @	750	(30)	10 M @	450	(18)	10 M @	750	(30)	10 M @	900	(36)	15 M @	600	(24)	10 M @	450	(18)	10 M @	750	(30)	10 M @	900	(36)
	1.53	(5.0)	15 M @	600	(24)	15 M @	900	(36)	10 M @	600	(24)	10 M @	900	(36)	15 M @	450	(18)	15 M @	750	(30)	10 M @	450	(18)	10 M @	750	(30)
	1.83	(6.0)	15 M @	450	(18)	15 M @	750	(30)	10 M @	450	(18)	10 M @	750	(30)	15 M @	450	(18)	15 M @	600	(24)	10 M @	450	(18)	10 M @	600	(24)
	2.13	(7.0)	15 M @	300	(12)	15 M @	600	(24)	15 M @	750	(30)	15 M @	900	(36)	15 M @	300	(12)	15 M @	450	(18)	15 M @	600	(24)	15 M @	900	(36)
	2.44	(8.0)	15 M @	300	(12)	15 M @	450	(18)	15 M @	600	(24)	15 M @	900	(36)	15 M @	150	(6)	15 M @	450	(18)	15 M @	450	(18)	15 M @	600	(24)
	2.74	(9.0)	15 M @	150	(6)	15 M @	300	(12)	15 M @	600	(24)	15 M @	750	(30)	15 M @	150	(6)	15 M @	300	(12)	15 M @	450	(18)	15 M @	450	(18)
	3.05	(10.0)	15 M @	150	(6)	15 M @	300	(12)	15 M @	450	(18)	15 M @	600	(24)	15 M @	150	(6)	15 M @	150	(6)	15 M @	300	(12)	15 M @	450	(18)
3.35	(11.0)	15 M @	150	(6)	15 M @	300	(12)	15 M @	300	(12)	15 M @	450	(18)	15 M @	150	(6)	15 M @	150	(6)	15 M @	300	(12)	15 M @	300	(12)	
3.66 (12.0)	1.22	(4.0)	15 M @	600	(24)	10 M @	450	(18)	10 M @	750	(30)	10 M @	900	(36)	15 M @	600	(24)	15 M @	750	(30)	10 M @	600	(24)	10 M @	900	(36)
	1.53	(5.0)	15 M @	600	(24)	15 M @	750	(30)	10 M @	600	(24)	10 M @	900	(36)	15 M @	450	(18)	15 M @	600	(24)	10 M @	450	(18)	10 M @	750	(30)
	1.83	(6.0)	15 M @	450	(18)	15 M @	600	(24)	10 M @	450	(18)	10 M @	600	(24)	15 M @	300	(12)	15 M @	600	(24)	15 M @	750	(30)	15 M @	900	(36)
	2.13	(7.0)	15 M @	300	(12)	15 M @	600	(24)	15 M @	750	(30)	15 M @	900	(36)	15 M @	300	(12)	15 M @	450	(18)	15 M @	600	(24)	15 M @	750	(30)
	2.44	(8.0)	15 M @	150	(6)	15 M @	450	(18)	15 M @	600	(24)	15 M @	900	(36)	15 M @	150	(6)	15 M @	300	(12)	15 M @	450	(18)	15 M @	600	(24)
	2.74	(9.0)	15 M @	150	(6)	15 M @	300	(12)	15 M @	450	(18)	15 M @	600	(24)	15 M @	150	(6)	15 M @	300	(12)	15 M @	450	(18)	15 M @	450	(18)
	3.05	(10.0)	15 M @	150	(6)	15 M @	300	(12)	15 M @	300	(12)	15 M @	450	(18)	15 M @	150	(6)	15 M @	150	(6)	15 M @	300	(12)	15 M @	450	(18)
	3.35	(11.0)	15 M @	150	(6)	15 M @	150	(6)	15 M @	300	(12)	15 M @	450	(18)				15 M @	150	(6)	15 M @	300	(12)	15 M @	300	(12)
	3.66	(12.0)				15 M @	150	(6)	15 M @	300	(12)	15 M @	300	(12)				15 M @	150	(6)	15 M @	150	(6)	15 M @	300	(12)
Horizontal Reinforcement	Block Height of 12" and 18"		10 M @	900	(36)	10 M @	900	(36)	10 M @	900	(36)	10 M @	900	(36)	10 M @	900	(36)	10 M @	900	(36)	10 M @	900	(36)	10 M @	900	(36)
	Block Height of 16"		10 M @	800	(32)	10 M @	800	(32)	10 M @	800	(32)	10 M @	800	(32)	10 M @	800	(32)	10 M @	800	(32)	10 M @	800	(32)	10 M @	800	(32)

NOTES

1. For highlighted data, where the below grade wall meets all the requirements of NBC Part 9 for a solid concrete foundation wall and supports only wood frame construction above, a 20MPa unreinforced wall is adequate as per 2015 NBC table 9.15.4.2.A. Provide the reinforcing shown for walls supporting ICF walls above or with brick veneer supported with the brick ledge form.
2. Below grade walls supporting "Drained Earth" in accordance with 2015 NBC 9.4.4.6 may be designed for an equivalent fluid pressure of 480 kg/m³.
3. This table is to be used in conjunction with the "Design Limitations" and "Below Grade Reinforcement Placement" drawing.

Table B.1.1. Continued – Below Grade Wall Distributed Reinforcement for Seismic Zone Classification, $S_a(0.2) \leq 0.25$ and Hourly Wind Pressure, $q_{1/50} \leq 1.05\text{kPa}$, for ICF Walls with 6” Tie Spacing

Wall Height m (ft)	Backfill Height m (ft)	Vertical Steel (Size and Spacing)															
		Backfill Equivalent Fluid Density															
		960 kg/m3 (60 pcf)								1200 kg/m3 (75 pcf)							
		150 mm (6") Wall		200 mm (8") Wall		250 mm (10") Wall		300 mm (12") Wall		150 mm (6") Wall		200 mm (8") Wall		250 mm (10") Wall		300 mm (12") Wall	
2.44 (8.0)	1.22 (4.0)	15 M @	600 (24)	10 M @	450 (18)	10 M @	750 (30)	10 M @	900 (36)	15 M @	600 (24)	10 M @	450 (18)	10 M @	750 (30)	10 M @	900 (36)
	1.53 (5.0)	15 M @	600 (24)	10 M @	450 (18)	10 M @	600 (24)	10 M @	900 (36)	15 M @	450 (18)	15 M @	750 (30)	15 M @	900 (36)	10 M @	750 (30)
	1.83 (6.0)	15 M @	450 (18)	15 M @	600 (24)	10 M @	450 (18)	10 M @	600 (24)	15 M @	450 (18)	15 M @	450 (18)	15 M @	750 (30)	15 M @	900 (36)
	2.13 (7.0)	15 M @	300 (12)	15 M @	450 (18)	15 M @	600 (24)	15 M @	900 (36)	15 M @	300 (12)	15 M @	450 (18)	15 M @	600 (24)	15 M @	750 (30)
	2.44 (8.0)	15 M @	300 (12)	15 M @	450 (18)	15 M @	450 (18)	15 M @	750 (30)	15 M @	150 (6)	15 M @	300 (12)	15 M @	450 (18)	15 M @	600 (24)
2.74 (9.0)	1.22 (4.0)	15 M @	600 (24)	10 M @	450 (18)	10 M @	600 (24)	10 M @	900 (36)	15 M @	600 (24)	15 M @	900 (36)	10 M @	450 (18)	10 M @	900 (36)
	1.53 (5.0)	15 M @	450 (18)	15 M @	600 (24)	15 M @	600 (24)	10 M @	750 (30)	15 M @	450 (18)	15 M @	750 (30)	15 M @	900 (36)	10 M @	600 (24)
	1.83 (6.0)	15 M @	450 (18)	15 M @	450 (18)	15 M @	750 (30)	10 M @	600 (24)	15 M @	450 (18)	15 M @	450 (18)	15 M @	600 (24)	15 M @	900 (36)
	2.13 (7.0)	15 M @	300 (12)	15 M @	450 (18)	15 M @	600 (24)	15 M @	750 (30)	15 M @	300 (12)	15 M @	450 (18)	15 M @	450 (18)	15 M @	600 (24)
	2.44 (8.0)	15 M @	150 (6)	15 M @	300 (12)	15 M @	450 (18)	15 M @	600 (24)	15 M @	150 (6)	15 M @	300 (12)	15 M @	450 (18)	15 M @	450 (18)
	2.74 (9.0)	15 M @	150 (6)	15 M @	300 (12)	15 M @	450 (18)	15 M @	450 (18)	15 M @	150 (6)	15 M @	300 (12)	15 M @	300 (12)	15 M @	300 (12)
3.05 (10.0)	1.22 (4.0)	15 M @	600 (24)	10 M @	450 (18)	10 M @	600 (24)	10 M @	900 (36)	15 M @	600 (24)	15 M @	750 (30)	15 M @	900 (36)	10 M @	900 (36)
	1.53 (5.0)	15 M @	450 (18)	15 M @	600 (24)	10 M @	450 (18)	10 M @	750 (30)	15 M @	450 (18)	15 M @	600 (24)	15 M @	900 (36)	10 M @	600 (24)
	1.83 (6.0)	15 M @	450 (18)	15 M @	450 (18)	15 M @	750 (30)	15 M @	900 (36)	15 M @	300 (12)	15 M @	450 (18)	15 M @	600 (24)	15 M @	900 (36)
	2.13 (7.0)	15 M @	300 (12)	15 M @	450 (18)	15 M @	600 (24)	15 M @	750 (30)	15 M @	150 (6)	15 M @	300 (12)	15 M @	450 (18)	15 M @	600 (24)
	2.44 (8.0)	15 M @	150 (6)	15 M @	300 (12)	15 M @	450 (18)	15 M @	600 (24)	15 M @	150 (6)	15 M @	300 (12)	15 M @	300 (12)	15 M @	450 (18)
	2.74 (9.0)	15 M @	150 (6)	15 M @	150 (6)	15 M @	300 (12)	15 M @	450 (18)	15 M @	150 (6)	15 M @	150 (6)	15 M @	300 (12)	15 M @	300 (12)
	3.05 (10.0)	15 M @	150 (6)	15 M @	150 (6)	15 M @	300 (12)	15 M @	300 (12)			15 M @	150 (6)	15 M @	300 (12)	15 M @	300 (12)
3.35 (11.0)	1.22 (4.0)	15 M @	600 (24)	15 M @	600 (24)	10 M @	600 (24)	10 M @	900 (36)	15 M @	600 (24)	15 M @	750 (30)	15 M @	900 (36)	10 M @	750 (30)
	1.53 (5.0)	15 M @	450 (18)	15 M @	600 (24)	15 M @	900 (36)	10 M @	600 (24)	15 M @	450 (18)	15 M @	600 (24)	15 M @	750 (30)	10 M @	600 (24)
	1.83 (6.0)	15 M @	450 (18)	15 M @	450 (18)	15 M @	750 (30)	15 M @	900 (36)	15 M @	300 (12)	15 M @	450 (18)	15 M @	600 (24)	15 M @	750 (30)
	2.13 (7.0)	15 M @	300 (12)	15 M @	450 (18)	15 M @	450 (18)	15 M @	750 (30)	15 M @	150 (6)	15 M @	300 (12)	15 M @	450 (18)	15 M @	600 (24)
	2.44 (8.0)	15 M @	150 (6)	15 M @	300 (12)	15 M @	450 (18)	15 M @	450 (18)	15 M @	150 (6)	15 M @	300 (12)	15 M @	300 (12)	15 M @	450 (18)
	2.74 (9.0)	15 M @	150 (6)	15 M @	150 (6)	15 M @	300 (12)	15 M @	450 (18)			15 M @	150 (6)	15 M @	300 (12)	15 M @	300 (12)
	3.05 (10.0)			15 M @	150 (6)	15 M @	300 (12)	15 M @	300 (12)			15 M @	150 (6)	15 M @	150 (6)	15 M @	300 (12)
	3.35 (11.0)			15 M @	150 (6)	15 M @	150 (6)	15 M @	300 (12)			15 M @	150 (6)	15 M @	150 (6)	15 M @	300 (12)
3.66 (12.0)	1.22 (4.0)	15 M @	600 (24)	15 M @	600 (24)	10 M @	600 (24)	10 M @	900 (36)	15 M @	450 (18)	15 M @	750 (30)	15 M @	900 (36)	10 M @	750 (30)
	1.53 (5.0)	15 M @	450 (18)	15 M @	450 (18)	15 M @	750 (30)	10 M @	600 (24)	15 M @	450 (18)	15 M @	450 (18)	15 M @	750 (30)	15 M @	900 (36)
	1.83 (6.0)	15 M @	300 (12)	15 M @	450 (18)	15 M @	600 (24)	15 M @	900 (36)	15 M @	300 (12)	15 M @	450 (18)	15 M @	600 (24)	15 M @	750 (30)
	2.13 (7.0)	15 M @	150 (6)	15 M @	300 (12)	15 M @	450 (18)	15 M @	600 (24)	15 M @	150 (6)	15 M @	300 (12)	15 M @	450 (18)	15 M @	450 (18)
	2.44 (8.0)	15 M @	150 (6)	15 M @	300 (12)	15 M @	450 (18)	15 M @	450 (18)	15 M @	150 (6)	15 M @	300 (12)	15 M @	300 (12)	15 M @	450 (18)
	2.74 (9.0)	15 M @	150 (6)	15 M @	150 (6)	15 M @	300 (12)	15 M @	450 (18)			15 M @	150 (6)	15 M @	300 (12)	15 M @	300 (12)
	3.05 (10.0)			15 M @	150 (6)	15 M @	300 (12)	15 M @	300 (12)					15 M @	150 (6)	15 M @	300 (12)
	3.35 (11.0)					15 M @	150 (6)	15 M @	300 (12)					15 M @	150 (6)	15 M @	150 (6)
	3.66 (12.0)					15 M @	150 (6)	15 M @	150 (6)					15 M @	150 (6)	15 M @	150 (6)
Horizontal Reinforcement	Block Height of 12" and 18"	10 M @	900 (36)	10 M @	900 (36)	10 M @	900 (36)	10 M @	900 (36)	10 M @	900 (36)	10 M @	900 (36)	10 M @	900 (36)	10 M @	900 (36)
	Block Height of 16"	10 M @	800 (32)	10 M @	800 (32)	10 M @	800 (32)	10 M @	800 (32)	10 M @	800 (32)	10 M @	800 (32)	10 M @	800 (32)	10 M @	800 (32)

NOTES

- For highlighted data, where the below grade wall meets all the requirements of NBC Part 9 for a solid concrete foundation wall and supports only wood frame construction above, a 20MPa unreinforced wall is adequate as per 2015 NBC table 9.15.4.2.A. Provide the reinforcing shown for walls supporting ICF walls above or with brick veneer supported with the brick ledge form.
- Below grade walls supporting "Drained Earth" in accordance with 2015 NBC 9.4.4.6 may be designed for an equivalent fluid pressure of 480 kg/m3.
- This table is to be used in conjunction with the "Design Limitations" and "Below Grade Reinforcement Placement" drawing.

Table B.1.2.– Below Grade Wall Distributed Reinforcement for Seismic Zone Classification, $S_a(0.2) \leq 0.25$ and Hourly Wind Pressure, $q_{1/50} \leq 1.05\text{kPa}$, for ICF Walls with 8" Tie Spacing

Wall Height m (ft)	Backfill Height m (ft)		Vertical Steel (Size and Spacing)																							
			Backfill Equivalent Fluid Density																							
			480 kg/m ³ (30 pcf)								720 kg/m ³ (45 pcf)															
		150 mm (6") Wall		200 mm (8") Wall		250 mm (10") Wall		300 mm (12") Wall		150 mm (6") Wall		200 mm (8") Wall		250 mm (10") Wall		300 mm (12") Wall										
2.44 (8.0)	1.22	(4.0)	10 M @	400	(16)	10 M @	600	(24)	10 M @	800	(32)	10 M @	800	(32)	10 M @	400	(16)	10 M @	600	(24)	10 M @	800	(32)	10 M @	800	(32)
	1.53	(5.0)	10 M @	400	(16)	10 M @	600	(24)	10 M @	800	(32)	10 M @	800	(32)	15 M @	600	(24)	10 M @	400	(16)	10 M @	800	(32)	10 M @	800	(32)
	1.83	(6.0)	15 M @	600	(24)	10 M @	400	(16)	10 M @	600	(24)	10 M @	800	(32)	15 M @	400	(16)	15 M @	600	(24)	10 M @	400	(16)	10 M @	800	(32)
	2.13	(7.0)	15 M @	400	(16)	15 M @	600	(24)	10 M @	400	(16)	10 M @	600	(24)	15 M @	400	(16)	15 M @	600	(24)	10 M @	400	(16)	10 M @	600	(24)
	2.44	(8.0)	15 M @	400	(16)	15 M @	400	(16)	10 M @	400	(16)	10 M @	400	(16)	15 M @	400	(16)	15 M @	400	(16)	15 M @	600	(24)	15 M @	800	(32)
2.74 (9.0)	1.22	(4.0)	15 M @	800	(32)	10 M @	600	(24)	10 M @	800	(32)	10 M @	800	(32)	15 M @	800	(32)	10 M @	600	(24)	10 M @	800	(32)	10 M @	800	(32)
	1.53	(5.0)	15 M @	800	(32)	10 M @	400	(16)	10 M @	800	(32)	10 M @	800	(32)	15 M @	600	(24)	10 M @	400	(16)	10 M @	600	(24)	10 M @	800	(32)
	1.83	(6.0)	15 M @	400	(16)	15 M @	800	(32)	10 M @	600	(24)	10 M @	800	(32)	15 M @	400	(16)	15 M @	600	(24)	10 M @	400	(16)	10 M @	600	(24)
	2.13	(7.0)	15 M @	400	(16)	15 M @	600	(24)	10 M @	400	(16)	10 M @	600	(24)	15 M @	400	(16)	15 M @	400	(16)	15 M @	600	(24)	15 M @	800	(32)
	2.44	(8.0)	15 M @	400	(16)	15 M @	400	(16)	15 M @	600	(24)	15 M @	800	(32)	15 M @	200	(8)	15 M @	400	(16)	15 M @	400	(16)	15 M @	600	(24)
2.74	(9.0)	15 M @	200	(8)	15 M @	400	(16)	15 M @	600	(24)	15 M @	600	(24)	15 M @	200	(8)	15 M @	400	(16)	15 M @	400	(16)	15 M @	600	(24)	
3.05 (10.0)	1.22	(4.0)	15 M @	800	(32)	10 M @	600	(24)	10 M @	800	(32)	10 M @	800	(32)	15 M @	800	(32)	10 M @	400	(16)	10 M @	800	(32)	10 M @	800	(32)
	1.53	(5.0)	15 M @	600	(24)	15 M @	800	(32)	10 M @	600	(24)	10 M @	800	(32)	15 M @	600	(24)	15 M @	800	(32)	10 M @	600	(24)	10 M @	800	(32)
	1.83	(6.0)	15 M @	400	(16)	15 M @	600	(24)	10 M @	400	(16)	10 M @	600	(24)	15 M @	400	(16)	15 M @	600	(24)	10 M @	400	(16)	10 M @	600	(24)
	2.13	(7.0)	15 M @	400	(16)	15 M @	400	(16)	10 M @	400	(16)	15 M @	800	(32)	15 M @	400	(16)	15 M @	400	(16)	15 M @	600	(24)	15 M @	800	(32)
	2.44	(8.0)	15 M @	400	(16)	15 M @	400	(16)	15 M @	600	(24)	15 M @	800	(32)	15 M @	200	(8)	15 M @	400	(16)	15 M @	400	(16)	15 M @	600	(24)
	2.74	(9.0)	15 M @	200	(8)	15 M @	400	(16)	15 M @	400	(16)	15 M @	600	(24)	15 M @	200	(8)	15 M @	400	(16)	15 M @	400	(16)	15 M @	400	(16)
	3.05	(10.0)	15 M @	200	(8)	15 M @	400	(16)	15 M @	400	(16)	15 M @	400	(16)	15 M @	200	(8)	15 M @	200	(8)	15 M @	400	(16)	15 M @	400	(16)
3.35 (11.0)	1.22	(4.0)	15 M @	800	(32)	10 M @	400	(16)	10 M @	800	(32)	10 M @	900	(36)	15 M @	600	(24)	10 M @	400	(16)	10 M @	600	(24)	10 M @	800	(32)
	1.53	(5.0)	15 M @	600	(24)	15 M @	800	(32)	10 M @	600	(24)	10 M @	900	(36)	15 M @	400	(16)	15 M @	800	(32)	10 M @	400	(16)	10 M @	800	(32)
	1.83	(6.0)	15 M @	400	(16)	15 M @	600	(24)	10 M @	400	(16)	10 M @	600	(24)	15 M @	400	(16)	15 M @	600	(24)	10 M @	400	(16)	10 M @	600	(24)
	2.13	(7.0)	15 M @	400	(16)	15 M @	400	(16)	15 M @	600	(24)	15 M @	800	(32)	15 M @	400	(16)	15 M @	400	(16)	15 M @	600	(24)	15 M @	800	(32)
	2.44	(8.0)	15 M @	200	(8)	15 M @	400	(16)	15 M @	400	(16)	15 M @	600	(24)	15 M @	200	(8)	15 M @	400	(16)	15 M @	400	(16)	15 M @	600	(24)
	2.74	(9.0)	15 M @	200	(8)	15 M @	400	(16)	15 M @	400	(16)	15 M @	600	(24)	15 M @	200	(8)	15 M @	300	(12)	15 M @	400	(16)	15 M @	400	(16)
	3.05	(10.0)	15 M @	200	(8)	15 M @	200	(8)	15 M @	400	(16)	15 M @	400	(16)				15 M @	200	(8)	15 M @	400	(16)	15 M @	400	(16)
3.35	(11.0)				15 M @	200	(8)	15 M @	400	(16)	15 M @	400	(16)				15 M @	200	(8)	15 M @	200	(8)	15 M @	400	(16)	
3.66 (12.0)	1.22	(4.0)	15 M @	600	(24)	10 M @	400	(16)	10 M @	800	(32)	10 M @	800	(32)	15 M @	600	(24)	15 M @	800	(32)	10 M @	600	(24)	10 M @	800	(32)
	1.53	(5.0)	15 M @	600	(24)	15 M @	800	(32)	10 M @	600	(24)	10 M @	800	(32)	15 M @	400	(16)	15 M @	600	(24)	10 M @	400	(16)	10 M @	600	(24)
	1.83	(6.0)	15 M @	400	(16)	15 M @	600	(24)	10 M @	400	(16)	10 M @	600	(24)	15 M @	400	(16)	15 M @	600	(24)	15 M @	800	(32)	15 M @	800	(32)
	2.13	(7.0)	15 M @	400	(16)	15 M @	400	(16)	15 M @	600	(24)	15 M @	800	(32)	15 M @	200	(8)	15 M @	400	(16)	15 M @	600	(24)	15 M @	600	(24)
	2.44	(8.0)	15 M @	200	(8)	15 M @	400	(16)	15 M @	400	(16)	15 M @	600	(24)	15 M @	200	(8)	15 M @	400	(16)	15 M @	400	(16)	15 M @	400	(16)
	2.74	(9.0)	15 M @	200	(8)	15 M @	200	(8)	15 M @	400	(16)	15 M @	400	(16)	15 M @	200	(8)	15 M @	200	(8)	15 M @	400	(16)	15 M @	400	(16)
	3.05	(10.0)	15 M @	200	(8)	15 M @	200	(8)	15 M @	400	(16)	15 M @	400	(16)				15 M @	200	(8)	15 M @	200	(8)	15 M @	400	(16)
	3.35	(11.0)				15 M @	200	(8)	15 M @	200	(8)	15 M @	400	(16)				15 M @	200	(8)	15 M @	200	(8)	15 M @	400	(16)
3.66	(12.0)				15 M @	200	(8)	15 M @	200	(8)	15 M @	400	(16)				15 M @	200	(8)	15 M @	200	(8)	15 M @	200	(8)	
Horizontal Reinforcement	Block Height of 12" and 18"		10 M @	900	(36)	10 M @	900	(36)	10 M @	900	(36)	10 M @	900	(36)	10 M @	900	(36)	10 M @	900	(36)	10 M @	900	(36)	10 M @	900	(36)
	Block Height of 16"		10 M @	800	(32)	10 M @	800	(32)	10 M @	800	(32)	10 M @	800	(32)	10 M @	800	(32)	10 M @	800	(32)	10 M @	800	(32)	10 M @	800	(32)

NOTES

- For highlighted data, where the below grade wall meets all the requirements of NBC Part 9 for a solid concrete foundation wall and supports only wood frame construction above, a 20MPa unreinforced wall is adequate as per 2015 NBC table 9.15.4.2.A. Provide the reinforcing shown for walls supporting ICF walls above or with brick veneer supported with the brick ledge form.
- Below grade walls supporting "Drained Earth" in accordance with 2015 NBC 9.4.4.6 may be designed for an equivalent fluid pressure of 480 kg/m³.
- This table is to be used in conjunction with the "Design Limitations" and "Below Grade Reinforcement Placement" drawing.

Table B.1.2. Continued – Below Grade Wall Distributed Reinforcement for Seismic Zone Classification, $S_a(0.2) \leq 0.25$ and Hourly Wind Pressure, $q_{1/50} \leq 1.05\text{kPa}$, for ICF Walls with 8” Tie Spacing

Wall Height m (ft)	Backfill Height m (ft)	Vertical Steel (Size and Spacing)															
		Backfill Equivalent Fluid Density															
		960 kg/m3 (60 pcf)								1200 kg/m3 (75 pcf)							
		150 mm (6") Wall		200 mm (8") Wall		250 mm (10") Wall		300 mm (12") Wall		150 mm (6") Wall		200 mm (8") Wall		250 mm (10") Wall		300 mm (12") Wall	
2.44 (8.0)	1.22 (4.0)	15 M @ 600 (24)	10 M @ 400 (16)	10 M @ 400 (16)	10 M @ 800 (32)	10 M @ 800 (32)	15 M @ 600 (24)	15 M @ 400 (16)	15 M @ 400 (16)	10 M @ 800 (32)	15 M @ 600 (24)	15 M @ 800 (32)	15 M @ 800 (32)	10 M @ 800 (32)	10 M @ 800 (32)	10 M @ 800 (32)	10 M @ 800 (32)
	1.53 (5.0)	15 M @ 600 (24)	10 M @ 400 (16)	10 M @ 400 (16)	10 M @ 800 (32)	10 M @ 800 (32)	15 M @ 400 (16)	15 M @ 800 (32)	15 M @ 800 (32)	15 M @ 400 (16)	15 M @ 800 (32)	15 M @ 800 (32)	15 M @ 800 (32)	10 M @ 800 (32)	10 M @ 800 (32)	10 M @ 800 (32)	10 M @ 800 (32)
	1.83 (6.0)	15 M @ 400 (16)	15 M @ 600 (24)	10 M @ 400 (16)	10 M @ 400 (16)	10 M @ 600 (24)	15 M @ 400 (16)	15 M @ 800 (32)	15 M @ 800 (32)	15 M @ 400 (16)	15 M @ 800 (32)	15 M @ 800 (32)	15 M @ 800 (32)	15 M @ 800 (32)	15 M @ 800 (32)	15 M @ 800 (32)	15 M @ 800 (32)
	2.13 (7.0)	15 M @ 400 (16)	15 M @ 400 (16)	15 M @ 400 (16)	15 M @ 600 (24)	15 M @ 800 (32)	15 M @ 200 (8)	15 M @ 400 (16)	15 M @ 600 (24)	15 M @ 200 (8)	15 M @ 400 (16)	15 M @ 600 (24)	15 M @ 600 (24)	15 M @ 600 (24)	15 M @ 600 (24)	15 M @ 600 (24)	15 M @ 600 (24)
	2.44 (8.0)	15 M @ 200 (8)	15 M @ 400 (16)	15 M @ 400 (16)	15 M @ 400 (16)	15 M @ 600 (24)	15 M @ 200 (8)	15 M @ 400 (16)	15 M @ 600 (24)	15 M @ 200 (8)	15 M @ 400 (16)	15 M @ 600 (24)	15 M @ 600 (24)	15 M @ 600 (24)	15 M @ 600 (24)	15 M @ 600 (24)	15 M @ 600 (24)
2.74 (9.0)	1.22 (4.0)	15 M @ 600 (24)	10 M @ 400 (16)	10 M @ 400 (16)	10 M @ 600 (24)	10 M @ 800 (32)	15 M @ 600 (24)	15 M @ 400 (16)	15 M @ 400 (16)	10 M @ 800 (32)	15 M @ 600 (24)	15 M @ 800 (32)	15 M @ 800 (32)	10 M @ 800 (32)	10 M @ 800 (32)	10 M @ 800 (32)	10 M @ 800 (32)
	1.53 (5.0)	15 M @ 400 (16)	15 M @ 600 (24)	10 M @ 400 (16)	10 M @ 400 (16)	10 M @ 600 (24)	15 M @ 400 (16)	15 M @ 800 (32)	15 M @ 800 (32)	15 M @ 400 (16)	15 M @ 800 (32)	15 M @ 800 (32)	15 M @ 800 (32)	10 M @ 800 (32)	10 M @ 800 (32)	10 M @ 800 (32)	10 M @ 800 (32)
	1.83 (6.0)	15 M @ 400 (16)	15 M @ 400 (16)	15 M @ 400 (16)	15 M @ 800 (32)	10 M @ 600 (24)	15 M @ 400 (16)	15 M @ 800 (32)	15 M @ 800 (32)	15 M @ 400 (16)	15 M @ 800 (32)	15 M @ 800 (32)	15 M @ 800 (32)	15 M @ 800 (32)	15 M @ 800 (32)	15 M @ 800 (32)	15 M @ 800 (32)
	2.13 (7.0)	15 M @ 400 (16)	15 M @ 400 (16)	15 M @ 400 (16)	15 M @ 600 (24)	15 M @ 800 (32)	15 M @ 200 (8)	15 M @ 400 (16)	15 M @ 600 (24)	15 M @ 200 (8)	15 M @ 400 (16)	15 M @ 600 (24)	15 M @ 600 (24)	15 M @ 600 (24)	15 M @ 600 (24)	15 M @ 600 (24)	15 M @ 600 (24)
	2.44 (8.0)	15 M @ 200 (8)	15 M @ 400 (16)	15 M @ 400 (16)	15 M @ 400 (16)	15 M @ 600 (24)	15 M @ 200 (8)	15 M @ 400 (16)	15 M @ 600 (24)	15 M @ 200 (8)	15 M @ 400 (16)	15 M @ 600 (24)	15 M @ 600 (24)	15 M @ 600 (24)	15 M @ 600 (24)	15 M @ 600 (24)	15 M @ 600 (24)
	2.74 (9.0)	15 M @ 200 (8)	15 M @ 400 (16)	15 M @ 400 (16)	15 M @ 400 (16)	15 M @ 400 (16)		15 M @ 200 (8)	15 M @ 400 (16)		15 M @ 200 (8)	15 M @ 400 (16)	15 M @ 400 (16)	15 M @ 400 (16)	15 M @ 400 (16)	15 M @ 400 (16)	15 M @ 400 (16)
3.05 (10.0)	1.22 (4.0)	15 M @ 600 (24)	10 M @ 400 (16)	10 M @ 400 (16)	10 M @ 600 (24)	10 M @ 800 (32)	15 M @ 600 (24)	15 M @ 400 (16)	15 M @ 400 (16)	10 M @ 800 (32)	15 M @ 600 (24)	15 M @ 800 (32)	15 M @ 800 (32)	10 M @ 800 (32)	10 M @ 800 (32)	10 M @ 800 (32)	10 M @ 800 (32)
	1.53 (5.0)	15 M @ 400 (16)	15 M @ 600 (24)	10 M @ 400 (16)	10 M @ 400 (16)	10 M @ 600 (24)	15 M @ 400 (16)	15 M @ 800 (32)	15 M @ 800 (32)	15 M @ 400 (16)	15 M @ 800 (32)	15 M @ 800 (32)	15 M @ 800 (32)	10 M @ 800 (32)	10 M @ 800 (32)	10 M @ 800 (32)	10 M @ 800 (32)
	1.83 (6.0)	15 M @ 400 (16)	15 M @ 400 (16)	15 M @ 400 (16)	15 M @ 800 (32)	15 M @ 800 (32)	15 M @ 400 (16)	15 M @ 800 (32)	15 M @ 800 (32)	15 M @ 400 (16)	15 M @ 800 (32)	15 M @ 800 (32)	15 M @ 800 (32)	15 M @ 800 (32)	15 M @ 800 (32)	15 M @ 800 (32)	15 M @ 800 (32)
	2.13 (7.0)	15 M @ 200 (8)	15 M @ 400 (16)	15 M @ 400 (16)	15 M @ 600 (24)	15 M @ 800 (32)	15 M @ 200 (8)	15 M @ 400 (16)	15 M @ 600 (24)	15 M @ 200 (8)	15 M @ 400 (16)	15 M @ 600 (24)	15 M @ 600 (24)	15 M @ 600 (24)	15 M @ 600 (24)	15 M @ 600 (24)	15 M @ 600 (24)
	2.44 (8.0)	15 M @ 200 (8)	15 M @ 400 (16)	15 M @ 400 (16)	15 M @ 400 (16)	15 M @ 600 (24)	15 M @ 200 (8)	15 M @ 400 (16)	15 M @ 600 (24)	15 M @ 200 (8)	15 M @ 400 (16)	15 M @ 600 (24)	15 M @ 600 (24)	15 M @ 600 (24)	15 M @ 600 (24)	15 M @ 600 (24)	15 M @ 600 (24)
	2.74 (9.0)	15 M @ 200 (8)	15 M @ 200 (8)	15 M @ 400 (16)	15 M @ 400 (16)	15 M @ 400 (16)		15 M @ 200 (8)	15 M @ 400 (16)		15 M @ 200 (8)	15 M @ 400 (16)	15 M @ 400 (16)	15 M @ 400 (16)	15 M @ 400 (16)	15 M @ 400 (16)	15 M @ 400 (16)
	3.05 (10.0)		15 M @ 200 (8)	15 M @ 400 (16)	15 M @ 400 (16)	15 M @ 400 (16)		15 M @ 200 (8)	15 M @ 400 (16)		15 M @ 200 (8)	15 M @ 400 (16)	15 M @ 400 (16)	15 M @ 400 (16)	15 M @ 400 (16)	15 M @ 400 (16)	15 M @ 400 (16)
3.35 (11.0)	1.22 (4.0)	15 M @ 600 (24)	15 M @ 600 (24)	10 M @ 600 (24)	10 M @ 600 (24)	10 M @ 800 (32)	15 M @ 600 (24)	15 M @ 400 (16)	15 M @ 400 (16)	10 M @ 800 (32)	15 M @ 600 (24)	15 M @ 800 (32)	15 M @ 800 (32)	10 M @ 800 (32)	10 M @ 800 (32)	10 M @ 800 (32)	10 M @ 800 (32)
	1.53 (5.0)	15 M @ 400 (16)	15 M @ 600 (24)	10 M @ 400 (16)	10 M @ 400 (16)	10 M @ 600 (24)	15 M @ 400 (16)	15 M @ 800 (32)	15 M @ 800 (32)	15 M @ 400 (16)	15 M @ 800 (32)	15 M @ 800 (32)	15 M @ 800 (32)	10 M @ 800 (32)	10 M @ 800 (32)	10 M @ 800 (32)	10 M @ 800 (32)
	1.83 (6.0)	15 M @ 400 (16)	15 M @ 400 (16)	15 M @ 400 (16)	15 M @ 600 (24)	15 M @ 800 (32)	15 M @ 400 (16)	15 M @ 800 (32)	15 M @ 800 (32)	15 M @ 400 (16)	15 M @ 800 (32)	15 M @ 800 (32)	15 M @ 800 (32)	15 M @ 800 (32)	15 M @ 800 (32)	15 M @ 800 (32)	15 M @ 800 (32)
	2.13 (7.0)	15 M @ 200 (8)	15 M @ 400 (16)	15 M @ 400 (16)	15 M @ 400 (16)	15 M @ 600 (24)	15 M @ 200 (8)	15 M @ 400 (16)	15 M @ 600 (24)	15 M @ 200 (8)	15 M @ 400 (16)	15 M @ 600 (24)	15 M @ 600 (24)	15 M @ 600 (24)	15 M @ 600 (24)	15 M @ 600 (24)	15 M @ 600 (24)
	2.44 (8.0)	15 M @ 200 (8)	15 M @ 200 (8)	15 M @ 400 (16)	15 M @ 400 (16)	15 M @ 600 (24)	15 M @ 200 (8)	15 M @ 400 (16)	15 M @ 600 (24)	15 M @ 200 (8)	15 M @ 400 (16)	15 M @ 600 (24)	15 M @ 600 (24)	15 M @ 600 (24)	15 M @ 600 (24)	15 M @ 600 (24)	15 M @ 600 (24)
	2.74 (9.0)		15 M @ 200 (8)	15 M @ 400 (16)	15 M @ 400 (16)	15 M @ 400 (16)		15 M @ 200 (8)	15 M @ 400 (16)		15 M @ 200 (8)	15 M @ 400 (16)	15 M @ 400 (16)	15 M @ 400 (16)	15 M @ 400 (16)	15 M @ 400 (16)	15 M @ 400 (16)
	3.05 (10.0)		15 M @ 200 (8)	15 M @ 200 (8)	15 M @ 200 (8)	15 M @ 400 (16)		15 M @ 200 (8)	15 M @ 400 (16)		15 M @ 200 (8)	15 M @ 400 (16)	15 M @ 400 (16)	15 M @ 400 (16)	15 M @ 400 (16)	15 M @ 400 (16)	15 M @ 400 (16)
	3.35 (11.0)		15 M @ 200 (8)	15 M @ 200 (8)	15 M @ 200 (8)	15 M @ 200 (8)		15 M @ 200 (8)	15 M @ 400 (16)		15 M @ 200 (8)	15 M @ 400 (16)	15 M @ 400 (16)	15 M @ 400 (16)	15 M @ 400 (16)	15 M @ 400 (16)	15 M @ 400 (16)
3.66 (12.0)	1.22 (4.0)	15 M @ 600 (24)	15 M @ 600 (24)	10 M @ 600 (24)	10 M @ 600 (24)	10 M @ 800 (32)	15 M @ 600 (24)	15 M @ 400 (16)	15 M @ 400 (16)	10 M @ 800 (32)	15 M @ 600 (24)	15 M @ 800 (32)	15 M @ 800 (32)	10 M @ 800 (32)	10 M @ 800 (32)	10 M @ 800 (32)	10 M @ 800 (32)
	1.53 (5.0)	15 M @ 400 (16)	15 M @ 400 (16)	15 M @ 400 (16)	15 M @ 600 (24)	15 M @ 800 (32)	15 M @ 400 (16)	15 M @ 800 (32)	15 M @ 800 (32)	15 M @ 400 (16)	15 M @ 800 (32)	15 M @ 800 (32)	15 M @ 800 (32)	15 M @ 800 (32)	15 M @ 800 (32)	15 M @ 800 (32)	15 M @ 800 (32)
	1.83 (6.0)	15 M @ 400 (16)	15 M @ 400 (16)	15 M @ 400 (16)	15 M @ 600 (24)	15 M @ 800 (32)	15 M @ 400 (16)	15 M @ 800 (32)	15 M @ 800 (32)	15 M @ 400 (16)	15 M @ 800 (32)	15 M @ 800 (32)	15 M @ 800 (32)	15 M @ 800 (32)	15 M @ 800 (32)	15 M @ 800 (32)	15 M @ 800 (32)
	2.13 (7.0)	15 M @ 200 (8)	15 M @ 400 (16)	15 M @ 400 (16)	15 M @ 400 (16)	15 M @ 600 (24)	15 M @ 200 (8)	15 M @ 400 (16)	15 M @ 600 (24)	15 M @ 200 (8)	15 M @ 400 (16)	15 M @ 600 (24)	15 M @ 600 (24)	15 M @ 600 (24)	15 M @ 600 (24)	15 M @ 600 (24)	15 M @ 600 (24)
	2.44 (8.0)	15 M @ 200 (8)	15 M @ 200 (8)	15 M @ 400 (16)	15 M @ 400 (16)	15 M @ 600 (24)	15 M @ 200 (8)	15 M @ 400 (16)	15 M @ 600 (24)	15 M @ 200 (8)	15 M @ 400 (16)	15 M @ 600 (24)	15 M @ 600 (24)	15 M @ 600 (24)	15 M @ 600 (24)	15 M @ 600 (24)	15 M @ 600 (24)
	2.74 (9.0)		15 M @ 200 (8)	15 M @ 200 (8)	15 M @ 200 (8)	15 M @ 400 (16)		15 M @ 200 (8)	15 M @ 400 (16)		15 M @ 200 (8)	15 M @ 400 (16)	15 M @ 400 (16)	15 M @ 400 (16)	15 M @ 400 (16)	15 M @ 400 (16)	15 M @ 400 (16)
	3.05 (10.0)		15 M @ 200 (8)	15 M @ 200 (8)	15 M @ 200 (8)	15 M @ 400 (16)		15 M @ 200 (8)	15 M @ 400 (16)		15 M @ 200 (8)	15 M @ 400 (16)	15 M @ 400 (16)	15 M @ 400 (16)	15 M @ 400 (16)	15 M @ 400 (16)	15 M @ 400 (16)
	3.35 (11.0)			15 M @ 200 (8)	15 M @ 200 (8)	15 M @ 200 (8)		15 M @ 200 (8)	15 M @ 400 (16)		15 M @ 200 (8)	15 M @ 400 (16)	15 M @ 400 (16)	15 M @ 400 (16)	15 M @ 400 (16)	15 M @ 400 (16)	15 M @ 400 (16)
	3.66 (12.0)			15 M @ 200 (8)	15 M @ 200 (8)	15 M @ 200 (8)		15 M @ 200 (8)	15 M @ 400 (16)		15 M @ 200 (8)	15 M @ 400 (16)	15 M @ 400 (16)	15 M @ 400 (16)	15 M @ 400 (16)	15 M @ 400 (16)	15 M @ 400 (16)
Horizontal Reinforcement	Block Height of 12" and 18"	10 M @ 900 (36)	10 M @ 900 (36)	10 M @ 900 (36)	10 M @ 900 (36)	10 M @ 900 (36)	10 M @ 900 (36)	10 M @ 900 (36)	10 M @ 900 (36)	10 M @ 900 (36)	10 M @ 900 (36)	10 M @ 900 (36)	10 M @ 900 (36)	10 M @ 900 (36)	10 M @ 900 (36)	10 M @ 900 (36)	10 M @ 900 (36)
	Block Height of 16"	10 M @ 800 (32)	10 M @ 800 (32)	10 M @ 800 (32)	10 M @ 800 (32)	10 M @ 800 (32)	10 M @ 800 (32)	10 M @ 800 (32)	10 M @ 800 (32)	10 M @ 800 (32)	10 M @ 800 (32)	10 M @ 800 (32)	10 M @ 800 (32)	10 M @ 800 (32)	10 M @ 800 (32)	10 M @ 800 (32)	10 M @ 800 (32)

NOTES

- For highlighted data, where the below grade wall meets all the requirements of NBC Part 9 for a solid concrete foundation wall and supports only wood frame construction above, a 20MPa unreinforced wall is adequate as per 2015 NBC table 9.15.4.2.A. Provide the reinforcing shown for walls supporting ICF walls above or with brick veneer supported with the brick ledge form.
- Below grade walls supporting "Drained Earth" in accordance with 2015 NBC 9.4.4.6 may be designed for an equivalent fluid pressure of 480 kg/m3.
- This table is to be used in conjunction with the "Design Limitations" and "Below Grade Reinforcement Placement" drawing.

Table B.2.1. – Below Grade Wall Distributed Reinforcement for Seismic Zone Classification, $0.25 < Sa(0.2) \leq 0.70$ and Hourly Wind Pressure, $q_{1/50} \leq 1.05\text{kPa}$, for ICF Walls with 6" Tie Spacing

Wall Height m (ft)	Backfill Height m (ft)		Vertical Steel (Size and Spacing)																							
			Backfill Equivalent Fluid Density																							
			480 kg/m ³ (30 pcf)								720 kg/m ³ (45 pcf)															
		150 mm (6") Wall		200 mm (8") Wall		250 mm (10") Wall		300 mm (12") Wall		150 mm (6") Wall		200 mm (8") Wall		250 mm (10") Wall		300 mm (12") Wall										
2.44 (8.0)	1.22	(4.0)	10 M @	450	(18)	10 M @	600	(24)	10 M @	450	(18)	10 M @	450	(18)	15 M @	450	(18)	10 M @	450	(18)	10 M @	450	(18)	10 M @	450	(18)
	1.53	(5.0)	15 M @	600	(24)	15 M @	600	(24)	10 M @	450	(18)	10 M @	450	(18)	15 M @	450	(18)	15 M @	600	(24)	10 M @	450	(18)	10 M @	450	(18)
	1.83	(6.0)	15 M @	450	(18)	15 M @	600	(24)	15 M @	600	(24)	15 M @	600	(24)	15 M @	450	(18)	15 M @	450	(18)	15 M @	600	(24)	15 M @	600	(24)
	2.13	(7.0)	15 M @	300	(12)	15 M @	450	(18)	15 M @	600	(24)	15 M @	600	(24)	15 M @	300	(12)	15 M @	450	(18)	15 M @	450	(18)	15 M @	600	(24)
	2.44	(8.0)	15 M @	300	(12)	15 M @	450	(18)	15 M @	600	(24)	15 M @	600	(24)	15 M @	150	(6)	15 M @	450	(18)	15 M @	450	(18)	15 M @	600	(24)
2.74 (9.0)	1.22	(4.0)	15 M @	600	(24)	10 M @	450	(18)	10 M @	450	(18)	10 M @	450	(18)	15 M @	600	(24)	10 M @	450	(18)	10 M @	450	(18)	10 M @	450	(18)
	1.53	(5.0)	15 M @	450	(18)	15 M @	600	(24)	10 M @	450	(18)	10 M @	450	(18)	15 M @	450	(18)	15 M @	600	(24)	15 M @	600	(24)	10 M @	450	(18)
	1.83	(6.0)	15 M @	450	(18)	15 M @	600	(24)	15 M @	600	(24)	15 M @	600	(24)	15 M @	300	(12)	15 M @	450	(18)	15 M @	600	(24)	15 M @	600	(24)
	2.13	(7.0)	15 M @	300	(12)	15 M @	450	(18)	15 M @	600	(24)	15 M @	600	(24)	15 M @	300	(12)	15 M @	450	(18)	15 M @	450	(18)	15 M @	600	(24)
	2.44	(8.0)	15 M @	150	(6)	15 M @	300	(12)	15 M @	450	(18)	15 M @	600	(24)	15 M @	150	(6)	15 M @	300	(12)	15 M @	450	(18)	15 M @	450	(18)
3.05 (10.0)	1.22	(4.0)	15 M @	600	(24)	10 M @	450	(18)	10 M @	450	(18)	10 M @	450	(18)	15 M @	600	(24)	10 M @	450	(18)	10 M @	450	(18)	10 M @	450	(18)
	1.53	(5.0)	15 M @	450	(18)	15 M @	600	(24)	10 M @	450	(18)	10 M @	450	(18)	15 M @	450	(18)	15 M @	600	(24)	10 M @	450	(18)	10 M @	450	(18)
	1.83	(6.0)	15 M @	300	(12)	15 M @	450	(18)	15 M @	600	(24)	15 M @	600	(24)	15 M @	300	(12)	15 M @	450	(18)	15 M @	600	(24)	15 M @	600	(24)
	2.13	(7.0)	15 M @	300	(12)	15 M @	450	(18)	15 M @	450	(18)	15 M @	600	(24)	15 M @	150	(6)	15 M @	300	(12)	15 M @	450	(18)	15 M @	600	(24)
	2.44	(8.0)	15 M @	150	(6)	15 M @	300	(12)	15 M @	450	(18)	15 M @	450	(18)	15 M @	150	(6)	15 M @	300	(12)	15 M @	450	(18)	15 M @	450	(18)
	2.74	(9.0)	15 M @	150	(6)	15 M @	300	(12)	15 M @	300	(12)	15 M @	450	(18)	15 M @	150	(6)	15 M @	150	(6)	15 M @	300	(12)	15 M @	300	(12)
	3.05	(10.0)	15 M @	150	(6)				15 M @	300	(12)	15 M @	300	(12)				15 M @	150	(6)	15 M @	300	(12)	15 M @	300	(12)
3.35 (11.0)	1.22	(4.0)	15 M @	600	(24)	10 M @	450	(18)	10 M @	450	(18)	10 M @	450	(18)	15 M @	600	(24)	10 M @	450	(18)	10 M @	450	(18)	10 M @	450	(18)
	1.53	(5.0)	15 M @	450	(18)	15 M @	600	(24)	10 M @	450	(18)	10 M @	450	(18)	15 M @	450	(18)	15 M @	600	(24)	10 M @	450	(18)	10 M @	450	(18)
	1.83	(6.0)	15 M @	300	(12)	15 M @	450	(18)	15 M @	600	(24)	15 M @	600	(24)	15 M @	300	(12)	15 M @	450	(18)	15 M @	600	(24)	15 M @	600	(24)
	2.13	(7.0)	15 M @	150	(6)	15 M @	450	(18)	15 M @	450	(18)	15 M @	600	(24)	15 M @	150	(6)	15 M @	300	(12)	15 M @	450	(18)	15 M @	450	(18)
	2.44	(8.0)	15 M @	150	(6)	15 M @	300	(12)	15 M @	450	(18)	15 M @	450	(18)	15 M @	150	(6)	15 M @	300	(12)	15 M @	300	(12)	15 M @	450	(18)
	2.74	(9.0)	15 M @	150	(6)	15 M @	150	(6)	15 M @	300	(12)	15 M @	300	(12)				15 M @	150	(6)	15 M @	300	(12)	15 M @	300	(12)
	3.05	(10.0)				15 M @	150	(6)	15 M @	300	(12)	15 M @	300	(12)				15 M @	150	(6)	15 M @	150	(6)	15 M @	300	(12)
3.66 (12.0)	1.22	(4.0)	15 M @	600	(24)	10 M @	450	(18)	10 M @	450	(18)	10 M @	450	(18)	15 M @	600	(24)	15 M @	600	(24)	10 M @	450	(18)	10 M @	450	(18)
	1.53	(5.0)	15 M @	450	(18)	15 M @	600	(24)	10 M @	450	(18)	10 M @	450	(18)	15 M @	450	(18)	15 M @	600	(24)	15 M @	600	(24)	10 M @	450	(18)
	1.83	(6.0)	15 M @	300	(12)	15 M @	450	(18)	15 M @	600	(24)	15 M @	600	(24)	15 M @	300	(12)	15 M @	450	(18)	15 M @	450	(18)	15 M @	600	(24)
	2.13	(7.0)	15 M @	150	(6)	15 M @	300	(12)	15 M @	450	(18)	15 M @	600	(24)	15 M @	150	(6)	15 M @	300	(12)	15 M @	450	(18)	15 M @	450	(18)
	2.44	(8.0)	15 M @	150	(6)	15 M @	300	(12)	15 M @	300	(12)	15 M @	450	(18)	15 M @	150	(6)	15 M @	150	(6)	15 M @	300	(12)	15 M @	450	(18)
	2.74	(9.0)				15 M @	150	(6)	15 M @	300	(12)	15 M @	300	(12)				15 M @	150	(6)	15 M @	300	(12)	15 M @	300	(12)
	3.05	(10.0)				15 M @	150	(6)	15 M @	150	(6)	15 M @	300	(12)				15 M @	150	(6)	15 M @	150	(6)	15 M @	300	(12)
	3.35	(11.0)				15 M @	150	(6)	15 M @	150	(6)	15 M @	300	(12)				15 M @	150	(6)	15 M @	150	(6)	15 M @	150	(6)
	3.66	(12.0)							15 M @	150	(6)	15 M @	150	(6)				15 M @	150	(6)	15 M @	150	(6)	15 M @	150	(6)
Horizontal Reinforcement	Block Height of 12" and 18"		15 M @	450	(18)	15 M @	450	(18)	15 M @	450	(18)	15 M @	450	(18)	15 M @	450	(18)	15 M @	450	(18)	15 M @	450	(18)	15 M @	450	(18)
	Block Height of 16"		15 M @	400	(16)	15 M @	400	(16)	15 M @	400	(16)	15 M @	400	(16)	15 M @	400	(16)	15 M @	400	(16)	15 M @	400	(16)	15 M @	400	(16)

NOTES

- For highlighted data, where the below grade wall meets all the requirements of NBC Part 9 for a solid concrete foundation wall and supports only wood frame construction above, a 20MPa unreinforced wall is adequate as per 2015 NBC table 9.15.4.2.A. Provide the reinforcing shown for walls supporting ICF walls above or with brick veneer supported with the brick ledge form.
- Below grade walls supporting "Drained Earth" in accordance with 2015 NBC 9.4.4.6 may be designed for an equivalent fluid pressure of 480 kg/m³.
- This table is to be used in conjunction with the "Design Limitations" and "Below Grade Reinforcement Placement" drawing.
- Alternating horizontal bar spacing of 12" o.c. and 24" o.c. may be used to achieve an average spacing of 18" o.c. where 18" o.c. spacing is specified for horizontal bars, as shown in Detail A.3.

Table B.2.1. Continued – Below Grade Wall Distributed Reinforcement for Seismic Zone Classification, $0.25 < S_a(0.2) \leq 0.70$ and Hourly Wind Pressure, $q_{1/50} \leq 1.05\text{kPa}$, for ICF Walls with 6" Tie Spacing

Wall Height m (ft)	Backfill Height m (ft)		Vertical Steel (Size and Spacing)																										
			Backfill Equivalent Fluid Density																										
			960 kg/m ³ (60 pcf)								1200 kg/m ³ (75 pcf)																		
		150 mm (6") Wall			200 mm (8") Wall			250 mm (10") Wall			300 mm (12") Wall			150 mm (6") Wall			200 mm (8") Wall			250 mm (10") Wall			300 mm (12") Wall						
2.44 (8.0)	1.22	(4.0)	15 M @	450	(18)	10 M @	450	(18)	10 M @	450	(18)	10 M @	450	(18)	15 M @	450	(18)	10 M @	450	(18)	10 M @	450	(18)	10 M @	450	(18)			
	1.53	(5.0)	15 M @	450	(18)	15 M @	600	(24)	10 M @	450	(18)	10 M @	450	(18)	15 M @	450	(18)	15 M @	600	(24)	10 M @	450	(18)	10 M @	450	(18)			
	1.83	(6.0)	15 M @	300	(12)	15 M @	450	(18)	15 M @	600	(24)	10 M @	450	(18)	15 M @	300	(12)	15 M @	450	(18)	15 M @	600	(24)	15 M @	600	(24)	15 M @	600	(24)
	2.13	(7.0)	15 M @	300	(12)	15 M @	450	(18)	15 M @	450	(18)	15 M @	600	(24)	15 M @	150	(6)	15 M @	300	(12)	15 M @	450	(18)	15 M @	600	(24)	15 M @	600	(24)
	2.44	(8.0)	15 M @	150	(6)	15 M @	300	(12)	15 M @	450	(18)	15 M @	600	(24)	15 M @	150	(6)	15 M @	300	(12)	15 M @	450	(18)	15 M @	450	(18)	15 M @	450	(18)
2.74 (9.0)	1.22	(4.0)	15 M @	600	(24)	15 M @	600	(24)	10 M @	450	(18)	10 M @	450	(18)	15 M @	600	(24)	15 M @	600	(24)	10 M @	450	(18)	10 M @	450	(18)	10 M @	450	(18)
	1.53	(5.0)	15 M @	450	(18)	15 M @	600	(24)	10 M @	450	(18)	10 M @	450	(18)	15 M @	450	(18)	15 M @	600	(24)	10 M @	450	(18)	10 M @	450	(18)	10 M @	450	(18)
	1.83	(6.0)	15 M @	300	(12)	15 M @	450	(18)	15 M @	600	(24)	15 M @	600	(24)	15 M @	300	(12)	15 M @	450	(18)	15 M @	450	(18)	15 M @	600	(24)	15 M @	600	(24)
	2.13	(7.0)	15 M @	150	(6)	15 M @	300	(12)	15 M @	450	(18)	15 M @	600	(24)	15 M @	150	(6)	15 M @	300	(12)	15 M @	450	(18)	15 M @	450	(18)	15 M @	600	(24)
	2.44	(8.0)	15 M @	150	(6)	15 M @	300	(12)	15 M @	450	(18)	15 M @	450	(18)	15 M @	150	(6)	15 M @	300	(12)	15 M @	300	(12)	15 M @	300	(12)	15 M @	300	(12)
3.05 (10.0)	1.22	(4.0)	15 M @	600	(24)	15 M @	600	(24)	10 M @	450	(18)	10 M @	450	(18)	15 M @	600	(24)	15 M @	600	(24)	10 M @	450	(18)	10 M @	450	(18)	10 M @	450	(18)
	1.53	(5.0)	15 M @	450	(18)	15 M @	600	(24)	10 M @	450	(18)	10 M @	450	(18)	15 M @	450	(18)	15 M @	600	(24)	15 M @	600	(24)	10 M @	450	(18)	10 M @	450	(18)
	1.83	(6.0)	15 M @	300	(12)	15 M @	450	(18)	15 M @	600	(24)	15 M @	600	(24)	15 M @	300	(12)	15 M @	450	(18)	15 M @	450	(18)	15 M @	600	(24)	15 M @	600	(24)
	2.13	(7.0)	15 M @	150	(6)	15 M @	300	(12)	15 M @	450	(18)	15 M @	450	(18)	15 M @	150	(6)	15 M @	300	(12)	15 M @	450	(18)	15 M @	450	(18)	15 M @	600	(24)
	2.44	(8.0)	15 M @	150	(6)	15 M @	300	(12)	15 M @	300	(12)	15 M @	300	(12)	15 M @	150	(6)	15 M @	150	(6)	15 M @	300	(12)	15 M @	300	(12)	15 M @	300	(12)
	2.74	(9.0)				15 M @	150	(6)	15 M @	300	(12)	15 M @	300	(12)				15 M @	150	(6)	15 M @	300	(12)	15 M @	300	(12)	15 M @	300	(12)
	3.05	(10.0)				15 M @	150	(6)	15 M @	150	(6)	15 M @	300	(12)				15 M @	150	(6)	15 M @	150	(6)	15 M @	300	(12)	15 M @	300	(12)
3.35 (11.0)	1.22	(4.0)	15 M @	600	(24)	15 M @	600	(24)	10 M @	450	(18)	10 M @	450	(18)	15 M @	600	(24)	15 M @	600	(24)	10 M @	450	(18)	10 M @	450	(18)	10 M @	450	(18)
	1.53	(5.0)	15 M @	450	(18)	15 M @	600	(24)	10 M @	450	(18)	10 M @	450	(18)	15 M @	450	(18)	15 M @	600	(24)	15 M @	600	(24)	10 M @	450	(18)	10 M @	450	(18)
	1.83	(6.0)	15 M @	300	(12)	15 M @	450	(18)	15 M @	450	(18)	15 M @	600	(24)	15 M @	150	(6)	15 M @	450	(18)	15 M @	450	(18)	15 M @	600	(24)	15 M @	600	(24)
	2.13	(7.0)	15 M @	150	(6)	15 M @	300	(12)	15 M @	450	(18)	15 M @	450	(18)	15 M @	150	(6)	15 M @	300	(12)	15 M @	450	(18)	15 M @	450	(18)	15 M @	600	(24)
	2.44	(8.0)	15 M @	150	(6)	15 M @	150	(6)	15 M @	300	(12)	15 M @	300	(12)				15 M @	150	(6)	15 M @	300	(12)	15 M @	300	(12)	15 M @	300	(12)
	2.74	(9.0)				15 M @	150	(6)	15 M @	300	(12)	15 M @	300	(12)				15 M @	150	(6)	15 M @	150	(6)	15 M @	300	(12)	15 M @	300	(12)
	3.05	(10.0)				15 M @	150	(6)	15 M @	150	(6)	15 M @	300	(12)				15 M @	150	(6)	15 M @	150	(6)	15 M @	300	(12)	15 M @	300	(12)
3.66 (12.0)	1.22	(4.0)	15 M @	600	(24)	15 M @	600	(24)	10 M @	450	(18)	10 M @	450	(18)	15 M @	450	(18)	15 M @	600	(24)	10 M @	450	(18)	10 M @	450	(18)	10 M @	450	(18)
	1.53	(5.0)	15 M @	450	(18)	15 M @	600	(24)	15 M @	600	(24)	10 M @	450	(18)	15 M @	450	(18)	15 M @	450	(18)	15 M @	600	(24)	10 M @	450	(18)	10 M @	450	(18)
	1.83	(6.0)	15 M @	150	(6)	15 M @	450	(18)	15 M @	450	(18)	15 M @	600	(24)	15 M @	150	(6)	15 M @	300	(12)	15 M @	450	(18)	15 M @	600	(24)	15 M @	600	(24)
	2.13	(7.0)	15 M @	150	(6)	15 M @	300	(12)	15 M @	450	(18)	15 M @	450	(18)	15 M @	150	(6)	15 M @	300	(12)	15 M @	300	(12)	15 M @	450	(18)	15 M @	600	(24)
	2.44	(8.0)				15 M @	150	(6)	15 M @	300	(12)	15 M @	300	(12)				15 M @	150	(6)	15 M @	300	(12)	15 M @	300	(12)	15 M @	300	(12)
	2.74	(9.0)				15 M @	150	(6)	15 M @	150	(6)	15 M @	300	(12)				15 M @	150	(6)	15 M @	150	(6)	15 M @	300	(12)	15 M @	300	(12)
	3.05	(10.0)							15 M @	150	(6)	15 M @	150	(6)							15 M @	150	(6)	15 M @	150	(6)	15 M @	150	(6)
	3.35	(11.0)							15 M @	150	(6)	15 M @	150	(6)							15 M @	150	(6)	15 M @	150	(6)	15 M @	150	(6)
	3.66	(12.0)							15 M @	150	(6)	15 M @	150	(6)												15 M @	150	(6)	
Horizontal Reinforcement	Block Height of 12" and 18"		15 M @	450	(18)	15 M @	450	(18)	15 M @	450	(18)	15 M @	450	(18)	15 M @	450	(18)	15 M @	450	(18)	15 M @	450	(18)	15 M @	450	(18)	15 M @	450	(18)
	Block Height of 16"		15 M @	400	(16)	15 M @	400	(16)	15 M @	400	(16)	15 M @	400	(16)	15 M @	400	(16)	15 M @	400	(16)	15 M @	400	(16)	15 M @	400	(16)	15 M @	400	(16)

NOTES

- For highlighted data, where the below grade wall meets all the requirements of NBC Part 9 for a solid concrete foundation wall and supports only wood frame construction above, a 20MPa unreinforced wall is adequate as per 2015 NBC table 9.15.4.2.A. Provide the reinforcing shown for walls supporting ICF walls above or with brick veneer supported with the brick ledge form.
- Below grade walls supporting "Drained Earth" in accordance with 2015 NBC 9.4.4.6 may be designed for an equivalent fluid pressure of 480 kg/m³.
- This table is to be used in conjunction with the "Design Limitations" and "Below Grade Reinforcement Placement" drawing.
- Alternating horizontal bar spacing of 12" o.c. and 24" o.c. may be used to achieve an average spacing of 18" o.c. where 18" o.c. spacing is specified for horizontal bars, as shown in Detail A.3.

Table B.2.2. – Below Grade Wall Distributed Reinforcement for Seismic Zone Classification, $0.25 < Sa(0.2) \leq 0.70$ and Hourly Wind Pressure, $q_{1/50} \leq 1.05\text{kPa}$, for ICF Walls with 8" Tie Spacing

Wall Height m (ft)	Backfill Height m (ft)		Vertical Steel (Size and Spacing)																													
			Backfill Equivalent Fluid Density																													
			480 kg/m3 (30 pcf)								720 kg/m3 (45 pcf)																					
		150 mm (6") Wall		200 mm (8") Wall		250 mm (10") Wall		300 mm (12") Wall		150 mm (6") Wall		200 mm (8") Wall		250 mm (10") Wall		300 mm (12") Wall																
2.44 (8.0)	1.22	(4.0)	10 M @	400	(16)	10 M @	600	(24)	10 M @	400	(16)	10 M @	400	(16)	15 M @	400	(16)	10 M @	400	(16)	10 M @	400	(16)	10 M @	400	(16)	10 M @	400	(16)			
	1.53	(5.0)	15 M @	400	(16)	15 M @	600	(24)	10 M @	400	(16)	10 M @	400	(16)	15 M @	400	(16)	15 M @	600	(24)	10 M @	400	(16)	10 M @	400	(16)	10 M @	400	(16)			
	1.83	(6.0)	15 M @	400	(16)	15 M @	600	(24)	15 M @	600	(24)	15 M @	600	(24)	15 M @	400	(16)	15 M @	400	(16)	15 M @	600	(24)	15 M @	600	(24)	15 M @	600	(24)	15 M @	600	(24)
	2.13	(7.0)	15 M @	400	(16)	15 M @	400	(16)	15 M @	600	(24)	15 M @	600	(24)	15 M @	200	(8)	15 M @	400	(16)	15 M @	400	(16)	15 M @	600	(24)	15 M @	600	(24)	15 M @	600	(24)
	2.44	(8.0)	15 M @	200	(8)	15 M @	400	(16)	15 M @	400	(16)	15 M @	600	(24)	15 M @	200	(8)	15 M @	400	(16)	15 M @	400	(16)	15 M @	600	(24)	15 M @	600	(24)	15 M @	600	(24)
2.74 (9.0)	1.22	(4.0)	15 M @	600	(24)	10 M @	400	(16)	10 M @	400	(16)	10 M @	400	(16)	15 M @	600	(24)	10 M @	400	(16)	10 M @	400	(16)	10 M @	400	(16)	10 M @	400	(16)			
	1.53	(5.0)	15 M @	400	(16)	15 M @	600	(24)	10 M @	400	(16)	10 M @	400	(16)	15 M @	400	(16)	15 M @	600	(24)	15 M @	600	(24)	10 M @	400	(16)	10 M @	400	(16)			
	1.83	(6.0)	15 M @	400	(16)	15 M @	400	(16)	15 M @	600	(24)	15 M @	600	(24)	15 M @	400	(16)	15 M @	400	(16)	15 M @	600	(24)	15 M @	600	(24)	15 M @	600	(24)	15 M @	600	(24)
	2.13	(7.0)	15 M @	200	(8)	15 M @	400	(16)	15 M @	400	(16)	15 M @	600	(24)	15 M @	200	(8)	15 M @	400	(16)	15 M @	400	(16)	15 M @	600	(24)	15 M @	600	(24)	15 M @	600	(24)
	2.44	(8.0)	15 M @	200	(8)	15 M @	400	(16)	15 M @	400	(16)	15 M @	600	(24)	15 M @	200	(8)	15 M @	400	(16)	15 M @	400	(16)	15 M @	600	(24)	15 M @	600	(24)	15 M @	600	(24)
2.74	(9.0)	15 M @	200	(8)	15 M @	200	(8)	15 M @	400	(16)	15 M @	400	(16)				15 M @	200	(8)	15 M @	400	(16)	15 M @	400	(16)	15 M @	400	(16)	15 M @	400	(16)	
3.05 (10.0)	1.22	(4.0)	15 M @	600	(24)	10 M @	400	(16)	10 M @	400	(16)	10 M @	400	(16)	15 M @	600	(24)	10 M @	400	(16)	10 M @	400	(16)	10 M @	400	(16)	10 M @	400	(16)			
	1.53	(5.0)	15 M @	400	(16)	15 M @	600	(24)	10 M @	400	(16)	10 M @	400	(16)	15 M @	400	(16)	15 M @	600	(24)	10 M @	400	(16)	10 M @	400	(16)	10 M @	400	(16)			
	1.83	(6.0)	15 M @	400	(16)	15 M @	400	(16)	15 M @	600	(24)	15 M @	600	(24)	15 M @	200	(8)	15 M @	400	(16)	15 M @	600	(24)	15 M @	600	(24)	15 M @	600	(24)	15 M @	600	(24)
	2.13	(7.0)	15 M @	200	(8)	15 M @	400	(16)	15 M @	400	(16)	15 M @	600	(24)	15 M @	200	(8)	15 M @	400	(16)	15 M @	400	(16)	15 M @	600	(24)	15 M @	600	(24)	15 M @	600	(24)
	2.44	(8.0)	15 M @	200	(8)	15 M @	400	(16)	15 M @	400	(16)	15 M @	600	(24)				15 M @	200	(8)	15 M @	400	(16)	15 M @	400	(16)	15 M @	400	(16)	15 M @	400	(16)
	2.74	(9.0)				15 M @	200	(8)	15 M @	400	(16)	15 M @	400	(16)				15 M @	200	(8)	15 M @	200	(8)	15 M @	400	(16)	15 M @	400	(16)	15 M @	400	(16)
	3.05	(10.0)				15 M @	200	(8)	15 M @	200	(8)	15 M @	400	(16)				15 M @	200	(8)	15 M @	200	(8)	15 M @	200	(8)	15 M @	400	(16)	15 M @	400	(16)
3.35 (11.0)	1.22	(4.0)	15 M @	600	(24)	10 M @	400	(16)	10 M @	400	(16)	10 M @	400	(16)	15 M @	600	(24)	10 M @	400	(16)	10 M @	400	(16)	10 M @	400	(16)	10 M @	400	(16)			
	1.53	(5.0)	15 M @	400	(16)	15 M @	600	(24)	10 M @	400	(16)	10 M @	400	(16)	15 M @	400	(16)	15 M @	600	(24)	10 M @	400	(16)	10 M @	400	(16)	10 M @	400	(16)			
	1.83	(6.0)	15 M @	200	(8)	15 M @	400	(16)	15 M @	600	(24)	15 M @	600	(24)	15 M @	200	(8)	15 M @	400	(16)	15 M @	400	(16)	15 M @	600	(24)	15 M @	600	(24)	15 M @	600	(24)
	2.13	(7.0)	15 M @	200	(8)	15 M @	400	(16)	15 M @	400	(16)	15 M @	600	(24)	15 M @	200	(8)	15 M @	400	(16)	15 M @	400	(16)	15 M @	600	(24)	15 M @	600	(24)	15 M @	600	(24)
	2.44	(8.0)				15 M @	200	(8)	15 M @	400	(16)	15 M @	400	(16)				15 M @	200	(8)	15 M @	400	(16)	15 M @	400	(16)	15 M @	400	(16)	15 M @	400	(16)
	2.74	(9.0)				15 M @	200	(8)	15 M @	200	(8)	15 M @	400	(16)				15 M @	200	(8)	15 M @	200	(8)	15 M @	200	(8)	15 M @	400	(16)	15 M @	400	(16)
	3.05	(10.0)				15 M @	200	(8)	15 M @	200	(8)	15 M @	400	(16)				15 M @	200	(8)	15 M @	200	(8)	15 M @	200	(8)	15 M @	200	(8)	15 M @	200	(8)
3.35	(11.0)				15 M @	200	(8)	15 M @	200	(8)	15 M @	200	(8)				15 M @	200	(8)	15 M @	200	(8)	15 M @	200	(8)	15 M @	200	(8)	15 M @	200	(8)	
3.66 (12.0)	1.22	(4.0)	15 M @	600	(24)	10 M @	400	(16)	10 M @	400	(16)	10 M @	400	(16)	15 M @	600	(24)	15 M @	600	(24)	10 M @	400	(16)	10 M @	400	(16)	10 M @	400	(16)			
	1.53	(5.0)	15 M @	400	(16)	15 M @	600	(24)	10 M @	400	(16)	10 M @	400	(16)	15 M @	400	(16)	15 M @	600	(24)	15 M @	600	(24)	10 M @	400	(16)	10 M @	400	(16)			
	1.83	(6.0)	15 M @	200	(8)	15 M @	400	(16)	15 M @	600	(24)	15 M @	600	(24)	15 M @	200	(8)	15 M @	400	(16)	15 M @	400	(16)	15 M @	600	(24)	15 M @	600	(24)	15 M @	600	(24)
	2.13	(7.0)	15 M @	200	(8)	15 M @	400	(16)	15 M @	400	(16)	15 M @	600	(24)	15 M @	200	(8)	15 M @	200	(8)	15 M @	400	(16)	15 M @	400	(16)	15 M @	600	(24)	15 M @	600	(24)
	2.44	(8.0)				15 M @	200	(8)	15 M @	400	(16)	15 M @	400	(16)				15 M @	200	(8)	15 M @	200	(8)	15 M @	400	(16)	15 M @	400	(16)	15 M @	400	(16)
	2.74	(9.0)				15 M @	200	(8)	15 M @	200	(8)	15 M @	400	(16)				15 M @	200	(8)	15 M @	200	(8)	15 M @	200	(8)	15 M @	400	(16)	15 M @	400	(16)
	3.05	(10.0)				15 M @	200	(8)	15 M @	200	(8)	15 M @	200	(8)							15 M @	200	(8)	15 M @	200	(8)	15 M @	200	(8)	15 M @	200	(8)
	3.35	(11.0)							15 M @	200	(8)	15 M @	200	(8)							15 M @	200	(8)	15 M @	200	(8)	15 M @	200	(8)	15 M @	200	(8)
3.66	(12.0)							15 M @	200	(8)	15 M @	200	(8)													15 M @	200	(8)	15 M @	200	(8)	
Horizontal Reinforcement	Block Height of 12" and 18"		15 M @	450	(18)	15 M @	450	(18)	15 M @	450	(18)	15 M @	450	(18)	15 M @	450	(18)	15 M @	450	(18)	15 M @	450	(18)	15 M @	450	(18)	15 M @	450	(18)			
	Block Height of 16"		15 M @	400	(16)	15 M @	400	(16)	15 M @	400	(16)	15 M @	400	(16)	15 M @	400	(16)	15 M @	400	(16)	15 M @	400	(16)	15 M @	400	(16)	15 M @	400	(16)			

NOTES

1. For highlighted data, where the below grade wall meets all the requirements of NBC Part 9 for a solid concrete foundation wall and supports only wood frame construction above, a 20MPa unreinforced wall is adequate as per 2015 NBC table 9.15.4.2.A. Provide the reinforcing shown for walls supporting ICF walls above or with brick veneer supported with the brick ledge form.
2. Below grade walls supporting "Drained Earth" in accordance with 2015 NBC 9.4.4.6 may be designed for an equivalent fluid pressure of 480 kg/m3.
3. This table is to be used in conjunction with the "Design Limitations" and "Below Grade Reinforcement Placement" drawing.
4. Alternating horizontal bar spacing of 12" o.c. and 24" o.c. may be used to achieve an average spacing of 18" o.c. where 18" o.c. spacing is specified for horizontal bars, as shown in Detail A.3.

Table B.2.2. Continued – Below Grade Wall Distributed Reinforcement for Seismic Zone Classification, 0.25 < Sa(0.2) ≤ 0.70 and Hourly Wind Pressure, q_{1/50} ≤ 1.05kPa, for ICF Walls with 8” Tie Spacing

Wall Height m (ft)	Backfill Height m (ft)		Vertical Steel (Size and Spacing)															
			Backfill Equivalent Fluid Density															
			960 kg/m3 (60 pcf)								1200 kg/m3 (75 pcf)							
		150 mm (6") Wall		200 mm (8") Wall		250 mm (10") Wall		300 mm (12") Wall		150 mm (6") Wall		200 mm (8") Wall		250 mm (10") Wall		300 mm (12") Wall		
2.44 (8.0)	1.22	(4.0)	15 M @ 400	(16)	10 M @ 400	(16)	10 M @ 400	(16)	10 M @ 400	(16)	15 M @ 400	(16)	10 M @ 400	(16)	10 M @ 400	(16)	10 M @ 400	(16)
	1.53	(5.0)	15 M @ 400	(16)	15 M @ 600	(24)	10 M @ 400	(16)	10 M @ 400	(16)	15 M @ 400	(16)	15 M @ 600	(24)	10 M @ 400	(16)	10 M @ 400	(16)
	1.83	(6.0)	15 M @ 400	(16)	15 M @ 400	(16)	15 M @ 600	(24)	10 M @ 400	(16)	15 M @ 200	(8)	15 M @ 400	(16)	15 M @ 600	(24)	10 M @ 400	(16)
	2.13	(7.0)	15 M @ 200	(8)	15 M @ 400	(16)	15 M @ 400	(16)	15 M @ 600	(24)	15 M @ 200	(8)	15 M @ 400	(16)	15 M @ 400	(16)	15 M @ 600	(24)
	2.44	(8.0)	15 M @ 200	(8)	15 M @ 400	(16)	15 M @ 400	(16)	15 M @ 400	(16)	15 M @ 200	(8)	15 M @ 200	(8)	15 M @ 400	(16)	15 M @ 400	(16)
2.74 (9.0)	1.22	(4.0)	15 M @ 600	(24)	15 M @ 600	(24)	10 M @ 400	(16)	10 M @ 400	(16)	15 M @ 600	(24)	15 M @ 600	(24)	10 M @ 400	(16)	10 M @ 400	(16)
	1.53	(5.0)	15 M @ 400	(16)	15 M @ 600	(24)	10 M @ 400	(16)	10 M @ 400	(16)	15 M @ 400	(16)	15 M @ 600	(24)	10 M @ 400	(16)	10 M @ 400	(16)
	1.83	(6.0)	15 M @ 200	(8)	15 M @ 400	(16)	15 M @ 600	(24)	10 M @ 400	(16)	15 M @ 200	(8)	15 M @ 400	(16)	15 M @ 400	(16)	15 M @ 600	(24)
	2.13	(7.0)	15 M @ 200	(8)	15 M @ 400	(16)	15 M @ 400	(16)	15 M @ 600	(24)	15 M @ 200	(8)	15 M @ 400	(16)	15 M @ 400	(16)	15 M @ 400	(16)
	2.44	(8.0)	15 M @ 200	(8)	15 M @ 200	(8)	15 M @ 400	(16)	15 M @ 400	(16)			15 M @ 200	(8)	15 M @ 400	(16)	15 M @ 400	(16)
	2.74	(9.0)			15 M @ 200	(8)	15 M @ 400	(16)	15 M @ 400	(16)			15 M @ 200	(8)	15 M @ 200	(8)	15 M @ 400	(16)
3.05 (10.0)	1.22	(4.0)	15 M @ 600	(24)	15 M @ 600	(24)	10 M @ 400	(16)	10 M @ 400	(16)	15 M @ 600	(24)	15 M @ 600	(24)	10 M @ 400	(16)	10 M @ 400	(16)
	1.53	(5.0)	15 M @ 400	(16)	15 M @ 600	(24)	10 M @ 400	(16)	10 M @ 400	(16)	15 M @ 400	(16)	15 M @ 600	(24)	15 M @ 600	(24)	10 M @ 400	(16)
	1.83	(6.0)	15 M @ 200	(8)	15 M @ 400	(16)	15 M @ 400	(16)	15 M @ 600	(24)	15 M @ 200	(8)	15 M @ 400	(16)	15 M @ 400	(16)	15 M @ 600	(24)
	2.13	(7.0)	15 M @ 200	(8)	15 M @ 400	(16)	15 M @ 400	(16)	15 M @ 400	(16)	15 M @ 200	(8)	15 M @ 200	(8)	15 M @ 400	(16)	15 M @ 400	(16)
	2.44	(8.0)			15 M @ 200	(8)	15 M @ 400	(16)	15 M @ 400	(16)			15 M @ 200	(8)	15 M @ 200	(8)	15 M @ 400	(16)
	2.74	(9.0)			15 M @ 200	(8)	15 M @ 200	(8)	15 M @ 400	(16)			15 M @ 200	(8)	15 M @ 200	(8)	15 M @ 400	(16)
	3.05	(10.0)			15 M @ 200	(8)	15 M @ 200	(8)	15 M @ 200	(8)					15 M @ 200	(8)	15 M @ 200	(8)
3.35 (11.0)	1.22	(4.0)	15 M @ 600	(24)	15 M @ 600	(24)	10 M @ 400	(16)	10 M @ 400	(16)	15 M @ 600	(24)	15 M @ 600	(24)	10 M @ 400	(16)	10 M @ 400	(16)
	1.53	(5.0)	15 M @ 400	(16)	15 M @ 600	(24)	10 M @ 400	(16)	10 M @ 400	(16)	15 M @ 400	(16)	15 M @ 400	(16)	15 M @ 600	(24)	10 M @ 400	(16)
	1.83	(6.0)	15 M @ 200	(8)	15 M @ 400	(16)	15 M @ 400	(16)	15 M @ 600	(24)	15 M @ 200	(8)	15 M @ 400	(16)	15 M @ 400	(16)	15 M @ 600	(24)
	2.13	(7.0)	15 M @ 200	(8)	15 M @ 200	(8)	15 M @ 400	(16)	15 M @ 400	(16)			15 M @ 200	(8)	15 M @ 400	(16)	15 M @ 400	(16)
	2.44	(8.0)			15 M @ 200	(8)	15 M @ 200	(8)	15 M @ 400	(16)			15 M @ 200	(8)	15 M @ 200	(8)	15 M @ 400	(16)
	2.74	(9.0)			15 M @ 200	(8)	15 M @ 200	(8)	15 M @ 400	(16)			15 M @ 200	(8)	15 M @ 200	(8)	15 M @ 200	(8)
	3.05	(10.0)					15 M @ 200	(8)	15 M @ 200	(8)					15 M @ 200	(8)	15 M @ 200	(8)
3.66 (12.0)	1.22	(4.0)	15 M @ 600	(24)	15 M @ 600	(24)	10 M @ 400	(16)	10 M @ 400	(16)	15 M @ 400	(16)	15 M @ 600	(24)	10 M @ 400	(16)	10 M @ 400	(16)
	1.53	(5.0)	15 M @ 400	(16)	15 M @ 600	(24)	15 M @ 600	(24)	10 M @ 400	(16)	15 M @ 400	(16)	15 M @ 400	(16)	15 M @ 600	(24)	10 M @ 400	(16)
	1.83	(6.0)	15 M @ 200	(8)	15 M @ 400	(16)	15 M @ 400	(16)	15 M @ 600	(24)	15 M @ 200	(8)	15 M @ 400	(16)	15 M @ 400	(16)	15 M @ 600	(24)
	2.13	(7.0)			15 M @ 200	(8)	15 M @ 400	(16)	15 M @ 400	(16)			15 M @ 200	(8)	15 M @ 400	(16)	15 M @ 400	(16)
	2.44	(8.0)			15 M @ 200	(8)	15 M @ 200	(8)	15 M @ 400	(16)			15 M @ 200	(8)	15 M @ 200	(8)	15 M @ 400	(16)
	2.74	(9.0)			15 M @ 200	(8)	15 M @ 200	(8)	15 M @ 200	(8)					15 M @ 200	(8)	15 M @ 200	(8)
	3.05	(10.0)					15 M @ 200	(8)	15 M @ 200	(8)							15 M @ 200	(8)
	3.35	(11.0)							15 M @ 200	(8)							15 M @ 200	(8)
	3.66	(12.0)																
Horizontal Reinforcement	Block Height of 12" and 18"		15 M @ 450	(18)	15 M @ 450	(18)	15 M @ 450	(18)	15 M @ 450	(18)	15 M @ 450	(18)	15 M @ 450	(18)	15 M @ 450	(18)	15 M @ 450	(18)
	Block Height of 16"		15 M @ 400	(16)	15 M @ 400	(16)	15 M @ 400	(16)	15 M @ 400	(16)	15 M @ 400	(16)	15 M @ 400	(16)	15 M @ 400	(16)	15 M @ 400	(16)

NOTES

- For highlighted data, where the below grade wall meets all the requirements of NBC Part 9 for a solid concrete foundation wall and supports only wood frame construction above, a 20MPa unreinforced wall is adequate as per 2015 NBC table 9.15.4.2.A. Provide the reinforcing shown for walls supporting ICF walls above or with brick veneer supported with the brick ledge form.
- Below grade walls supporting "Drained Earth" in accordance with 2015 NBC 9.4.4.6 may be designed for an equivalent fluid pressure of 480 kg/m3.
- This table is to be used in conjunction with the "Design Limitations" and "Below Grade Reinforcement Placement" drawing.
- Alternating horizontal bar spacing of 12" o.c. and 24" o.c. may be used to achieve an average spacing of 18" o.c. where 18" o.c. spacing is specified for horizontal bars, as shown in Detail A.3.

Table B.4.2. – Below Grade Wall Distributed Reinforcement for Seismic Zone Classification, $1.2 < Sa(0.2) \leq 1.75$ and Hourly Wind Pressure, $q_{1/50} \leq 1.05kPa$, for ICF Walls with 8” Tie Spacing

Wall Height m (ft)	Backfill Height m (ft)	Vertical Steel (Size and Spacing)																							
		Backfill Equivalent Fluid Density																							
		480 kg/m3 (30 pcf)								720 kg/m3 (45 pcf)															
150 mm (6”) Wall		200 mm (8”) Wall			250 mm (10”) Wall			300 mm (12”) Wall			150 mm (6”) Wall		200 mm (8”) Wall			250 mm (10”) Wall			300 mm (12”) Wall						
2.44 (8.0)	1.22 (4.0)	10 M @	200	(8)	15 M @	600	(24)	10 M @	400	(16)	10 M @	400	(16)	15 M @	400	(16)	15 M @	600	(24)	10 M @	400	(16)	10 M @	400	(16)
	1.53 (5.0)	15 M @	200	(8)	15 M @	400	(16)	10 M @	200	(8)	10 M @	200	(8)	15 M @	200	(8)	15 M @	400	(16)	10 M @	200	(8)	10 M @	200	(8)
	1.83 (6.0)	15 M @	200	(8)	15 M @	400	(16)	15 M @	400	(16)	10 M @	200	(8)	15 M @	200	(8)	15 M @	400	(16)	15 M @	400	(16)	10 M @	200	(8)
	2.13 (7.0)				15 M @	200	(8)	15 M @	400	(16)	15 M @	400	(16)				15 M @	200	(8)	15 M @	400	(16)	15 M @	400	(16)
	2.44 (8.0)				15 M @	200	(8)	15 M @	200	(8)	15 M @	400	(16)				15 M @	200	(8)	15 M @	200	(8)	15 M @	400	(16)
2.74 (9.0)	1.22 (4.0)	10 M @	200	(8)	15 M @	600	(24)	10 M @	400	(16)	10 M @	400	(16)	10 M @	200	(8)	15 M @	600	(24)	10 M @	400	(16)	10 M @	400	(16)
	1.53 (5.0)	15 M @	200	(8)	15 M @	400	(16)	10 M @	200	(8)	10 M @	200	(8)	15 M @	200	(8)	15 M @	400	(16)	10 M @	200	(8)	15 M @	600	(24)
	1.83 (6.0)	15 M @	200	(8)	15 M @	200	(8)	15 M @	400	(16)	10 M @	200	(8)				15 M @	200	(8)	15 M @	400	(16)	15 M @	400	(16)
	2.13 (7.0)				15 M @	200	(8)	15 M @	200	(8)	15 M @	400	(16)				15 M @	200	(8)	15 M @	200	(8)	15 M @	400	(16)
	2.44 (8.0)				15 M @	200	(8)	15 M @	200	(8)	15 M @	200	(8)				15 M @	200	(8)	15 M @	200	(8)	15 M @	200	(8)
3.05 (10.0)	1.22 (4.0)	10 M @	200	(8)	15 M @	600	(24)	10 M @	400	(16)	10 M @	400	(16)	10 M @	200	(8)	15 M @	600	(24)	10 M @	400	(16)	10 M @	400	(16)
	1.53 (5.0)	15 M @	200	(8)	15 M @	400	(16)	10 M @	200	(8)	15 M @	600	(24)	15 M @	200	(8)	15 M @	400	(16)	10 M @	200	(8)	15 M @	600	(24)
	1.83 (6.0)				15 M @	200	(8)	15 M @	400	(16)	15 M @	400	(16)				15 M @	200	(8)	15 M @	400	(16)	15 M @	400	(16)
	2.13 (7.0)				15 M @	200	(8)	15 M @	200	(8)	15 M @	400	(16)				15 M @	200	(8)	15 M @	200	(8)	15 M @	400	(16)
	2.44 (8.0)							15 M @	200	(8)	15 M @	200	(8)				15 M @	200	(8)				15 M @	200	(8)
	2.74 (9.0)							15 M @	200	(8)	15 M @	200	(8)										15 M @	200	(8)
	3.05 (10.0)										15 M @	200	(8)										15 M @	200	(8)
3.35 (11.0)	1.22 (4.0)	10 M @	200	(8)	15 M @	600	(24)	10 M @	400	(16)	10 M @	400	(16)	10 M @	200	(8)	15 M @	600	(24)	10 M @	400	(16)	10 M @	400	(16)
	1.53 (5.0)	15 M @	200	(8)	15 M @	400	(16)	10 M @	200	(8)	15 M @	600	(24)	15 M @	200	(8)	15 M @	400	(16)	15 M @	400	(16)	10 M @	200	(8)
	1.83 (6.0)				15 M @	200	(8)	15 M @	400	(16)	15 M @	400	(16)				15 M @	200	(8)	15 M @	200	(8)	15 M @	400	(16)
	2.13 (7.0)				15 M @	200	(8)	15 M @	200	(8)	15 M @	200	(8)				15 M @	200	(8)	15 M @	200	(8)	15 M @	200	(8)
	2.44 (8.0)							15 M @	200	(8)	15 M @	200	(8)				15 M @	200	(8)				15 M @	200	(8)
	2.74 (9.0)										15 M @	200	(8)										15 M @	200	(8)
	3.05 (10.0)										15 M @	200	(8)												
3.66 (12.0)	1.22 (4.0)	10 M @	200	(8)	15 M @	600	(24)	10 M @	400	(16)	10 M @	400	(16)	10 M @	200	(8)	10 M @	200	(8)	10 M @	400	(16)	10 M @	400	(16)
	1.53 (5.0)	15 M @	200	(8)	15 M @	400	(16)	10 M @	200	(8)	15 M @	600	(24)	15 M @	200	(8)	15 M @	400	(16)	15 M @	400	(16)	10 M @	200	(8)
	1.83 (6.0)				15 M @	200	(8)	15 M @	200	(8)	15 M @	400	(16)				15 M @	200	(8)	15 M @	200	(8)	15 M @	400	(16)
	2.13 (7.0)							15 M @	200	(8)	15 M @	200	(8)				15 M @	200	(8)	15 M @	200	(8)	15 M @	200	(8)
	2.44 (8.0)										15 M @	200	(8)										15 M @	200	(8)
	2.74 (9.0)										15 M @	200	(8)												
	3.05 (10.0)																								
	3.66 (12.0)																								
Horizontal Reinforcement	Block Height of 12" and 18"	15 M @	300	(12)	15 M @	300	(12)	15 M @	300	(12)	15 M @	300	(12)	15 M @	300	(12)	15 M @	300	(12)	15 M @	300	(12)	15 M @	300	(12)
	Block Height of 16"	15 M @	300	(12)	15 M @	300	(12)	15 M @	300	(12)	15 M @	300	(12)	15 M @	300	(12)	15 M @	300	(12)	15 M @	300	(12)	15 M @	300	(12)

NOTES

1. For highlighted data, where the below grade wall meets all the requirements of NBC Part 9 for a solid concrete foundation wall and supports only wood frame construction above, a 20MPa unreinforced wall is adequate as per 2015 NBC table 9.15.4.2.A. Provide the reinforcing shown for walls supporting ICF walls above or with brick veneer supported with the brick ledge form.
2. Below grade walls supporting "Drained Earth" in accordance with 2015 NBC 9.4.4.6 may be designed for an equivalent fluid pressure of 480 kg/m3.
3. This table is to be used in conjunction with the "Design Limitations" and "Below Grade Reinforcement Placement" drawing.
4. Provide 3 horizontal bars in every two rows of 18" high block to achieve an average spacing of 12" o.c. where 12" spacing o.c. is specified for horizontal bars, as shown in Detail A.4.
5. Provide 4 horizontal bars in every three rows of 16" high block to achieve an average spacing of 12" o.c. where 12" spacing o.c. is specified for horizontal bars, as shown in Detail A.5.

Table B.4.2. Continued– Below Grade Wall Distributed Reinforcement for Seismic Zone Classification, 1.2 < Sa(0.2) ≤ 1.75 and Hourly Wind Pressure, $q_{1/50} ≤ 1.05$ kPa, for ICF Walls with 8" Tie Spacing

Wall Height m (ft)	Backfill Height m (ft)		Vertical Steel (Size and Spacing)																																
			Backfill Equivalent Fluid Density																																
			960 kg/m ³ (60 pcf)								1200 kg/m ³ (75 pcf)																								
		150 mm (6") Wall		200 mm (8") Wall		250 mm (10") Wall		300 mm (12") Wall		150 mm (6") Wall		200 mm (8") Wall		250 mm (10") Wall		300 mm (12") Wall																			
2.44 (8.0)	1.22	(4.0)	15 M @	400	(16)	15 M @	600	(24)	10 M @	400	(16)	10 M @	400	(16)	15 M @	400	(16)	10 M @	200	(8)	15 M @	400	(16)	10 M @	200	(8)	15 M @	600	(24)						
	1.53	(5.0)	15 M @	200	(8)	15 M @	400	(16)	10 M @	200	(8)	10 M @	200	(8)	15 M @	200	(8)	15 M @	400	(16)	10 M @	200	(8)	15 M @	400	(16)	15 M @	400	(16)	10 M @	200	(8)			
	1.83	(6.0)	15 M @	200	(8)	15 M @	200	(8)	15 M @	400	(16)	10 M @	200	(8)	15 M @	200	(8)	15 M @	200	(8)	15 M @	400	(16)	15 M @	400	(16)	15 M @	400	(16)	15 M @	400	(16)			
	2.13	(7.0)				15 M @	200	(8)	15 M @	200	(8)	15 M @	400	(16)				15 M @	200	(8)	15 M @	200	(8)	15 M @	400	(16)	15 M @	400	(16)	15 M @	400	(16)			
	2.44	(8.0)				15 M @	200	(8)	15 M @	200	(8)	15 M @	400	(16)				15 M @	200	(8)	15 M @	200	(8)	15 M @	400	(16)	15 M @	400	(16)	15 M @	400	(16)			
2.74 (9.0)	1.22	(4.0)	10 M @	200	(8)	10 M @	200	(8)	10 M @	400	(16)	10 M @	400	(16)	10 M @	200	(8)	10 M @	200	(8)	10 M @	400	(16)	10 M @	400	(16)	10 M @	400	(16)	10 M @	400	(16)			
	1.53	(5.0)	15 M @	200	(8)	15 M @	400	(16)	10 M @	200	(8)	15 M @	600	(24)	15 M @	200	(8)	15 M @	400	(16)	15 M @	400	(16)	15 M @	400	(16)	10 M @	200	(8)						
	1.83	(6.0)				15 M @	200	(8)	15 M @	400	(16)	15 M @	400	(16)				15 M @	200	(8)	15 M @	400	(16)	15 M @	400	(16)	15 M @	400	(16)	15 M @	400	(16)			
	2.13	(7.0)				15 M @	200	(8)	15 M @	200	(8)	15 M @	400	(16)				15 M @	200	(8)	15 M @	200	(8)	15 M @	400	(16)	15 M @	400	(16)	15 M @	400	(16)			
	2.44	(8.0)							15 M @	200	(8)	15 M @	200	(8)										15 M @	200	(8)	15 M @	200	(8)	15 M @	200	(8)			
	2.74	(9.0)							15 M @	200	(8)	15 M @	200	(8)										15 M @	200	(8)	15 M @	200	(8)	15 M @	200	(8)			
3.05 (10.0)	1.22	(4.0)	10 M @	200	(8)	10 M @	200	(8)	10 M @	400	(16)	10 M @	400	(16)	10 M @	200	(8)	10 M @	200	(8)	15 M @	600	(24)	10 M @	400	(16)									
	1.53	(5.0)	15 M @	200	(8)	15 M @	400	(16)	15 M @	400	(16)	10 M @	200	(8)	15 M @	200	(8)	15 M @	400	(16)	15 M @	400	(16)	10 M @	200	(8)									
	1.83	(6.0)				15 M @	200	(8)	15 M @	200	(8)	15 M @	400	(16)				15 M @	200	(8)	15 M @	200	(8)	15 M @	400	(16)	15 M @	400	(16)	15 M @	400	(16)			
	2.13	(7.0)				15 M @	200	(8)	15 M @	200	(8)	15 M @	200	(8)				15 M @	200	(8)	15 M @	200	(8)	15 M @	200	(8)	15 M @	400	(16)	15 M @	200	(8)			
	2.44	(8.0)							15 M @	200	(8)	15 M @	200	(8)									15 M @	200	(8)	15 M @	200	(8)	15 M @	200	(8)	15 M @	200	(8)	
	2.74	(9.0)										15 M @	200	(8)													15 M @	200	(8)	15 M @	200	(8)	15 M @	200	(8)
	3.05	(10.0)										15 M @	200	(8)																					
3.35 (11.0)	1.22	(4.0)	10 M @	200	(8)	10 M @	200	(8)	10 M @	400	(16)	10 M @	400	(16)	10 M @	200	(8)	10 M @	200	(8)	15 M @	600	(24)	10 M @	400	(16)									
	1.53	(5.0)	15 M @	200	(8)	15 M @	400	(16)	15 M @	400	(16)	10 M @	200	(8)	15 M @	200	(8)	15 M @	400	(16)	15 M @	400	(16)	10 M @	200	(8)									
	1.83	(6.0)				15 M @	200	(8)	15 M @	200	(8)	15 M @	400	(16)				15 M @	200	(8)	15 M @	200	(8)	15 M @	400	(16)	15 M @	400	(16)	15 M @	400	(16)	15 M @	400	(16)
	2.13	(7.0)							15 M @	200	(8)	15 M @	200	(8)							15 M @	200	(8)	15 M @	200	(8)	15 M @	400	(16)	15 M @	200	(8)	15 M @	200	(8)
	2.44	(8.0)										15 M @	200	(8)													15 M @	200	(8)	15 M @	200	(8)	15 M @	200	(8)
	2.74	(9.0)										15 M @	200	(8)																					
	3.05	(10.0)																																	
	3.35	(11.0)																																	
3.66 (12.0)	1.22	(4.0)	10 M @	200	(8)	10 M @	200	(8)	10 M @	400	(16)	10 M @	400	(16)	10 M @	200	(8)	10 M @	200	(8)	15 M @	600	(24)	10 M @	400	(16)									
	1.53	(5.0)	15 M @	200	(8)	15 M @	400	(16)	15 M @	400	(16)	10 M @	200	(8)	15 M @	200	(8)	15 M @	400	(16)	15 M @	400	(16)	10 M @	200	(8)									
	1.83	(6.0)				15 M @	200	(8)	15 M @	200	(8)	15 M @	400	(16)				15 M @	200	(8)	15 M @	200	(8)	15 M @	400	(16)	15 M @	400	(16)	15 M @	400	(16)	15 M @	400	(16)
	2.13	(7.0)							15 M @	200	(8)	15 M @	200	(8)							15 M @	200	(8)	15 M @	200	(8)	15 M @	400	(16)	15 M @	200	(8)	15 M @	200	(8)
	2.44	(8.0)										15 M @	200	(8)													15 M @	200	(8)	15 M @	200	(8)	15 M @	200	(8)
	2.74	(9.0)																																	
	3.05	(10.0)																																	
	3.35	(11.0)																																	
	3.66	(12.0)																																	
Horizontal Reinforcement	Block Height of 12" and 18"	15 M @	300	(12)	15 M @	300	(12)	15 M @	300	(12)	15 M @	300	(12)	15 M @	300	(12)	15 M @	300	(12)	15 M @	300	(12)	15 M @	300	(12)	15 M @	300	(12)	15 M @	300	(12)	15 M @	300	(12)	
	Block Height of 16"	15 M @	300	(12)	15 M @	300	(12)	15 M @	300	(12)	15 M @	300	(12)	15 M @	300	(12)	15 M @	300	(12)	15 M @	300	(12)	15 M @	300	(12)	15 M @	300	(12)	15 M @	300	(12)	15 M @	300	(12)	

NOTES

1. For highlighted data, where the below grade wall meets all the requirements of NBC Part 9 for a solid concrete foundation wall and supports only wood frame construction above, a 20MPa unreinforced wall is adequate as per 2015 NBC table 9.15.4.2.A. Provide the reinforcing shown for walls supporting ICF walls above or with brick veneer supported with the brick ledge form.
2. Below grade walls supporting "Drained Earth" in accordance with 2015 NBC 9.4.4.6 may be designed for an equivalent fluid pressure of 480 kg/m3.
3. This table is to be used in conjunction with the "Design Limitations" and "Below Grade Reinforcement Placement" drawing.
4. Provide 3 horizontal bars in every two rows of 18" high block to achieve an average spacing of 12" o.c. where 12" spacing o.c. is specified for horizontal bars, as shown in Detail A.4.
5. Provide 4 horizontal bars in every three rows of 16" high block to achieve an average spacing of 12" o.c. where 12" spacing o.c. is specified for horizontal bars, as shown in Detail A.5.

Table A.1.1. Above Grade Wall Distributed Reinforcement for Seismic Zone Classification, $S_{a,ICF} \leq 0.2$ and Hourly Wind Pressure, $q_{1/50} \leq 1.05$ for ICF Walls with 6" Tie Spacing

Wall Height		Distributed Vertical Reinforcement (Size and Spacing)											
m	(ft)	150 mm (6") Wall			200 mm (8") Wall			250 mm (10") Wall			300 mm (12") Wall		
Hourly Wind Pressure $q_{1/50} \leq 0.5$ kPa													
2.44	(8)	10 M @	600	(24)	10 M @	750	(30)	10 M @	900	(36)	10 M @	1200	(48)
2.75	(9)	10 M @	600	(24)	10 M @	750	(30)	10 M @	900	(36)	10 M @	1200	(48)
3.05	(10)	15 M @	1050	(42)	10 M @	750	(30)	10 M @	900	(36)	10 M @	1200	(48)
3.66	(12)	15 M @	750	(30)	15 M @	1050	(42)	10 M @	600	(24)	10 M @	1200	(48)
4.27	(14)	15 M @	450	(18)	15 M @	750	(30)	15 M @	1050	(42)	10 M @	1200	(48)
4.88	(16)	15 M @	300	(12)	15 M @	600	(24)	15 M @	750	(30)	10 M @	900	(36)
Hourly Wind Pressure $q_{1/50} \leq 0.75$ kPa													
2.44	(8)	15 M @	1050	(42)	10 M @	750	(30)	10 M @	900	(36)	10 M @	1200	(48)
2.75	(9)	15 M @	750	(30)	10 M @	600	(24)	10 M @	750	(30)	10 M @	1200	(48)
3.05	(10)	15 M @	600	(24)	15 M @	1050	(42)	10 M @	600	(24)	10 M @	1200	(48)
3.66	(12)	15 M @	300	(12)	15 M @	750	(30)	15 M @	900	(36)	10 M @	1200	(48)
4.27	(14)	15 M @	300	(12)	15 M @	450	(18)	15 M @	750	(30)	10 M @	900	(36)
4.88	(16)	15 M @	300	(12)	15 M @	450	(18)	15 M @	450	(18)	15 M @	900	(36)
Hourly Wind Pressure $q_{1/50} \leq 1.05$ kPa													
2.44	(8)	15 M @	750	(30)	15 M @	1050	(42)	10 M @	600	(24)	10 M @	1200	(48)
2.75	(9)	15 M @	600	(24)	15 M @	900	(36)	15 M @	1200	(48)	10 M @	1200	(48)
3.05	(10)	15 M @	450	(18)	15 M @	750	(30)	15 M @	900	(36)	10 M @	900	(36)
3.66	(12)	15 M @	300	(12)	15 M @	450	(18)	15 M @	600	(24)	10 M @	750	(30)
4.27	(14)	15 M @	300	(12)	15 M @	450	(18)	15 M @	450	(18)	15 M @	900	(36)
4.88	(16)				15 M @	300	(12)	15 M @	450	(18)	15 M @	750	(30)
Horizontal Reinforcement	Block Height of 12" and 18"	10 M @	900	(36)	10 M @	900	(36)	10 M @	900	(36)	10 M @	900	(36)
	Block Height of 16"	10 M @	800	(32)	10 M @	800	(32)	10 M @	800	(32)	10 M @	800	(32)

NOTES

1. $S_{a,ICF}$ is equivalent spectral response acceleration for ICF walls as provided in Appendix A.
2. Provide two layers of the indicated horizontal and vertical distributed steel specified for 300mm (12") walls. Place each layer as shown in the rebar placement drawing.
3. This table is to be used in conjunction with the "Design Limitations."
4. Bolded data indicates reinforcing for ground floor concrete walls only. Second floor concrete walls to be limited in height to 3.0m (10'-0").

Table A.1.2. Above Grade Wall Distributed Reinforcement for Seismic Zone Classification, $S_{a,ICF} \leq 0.2$ and Hourly Wind Pressure, $q_{1/50} \leq 1.05$ for Walls with 8" Tie Spacing

Wall Height		Distributed Vertical Reinforcement (Size and Spacing)															
m	(ft)	150 mm (6") Wall				200 mm (8") Wall				250 mm (10") Wall				300 mm (12") Wall			
Hourly Wind Pressure $q_{1/50} \leq 0.5$ kPa																	
2.44	(8)	10 M @	600	(24)	10 M @	800	(32)	10 M @	1000	(40)	10 M @	1200	(48)				
2.75	(9)	10 M @	600	(24)	10 M @	800	(32)	10 M @	1000	(40)	10 M @	1200	(48)				
3.05	(10)	15 M @	1000	(40)	10 M @	600	(24)	10 M @	800	(32)	10 M @	1200	(48)				
3.66	(12)	15 M @	600	(24)	15 M @	1000	(40)	10 M @	600	(24)	10 M @	1200	(48)				
4.27	(14)	15 M @	400	(16)	15 M @	800	(32)	15 M @	1000	(40)	10 M @	1200	(48)				
4.88	(16)	15 M @	400	(16)	15 M @	600	(24)	15 M @	800	(32)	10 M @	1000	(40)				
Hourly Wind Pressure $q_{1/50} \leq 0.75$ kPa																	
2.44	(8)	15 M @	1200	(48)	10 M @	800	(32)	10 M @	1200	(48)	10 M @	1200	(48)				
2.75	(9)	15 M @	800	(32)	10 M @	800	(32)	10 M @	800	(32)	10 M @	1200	(48)				
3.05	(10)	15 M @	800	(32)	15 M @	1200	(48)	10 M @	800	(32)	10 M @	1200	(48)				
3.66	(12)	15 M @	400	(16)	15 M @	800	(32)	15 M @	1200	(48)	10 M @	1200	(48)				
4.27	(14)	15 M @	400	(16)	15 M @	600	(24)	15 M @	800	(32)	10 M @	1200	(48)				
4.88	(16)	15 M @	300	(12)	15 M @	400	(16)	15 M @	600	(24)	15 M @	800	(32)				
Hourly Wind Pressure $q_{1/50} \leq 1.05$ kPa																	
2.44	(8)	15 M @	600	(24)	15 M @	1000	(40)	10 M @	600	(24)	10 M @	1200	(48)				
2.75	(9)	15 M @	600	(24)	15 M @	800	(32)	15 M @	1200	(48)	10 M @	1200	(48)				
3.05	(10)	15 M @	400	(16)	15 M @	800	(32)	15 M @	800	(32)	10 M @	800	(32)				
3.66	(12)	15 M @	300	(12)	15 M @	400	(16)	15 M @	600	(24)	10 M @	800	(32)				
4.27	(14)	15 M @	300	(12)	15 M @	400	(16)	15 M @	400	(16)	15 M @	800	(32)				
4.88	(16)				15 M @	300	(12)	15 M @	400	(16)	15 M @	600	(24)				
Horizontal Reinforcement	Block Height of 12" and 18"	10 M @	900	(36)	10 M @	900	(36)	10 M @	900	(36)	10 M @	900	(36)				
	Block Height of 16"	10 M @	800	(32)	10 M @	800	(32)	10 M @	800	(32)	10 M @	800	(32)				

NOTES

1. $S_{a,ICF}$ is equivalent spectral response acceleration for ICF walls as provided in Appendix A.
2. Provide two layers of the indicated horizontal and vertical distributed steel specified for 300mm (12") walls. Place each layer as shown in the rebar placement drawing.
3. This table is to be used in conjunction with the "Design Limitations."
4. Bolded data indicates reinforcing for ground floor concrete walls only. Second floor concrete walls to be limited in height to 3.0m (10'-0").
5. Alternating vertical bar spacing of 8" o.c. and 16" o.c. may be used to achieve an average spacing of 12" o.c. where 12" o.c. spacing is specified for vertical bars, as shown in Detail A.5.

Table A.2.1. Above Grade Wall Distributed Reinforcement for Seismic Zone Classification, $S_{a,ICF} \geq 0.2$ and Hourly Wind Pressure, $q_{1/50} \leq 1.05$ for ICF Walls with 6" Tie Spacing

Wall Height		Distributed Vertical Reinforcement (Size and Spacing)											
m	(ft)	150 mm (6") Wall			200 mm (8") Wall			250 mm (10") Wall			300 mm (12") Wall		
Seismic zone classification, $S_{a,ICF} \leq 0.4$													
2.44	(8)	10 M @	300	(12)	10 M @	300	(12)	10 M @	300	(12)	10 M @	450	(18)
2.75	(9)	10 M @	300	(12)	10 M @	300	(12)	10 M @	300	(12)	10 M @	450	(18)
3.05	(10)	15 M @	450	(18)	10 M @	300	(12)	10 M @	300	(12)	10 M @	450	(18)
3.66	(12)	15 M @	300	(12)	15 M @	450	(18)	15 M @	600	(24)	10 M @	450	(18)
4.27	(14)	15 M @	300	(12)	15 M @	450	(18)	15 M @	450	(18)	10 M @	450	(18)
4.88	(16)				15 M @	300	(12)	15 M @	300	(12)	10 M @	450	(18)
Horizontal Reinforcement	Block Height of 12" and 18"	15 M @	450	(18)	15 M @	450	(18)	15 M @	450	(18)	10 M @	450	(18)
	Block Height of 16"	15 M @	400	(16)	15 M @	400	(16)	15 M @	400	(16)	10 M @	400	(16)
Seismic zone classification, $S_{a,ICF} \leq 0.7$													
2.44	(8)	15 M @	300	(12)	15 M @	450	(18)	15 M @	450	(18)	10 M @	300	(12)
2.75	(9)	15 M @	300	(12)	15 M @	450	(18)	15 M @	450	(18)	10 M @	300	(12)
3.05	(10)	15 M @	300	(12)	15 M @	450	(18)	15 M @	450	(18)	10 M @	300	(12)
3.66	(12)	15 M @	300	(12)	15 M @	450	(18)	15 M @	450	(18)	10 M @	300	(12)
4.27	(14)	15 M @	300	(12)	15 M @	450	(18)	15 M @	450	(18)	10 M @	300	(12)
4.88	(16)				15 M @	300	(12)	15 M @	450	(18)	10 M @	300	(12)
Horizontal Reinforcement	Block Height of 12" and 18"	15 M @	300	(12)	15 M @	300	(12)	15 M @	300	(12)	10 M @	300	(12)
	Block Height of 16"	15 M @	300	(12)	15 M @	300	(12)	15 M @	300	(12)	10 M @	300	(12)
Seismic zone classification, $S_{a,ICF} \leq 1.05$													
2.44	(8)	15 M @	300	(12)	15 M @	300	(12)	15 M @	300	(12)	10 M @	300	(12)
2.75	(9)	15 M @	300	(12)	15 M @	300	(12)	15 M @	300	(12)	10 M @	300	(12)
3.05	(10)	15 M @	300	(12)	15 M @	300	(12)	15 M @	300	(12)	10 M @	300	(12)
3.66	(12)	15 M @	300	(12)	15 M @	300	(12)	15 M @	300	(12)	10 M @	300	(12)
4.27	(14)	15 M @	300	(12)	15 M @	300	(12)	15 M @	300	(12)	10 M @	300	(12)
4.88	(16)				15 M @	300	(12)	15 M @	300	(12)	10 M @	300	(12)
Horizontal Reinforcement	Block Height of 12" and 18"	15 M @	300	(12)	15 M @	300	(12)	15 M @	300	(12)	15 M @	300	(12)
	Block Height of 16"	15 M @	300	(12)	15 M @	300	(12)	15 M @	300	(12)	15 M @	300	(12)

NOTES

- $S_{a,ICF}$ is equivalent spectral response acceleration for ICF walls as provided in Appendix A.
- This table is to be used in conjunction with the "Design Limitations."
- Bolded data indicates reinforcing for ground floor concrete walls only. Second floor concrete walls to be limited in height to 3.0m (10'-0").
- Provide two layers of the indicated horizontal and vertical distributed steel specified for 300mm (12") walls. Place each layer as shown in the rebar placement drawing.
- Alternating horizontal bar spacing of 12" o.c. and 24" o.c. may be used to achieve an average spacing of 18" o.c. where 18" o.c. spacing is specified for horizontal bars, as shown in Detail A.3.
- Provide 3 horizontal bars in every two rows of 18" high block to achieve an average spacing of 12" o.c. where 12" spacing o.c. is specified for horizontal bars, as shown in Detail A.4.
- Provide 4 horizontal bars in every three rows of 16" high block to achieve an average spacing of 12" o.c. where 12" spacing o.c. is specified for horizontal bars, as shown in Detail A.5.

Table A.2.2. Above Grade Wall Distributed Reinforcement for Seismic Zone Classification, $S_{a,ICF} \geq 0.2$ and Hourly Wind Pressure, $q_{1/50} \leq 1.05$ for ICF Walls with 8" Tie Spacing

Wall Height		Distributed Vertical Reinforcement (Size and Spacing)											
m	(ft)	150 mm (6") Wall			200 mm (8") Wall			250 mm (10") Wall			300 mm (12") Wall		
Seismic zone classification, $S_{a,ICF} \leq 0.4$													
2.44	(8)	10 M @	300	(12)	10 M @	300	(12)	10 M @	300	(12)	10 M @	400	(16)
2.75	(9)	10 M @	300	(12)	10 M @	300	(12)	10 M @	300	(12)	10 M @	400	(16)
3.05	(10)	15 M @	400	(16)	10 M @	300	(12)	10 M @	300	(12)	10 M @	400	(16)
3.66	(12)	15 M @	300	(12)	15 M @	400	(16)	15 M @	400	(16)	10 M @	400	(16)
4.27	(14)	15 M @	300	(12)	15 M @	400	(16)	15 M @	400	(16)	10 M @	400	(16)
4.88	(16)				15 M @	300	(12)	15 M @	400	(16)	10 M @	400	(16)
Horizontal Reinforcement	Block Height of 12" and 18"	15 M @	450	(18)	15 M @	450	(18)	15 M @	450	(18)	10 M @	450	(18)
	Block Height of 16"	15 M @	400	(16)	15 M @	400	(16)	15 M @	400	(16)	10 M @	400	(16)
Seismic zone classification, $S_{a,ICF} \leq 0.7$													
2.44	(8)	15 M @	300	(12)	15 M @	400	(16)	15 M @	400	(16)	10 M @	400	(16)
2.75	(9)	15 M @	300	(12)	15 M @	400	(16)	15 M @	400	(16)	10 M @	400	(16)
3.05	(10)	15 M @	300	(12)	15 M @	400	(16)	15 M @	400	(16)	10 M @	400	(16)
3.66	(12)	15 M @	300	(12)	15 M @	400	(16)	15 M @	400	(16)	10 M @	400	(16)
4.27	(14)	15 M @	300	(12)	15 M @	400	(16)	15 M @	400	(16)	10 M @	400	(16)
4.88	(16)				15 M @	400	(16)	15 M @	400	(16)	10 M @	400	(16)
Horizontal Reinforcement	Block Height of 12" and 18"	15 M @	300	(12)	15 M @	300	(12)	15 M @	300	(12)	15 M @	300	(12)
	Block Height of 16"	15 M @	300	(12)	15 M @	300	(12)	15 M @	300	(12)	15 M @	300	(12)
Seismic zone classification, $S_{a,ICF} \leq 1.05$													
2.44	(8)	15 M @	300	(12)	15 M @	300	(12)	15 M @	300	(12)	10 M @	300	(12)
2.75	(9)	15 M @	300	(12)	15 M @	300	(12)	15 M @	300	(12)	10 M @	300	(12)
3.05	(10)	15 M @	300	(12)	15 M @	300	(12)	15 M @	300	(12)	10 M @	300	(12)
3.66	(12)	15 M @	300	(12)	15 M @	300	(12)	15 M @	300	(12)	10 M @	300	(12)
4.27	(14)	15 M @	300	(12)	15 M @	300	(12)	15 M @	300	(12)	10 M @	300	(12)
4.88	(16)				15 M @	300	(12)	15 M @	300	(12)	15 M @	300	(12)
Horizontal Reinforcement	Block Height of 12" and 18"	15 M @	300	(12)	15 M @	300	(12)	15 M @	300	(12)	15 M @	300	(12)
	Block Height of 16"	15 M @	300	(12)	15 M @	300	(12)	15 M @	300	(12)	15 M @	300	(12)

NOTES

- $S_{a,ICF}$ is equivalent spectral response acceleration for ICF walls as provided in Appendix A.
- This table is to be used in conjunction with the "Design Limitations."
- Bolded data indicates reinforcing for ground floor concrete walls only. Second floor concrete walls to be limited in height to 3.0m (10'-0").
- Provide two layers of the indicated horizontal and vertical distributed steel specified for 300mm (12") walls. Place each layer as shown in the rebar placement drawing.
- Alternating horizontal bar spacing of 12" o.c. and 24" o.c. may be used to achieve an average spacing of 18" o.c. where 18" o.c. spacing is specified for horizontal bars, as shown in Detail A.3.
- Provide 3 horizontal bars in every two rows of 18" high block to achieve an average spacing of 12" o.c. where 12" spacing o.c. is specified for horizontal bars, as shown in Detail A.4.
- Provide 4 horizontal bars in every three rows of 16" high block to achieve an average spacing of 12" o.c. where 12" spacing o.c. is specified for horizontal bars, as shown in Detail A.5.
- Alternating vertical bar spacing of 8" o.c. and 16" o.c. may be used to achieve an average spacing of 12" o.c. where 12" o.c. spacing is specified for vertical bars, as shown in Detail A.6.

Table A.3. Above Grade Shear Wall Concentrated Vertical Reinforcement for Seismic Zone Classification, $S_{a,ICF} \leq 0.2$ and Hourly Wind Pressure, $q_{1/50} \leq 0.5\text{kPa}$ (in a Building Without Walkout Basement)

Wall Height		Number of Concentrated Vertical 10M Reinforcing Bars at End of Each Shear Wall											
		Seismic Zone Classification											
m	(ft)	$S_{a,ICF} \leq 0.085$				$S_{a,ICF} \leq 0.145$				$S_{a,ICF} \leq 0.2$			
Second Floor Walls of Two Story ICF Structure Supporting Wood Frame Roof													
		Number and length of shear walls provided											
		1 x 8'-0"	2 x 4'-0"	3 x 2'-8"	4 x 2'-0"	1 x 10'-0"	2 x 5'-4"	3 x 3'-6"	4 x 2'-8"	1 x 12'-0"	2 x 7'-0"	3 x 5'-0"	4 x 3'-8"
2.44	(8)	2	2	3	3	2	2	3	3	2	2	2	3
2.75	(9)	2	3	3	3	2	3	3	3	2	3	3	3
3.05	(10)	2	3	4	4	2	4	4	4	2	3	3	4
Main Floor Walls of One Story ICF Structure Supporting Wood Frame Roof													
		Number and length of shear walls provided											
		1 x 8'-0"	2 x 4'-0"	3 x 2'-8"	4 x 2'-0"	1 x 10'-0"	2 x 5'-4"	3 x 3'-6"	4 x 2'-8"	1 x 12'-0"	2 x 7'-0"	3 x 5'-0"	4 x 3'-8"
2.44	(8)	2	2	2	2	2	2	2	3	2	2	2	2
2.75	(9)	2	2	3	3	2	2	3	3	2	2	2	3
3.05	(10)	2	3	3	3	2	3	3	4	2	2	3	3
3.66	(12)	2	3	4		2	4	4	4	2	3	4	4
4.27	(14)	3	4			3	5	5	6	3	4	5	5
4.88	(16)	3	5			3	5	6		3	4	5	6
Main Floor Walls of Two Story Structure Supporting 2nd Story Wood Framed Walls, Floor and Roof													
		Number and length of shear walls provided											
		1 x 10'-0"	2 x 6'-0"	3 x 4'-0"	4 x 3'-0"	1 x 12'-6"	2 x 7'-0"	3 x 5'-0"	4 x 4'-0"	1 x 17'-0"	2 x 10'-0"	3 x 6'-8"	4 x 5'-0"
2.44	(8)	2	2	3	3	2	3	3	3	2	2	3	3
2.75	(9)	2	2	3	3	2	3	4	4	2	2	3	4
3.05	(10)	2	3	4	4	2	4	4	5	2	3	4	5
3.66	(12)	3	3	4	5	3	4	5	5	2	3	4	5
4.27	(14)	3	4	5	6	3	5	6	6	2	4	5	6
4.88	(16)	3	4	5		3	5	6	6	2	4	5	6
Main Floor Walls of Two Story ICF Structure Supporting Wood Frame Floors and Roof													
		Number and length of shear walls provided											
		1 x 12'-0"	2 x 6'-8"	3 x 4'-4"	4 x 3'-4"	1 x 16'-0"	2 x 9'-0"	3 x 6'-4"	4 x 4'-6"	1 x 21'-0"	2 x 12'-4"	3 x 8'-6"	4 x 6'-6"
2.44	(8)	2	3	4	4	2	3	4	5	2	2	3	4
2.75	(9)	2	3	4	5	2	4	4	5	2	3	4	4
3.05	(10)	2	4	4	5	2	4	4	5	2	3	4	4
3.66	(12)	3	4	5	6	2	4	5	6	2	3	4	5
4.27	(14)	3	5	6		3	5	6		2	4	5	6
4.88	(16)	3	5			3	5	6		2	4	5	6
Vertical Reinforcement	6" ICF Tie Spacing	As per table A.1.1.				As per table A.1.1.				As per table A.1.1.			
	8" ICF Tie Spacing	As per table A.1.2.				As per table A.1.2.				As per table A.1.2.			
Horizontal Reinforcement	6" ICF Tie Spacing	10 M @	450	(18)	10 M @	450	(18)	10 M @	450	(18)	10 M @	450	(18)
	8" ICF Tie Spacing	10 M @	400	(16)	10 M @	400	(16)	10 M @	400	(16)	10 M @	400	(16)

NOTES

1. $S_{a,ICF}$ is equivalent spectral response acceleration for ICF walls as provided in Appendix A.
2. This table is to be used in conjunction with the "Design Limitations".
3. Provide two layers of the indicated horizontal and vertical distributed steel specified for 300mm (12") walls. Place each layer as shown in the rebar placement drawing.
4. All four sides of the building are to have a minimum number and length of shear walls that conforms to this table.
5. Use Table A.6 for buildings that do not meet the required wall length of this table.
6. Use the left-most column that meets the minimum number and length of shear walls to determine the minimum required concentrated reinforcement
7. Shaded cells indicate that the minimum bars required beside all windows and openings, as per the "Design Limitations", are adequate.
8. All required number of 10M bars may be replaced by an equivalent number of 15M bars as given in the "Design Limitations"
9. All concentrated reinforcement is to be continues to the bottom of the foundation wall. Provide lap splices as required.
10. Concentrated reinforcement is to be placed in accordance with Bar Placement Detail.

Table A.4 – Above Grade Shear Wall Concentrated Vertical Reinforcement for Seismic Zone Classification, $S_{a,ICF} \leq 0.2$ and Hourly Wind Pressure, $0.5kPa < q_{1/50} \leq 0.75kPa$ (in a Building Without Walkout Basement)

Wall Height		Number of Concentrated Vertical 10M Reinforcing Bars at End of Each Shear Wall											
		Seismic Zone Classification											
m	(ft)	$S_{a,ICF} \leq 0.085$				$S_{a,ICF} \leq 0.145$				$S_{a,ICF} \leq 0.2$			
Second Floor Walls of Two Story ICF Structure Supporting Wood Frame Roof													
		Number and length of shear walls provided											
		1 x 8'-0"	2 x 4'-0"	3 x 2'-8"	4 x 2'-0"	1 x 10'-0"	2 x 5'-0"	3 x 3'-6"	4 x 2'-8"	1 x 11'-0"	2 x 6'-8"	3 x 4'-8"	4 x 3'-6"
2.44	(8)	2	3	3	3	2	3	3	3	2	2	3	3
2.75	(9)	2	3	3	3	2	3	3	4	2	2	3	3
3.05	(10)	2	3	4	4	2	4	4	5	3	3	4	4
Main Floor Walls of One Story ICF Structure Supporting Wood Frame Roof													
		Number and length of shear walls provided											
		1 x 8'-0"	2 x 4'-0"	3 x 2'-8"	4 x 2'-0"	1 x 10'-0"	2 x 5'-0"	3 x 3'-6"	4 x 2'-8"	1 x 11'-0"	2 x 6'-8"	3 x 4'-8"	4 x 3'-6"
2.44	(8)	2	2	3	3	2	2	3	3	2	2	2	3
2.75	(9)	2	2	3	3	2	2	3	4	2	2	2	3
3.05	(10)	2	3	3	4	2	3	4	5	2	3	3	4
3.66	(12)	2	4	4		2	4	4	5	3	3	4	5
4.27	(14)	2	4			2	4	5	5	3	4	5	6
4.88	(16)	2	4			3	5	6		3	4	5	6
Main Floor Walls of Two Story Structure Supporting 2nd Story Wood Framed Walls, Floor and Roof													
		Number and length of shear walls provided											
		1 x 10'-0"	2 x 6'-0"	3 x 4'-0"	4 x 3'-0"	1 x 12'-0"	2 x 6'-8"	3 x 5'-0"	4 x 4'-0"	1 x 16'-0"	2 x 9'-0"	3 x 6'-8"	4 x 5'-0"
2.44	(8)	2	3	3	4	2	4	4	4	2	3	3	4
2.75	(9)	2	3	3	4	2	4	4	4	2	3	3	4
3.05	(10)	2	3	4	4	2	4	4	5	2	3	4	5
3.66	(12)	2	3	4	5	3	5	5	6	2	4	4	6
4.27	(14)	2	4	4	5	3	5	5	6	2	4	4	6
4.88	(16)	2	4	4		3	5	6	6	2	4	4	6
Main Floor Walls of Two Story ICF Structure Supporting Wood Frame Floors and Roof													
		Number and length of shear walls provided											
		1 x 12'-0"	2 x 6'-0"	3 x 4'-4"	4 x 3'-4"	1 x 15'-0"	2 x 9'-0"	3 x 6'-0"	4 x 4'-0"	1 x 20'-0"	2 x 11'-0"	3 x 8'-0"	4 x 6'-4"
2.44	(8)	2	4	4	4	3	3	4	5	2	3	4	4
2.75	(9)	2	4	4	5	3	3	4	6	2	3	4	4
3.05	(10)	2	4	5	5	3	4	5	6	2	3	4	5
3.66	(12)	3	5	6	6	3	5	6		2	4	5	6
4.27	(14)	3	5	6	6	3	5	6		2	5	6	6
4.88	(16)	3	5	6		3	5	6		2	5	6	6
Vertical Reinforcement	6" ICF Tie Spacing	As per table A.1.1.				As per table A.1.1.				As per table A.1.1.			
	8" ICF Tie Spacing	As per table A.1.2.				As per table A.1.2.				As per table A.1.2.			
Horizontal Reinforcement	6" ICF Tie Spacing	10 M @	450	(18)	10 M @	450	(18)	10 M @	450	(18)			
	8" ICF Tie Spacing	10 M @	400	(16)	10 M @	400	(16)	10 M @	400	(16)			

NOTES

- $S_{a,ICF}$ is equivalent spectral response acceleration for ICF walls as provided in Appendix A.
- This table is to be used in conjunction with the "Design Limitations".
- Provide two layers of the indicated horizontal and vertical distributed steel specified for 300mm (12") walls. Place each layer as shown in the rebar placement drawing.
- All four sides of the building are to have a minimum number and length of shear walls that conforms to this table.
- Use Table A.6 for buildings that do not meet the required wall length of this table.
- Use the left-most column that meets the minimum number and length of shear walls to determine the minimum required concentrated reinforcement
- Shaded cells indicate that the minimum bars required beside all windows and openings, as per the "Design Limitations", are adequate.
- All required number of 10M bars may be replaced by an equivalent number of 15M bars as given in the "Design Limitations"
- All concentrated reinforcement is to be continues to the bottom of the foundation wall. Provide lap splices as required.
- Concentrated reinforcement is to be placed in accordance with Bar Placement Detail.

Table A.5 – Above Grade Shear Wall Concentrated Vertical Reinforcement for Seismic Zone Classification, $S_{a,ICF} \leq 0.2$ and Hourly Wind Pressure, $0.75kPa < q_{1/50} \leq 1.05kPa$ (in a Building Without Walkout Basement)

Wall Height		Number of Concentrated Vertical 10M Reinforcing Bars at End of Each Shear Wall											
		Seismic Zone Classification											
m	(ft)	$S_{a,ICF} \leq 0.085$				$S_{a,ICF} \leq 0.145$				$S_{a,ICF} \leq 0.2$			
Second Floor Walls of Two Story ICF Structure Supporting Wood Frame Roof													
		Number and length of shear walls provided											
		1 x 8'-0"	2 x 4'-0"	3 x 2'-8"	4 x 2'-0"	1 x 10'-0"	2 x 5'-4"	3 x 3'-6"	4 x 2'-8"	1 x 12'-0"	2 x 7'-0"	3 x 5'-0"	4 x 3'-8"
2.44	(8)	2	3	4	4	2	3	3	4	2	3	3	4
2.75	(9)	2	3	4	4	2	3	4	4	3	3	4	5
3.05	(10)	2	4	4	5	2	3	4	5	3	3	4	5
Main Floor Walls of One Story ICF Structure Supporting Wood Frame Roof													
		Number and length of shear walls provided											
		1 x 8'-0"	2 x 4'-0"	3 x 2'-8"	4 x 2'-0"	1 x 10'-0"	2 x 5'-4"	3 x 3'-6"	4 x 2'-8"	1 x 12'-0"	2 x 7'-0"	3 x 5'-0"	4 x 3'-8"
2.44	(8)	2	2	3	3	2	2	3	3	2	2	3	3
2.75	(9)	2	3	3	3	2	3	3	4	2	3	3	4
3.05	(10)	2	3	3	4	2	3	4	4	2	3	4	4
3.66	(12)	2	3	4		2	3	4	5	2	3	4	5
4.27	(14)	2	3			2	4	5	5	2	4	4	6
4.88	(16)	2	4			2	4	5		2	4	5	
Main Floor Walls of Two Story Structure Supporting 2nd Story Wood Framed Walls, Floor and Roof													
		Number and length of shear walls provided											
		1 x 10'-0"	2 x 6'-0"	3 x 4'-0"	4 x 3'-0"	1 x 12'-6"	2 x 7'-0"	3 x 5'-0"	4 x 4'-0"	1 x 17'-0"	2 x 10'-0"	3 x 6'-8"	4 x 5'-0"
2.44	(8)	2	3	4	4	2	4	4	5	2	3	4	4
2.75	(9)	2	3	4	4	2	4	5	5	2	3	4	5
3.05	(10)	2	3	4	5	2	4	5	5	2	3	4	5
3.66	(12)	2	3	4	5	2	4	5	6	2	3	4	5
4.27	(14)	2	4	5		2	4	5	6	2	3	5	6
4.88	(16)	2	4	5		2	4	6		2	3	5	6
Main Floor Walls of Two Story ICF Structure Supporting Wood Frame Floors and Roof													
		Number and length of shear walls provided											
		1 x 12'-0"	2 x 6'-8"	3 x 4'-4"	4 x 3'-4"	1 x 16'-0"	2 x 9'-0"	3 x 6'-4"	4 x 4'-6"	1 x 21'-0"	2 x 12'-4"	3 x 8'-6"	4 x 6'-6"
2.44	(8)	2	4	5	5	2	4	5	6	2	4	4	4
2.75	(9)	2	4	5	5	2	5	5	6	2	4	5	5
3.05	(10)	2	4	5	6	2	5	5	6	2	4	5	5
3.66	(12)	2	5	6		2	5	6		2	4	5	5
4.27	(14)	2	5	6		2	5	6		2	4	5	6
4.88	(16)	2	6			2	5	6		2	4	5	6
Vertical Reinforcement	6" ICF Tie Spacing	As per table A.1.1.				As per table A.1.1.				As per table A.1.1.			
	8" ICF Tie Spacing	As per table A.1.2.				As per table A.1.2.				As per table A.1.2.			
Horizontal Reinforcement	6" ICF Tie Spacing	10 M @	450	(18)	10 M @	450	(18)	10 M @	450	(18)	10 M @	450	(18)
	8" ICF Tie Spacing	10 M @	400	(16)	10 M @	400	(16)	10 M @	400	(16)	10 M @	400	(16)

NOTES

- $S_{a,ICF}$ is equivalent spectral response acceleration for ICF walls as provided in Appendix A.
- This table is to be used in conjunction with the "Design Limitations".
- Provide two layers of the indicated horizontal and vertical distributed steel specified for 300mm (12") walls. Place each layer as shown in the rebar placement drawing.
- All four sides of the building are to have a minimum number and length of shear walls that conforms to this table.
- Use Table A.6 for buildings that do not meet the required wall length of this table.
- Use the left-most column that meets the minimum number and length of shear walls to determine the minimum required concentrated reinforcement
- Shaded cells indicate that the minimum bars required beside all windows and openings, as per the "Design Limitations", are adequate.
- All required number of 10M bars may be replaced by an equivalent number of 15M bars as given in the "Design Limitations"
- All concentrated reinforcement is to be continues to the bottom of the foundation wall. Provide lap splices as required.
- Concentrated reinforcement is to be placed in accordance with Bar Placement Detail.

Table A.6 – Above Grade Shear Wall Concentrated Vertical Reinforcement for Seismic Zone Classification, $S_{a,ICF} > 0.2$ and Hourly Wind Pressure, $q_{1/50} \leq 1.05kPa$ (in a Building Without Walkout Basement)

Wall Height		Number of Concentrated Vertical 10M Reinforcing Bars at End of Each Shear Wall															
		Seismic Zone Classification															
m	(ft)	$S_{a,ICF} \leq 0.2$				$S_{a,ICF} \leq 0.4$				$S_{a,ICF} \leq 0.7$				$S_{a,ICF} \leq 1.05$			
Second Floor Walls of Two Story ICF Structure Supporting Wood Frame Roof																	
		Number and length of shear walls provided															
		1 x 10'-0"	2 x 5'-0"	3 x 4'-0"	4 x 3'-0"	1 x 13'-0"	2 x 7'-6"	3 x 5'-6"	4 x 4'-0"	1 x 16'-0"	2 x 9'-0"	3 x 7'-0"	4 x 5'-0"	1 x 18'-0"	2 x 12'-0"	3 x 9'-0"	4 x 7'-0"
2.44	(8)	2	2	3	3	2	2	3	3	2	3	3	4	2	2	3	4
2.75	(9)	2	3	3	4	2	3	4	4	2	3	3	5	2	2	4	4
3.05	(10)	2	4	3	4	3	4	4		2	4	4		3	3	4	6
Main Floor Walls of One Story ICF Structure Supporting Wood Frame Roof																	
		Number and length of shear walls provided															
		1 x 10'-0"	2 x 5'-0"	3 x 4'-0"	4 x 3'-0"	1 x 14'-0"	2 x 8'-0"	3 x 6'-0"	4 x 4'-0"	1 x 17'-0"	2 x 11'-0"	3 x 7'-0"	4 x 5'-0"	1 x 20'-0"	2 x 12'-0"	3 x 9'-0"	4 x 7'-0"
2.44	(8)	2	2	3	3	2	2	3	3	2	2	2	3	2	2	3	4
2.75	(9)	2	3	3	4	2	3	3		2	2	3	4	2	2	4	4
3.05	(10)	2	4	3	4	2	4	4		2	3	4	5	3	3	4	6
3.66	(12)	2	4	4	5	2	4	4		2	4	5		3	3	6	6
4.27	(14)	2	6	5		2	5			4	5			5			
4.88	(16)	2	6			2	5			4	6			6			
Main Floor Walls of Two Story Structure Supporting 2nd Story Wood Framed Walls, Floor and Roof																	
		Number and length of shear walls provided															
		1 x 14'-0"	2 x 8'-0"	3 x 6'-0"	4 x 4'-0"	1 x 16'-0"	2 x 11'-0"	3 x 8'-0"	4 x 6'-0"	1 x 24'-0"	2 x 14'-0"	3 x 10'-0"	4 x 8'-0"	1 x 28'-0"	2 x 16'-0"	3 x 12'-0"	4 x 9'-0"
2.44	(8)	2	2	2	4	2	2	4	4	2	2	3	4	2	2	4	5
2.75	(9)	2	2	3	4	3	3	5	5	2	2	4	5	2	3	4	6
3.05	(10)	2	3	3		3	3	5	5	2	3	4	5	2	4	5	
3.66	(12)	2	3	4		4	4	5		2	4	6		2	6		
4.27	(14)	2	4			6	5			2				4			
4.88	(16)	2	4			6	5			2				4			
Main Floor Walls of Two Story ICF Structure Supporting Wood Frame Floors and Roof																	
		Number and length of shear walls provided															
		1 x 16'-0"	2 x 10'-0"	3 x 7'-0"	4 x 6'-0"	1 x 22'-0"	2 x 14'-0"	3 x 11'-0"	4 x 8'-0"	1 x 28'-0"	2 x 16'-0"	3 x 12'-0"	4 x 9'-4"	1 x 34'-0"	2 x 20'-0"	3 x 15'-0"	4 x 12'-0"
2.44	(8)	2	3	3	3	2	3	3	4	2	2	4	5	2	2	4	5
2.75	(9)	2	3	4	3	2	3	3	5	2	3	4	6	2	3	5	6
3.05	(10)	2	3	4	4	2	4	4	6	2	4	5		2	4	6	
3.66	(12)	2	3	5	5	2	4	4	6	2	6			2	6		
4.27	(14)	2	4	6		3	5	5		5				5			
4.88	(16)	2	4			3	5	5		5				5			
Vertical Reinforcement	6" ICF Tie Spacing	As per table A.2.1.				As per table A.2.1.				As per table A.2.1.				As per table A.2.1.			
	8" ICF Tie Spacing	As per table A.2.2.				As per table A.2.2.				As per table A.2.2.				As per table A.2.2.			
Horizontal Reinforcement	Block Height of 12" and 18"	As per table A.2.1.				As per table A.2.1.				As per table A.2.1.				As per table A.2.1.			
	Block Height of 16"	As per table A.2.2.				As per table A.2.2.				As per table A.2.2.				As per table A.2.2.			

NOTES

- $S_{a,ICF}$ is equivalent spectral response acceleration for ICF walls as provided in Appendix A.
- This table is to be used in conjunction with the "Design Limitations".
- Provide two layers of the indicated horizontal and vertical distributed steel specified for 300mm (12") walls. Place each layer as shown in the rebar placement drawing.
- All four sides of the building are to have a minimum number and length of shear walls that conforms to this table.
- Use the left-most column that meets the minimum number and length of shear walls to determine the minimum required concentrated reinforcement
- Shaded cells indicate that the minimum bars required beside all windows and openings, as per the "Design Limitations", are adequate.
- All required number of 10M bars may be replaced by an equivalent number of 15M bars as given in the "Design Limitations"
- All concentrated reinforcement is to be continues to the bottom of the foundation wall. Provide lap splices as required.
- Concentrated reinforcement is to be placed in accordance with Bar Placement Detail.
- Horizontal reinforcement in shear walls where $S_{a,ICF} > 0.2$ must be anchored using a standard 180° hook around vertical end bars.
- When using this table for $S_{a,ICF} \leq 0.2$, use the vertical and horizontal distributed steel in Tables A.2.1. or A.2.2. for $S_{a,ICF} \leq 0.4$.

Table A.7. Above Grade Shear Wall Concentrated Vertical Reinforcement for Seismic Zone Classification, $S_{a,ICF} \leq 0.2$ and Hourly Wind Pressure, $q_{1/50} \leq 0.5\text{kPa}$ (in a Building With Walkout Basement)

Wall Height		Number of Concentrated Vertical 10M Reinforcing Bars at End of Each Shear Wall											
		Seismic Zone Classification											
m	(ft)	$S_{a,ICF} \leq 0.085$				$S_{a,ICF} \leq 0.145$				$S_{a,ICF} \leq 0.2$			
Second Floor Walls of Two Story ICF Structure Supporting Wood Frame Roof													
		Number and length of shear walls provided											
		1 x 8'-0"	2 x 4'-0"	3 x 2'-8"	4 x 2'-0"	1 x 11'-0"	2 x 6'-0"	3 x 4'-0"	4 x 3'-6"	1 x 14'-0"	2 x 8'-0"	3 x 5'-6"	4 x 4'-4"
2.44	(8)	2	3	3	3	2	2	3	3	2	2	3	3
2.75	(9)	2	3	3	4	2	3	3	4	2	3	3	3
3.05	(10)	2	4	4	5	2	3	4	4	2	3	4	4
Main Floor Walls of One Story ICF Structure Supporting Wood Frame Roof													
		Number and length of shear walls provided											
		1 x 8'-0"	2 x 4'-0"	3 x 2'-8"	4 x 2'-0"	1 x 11'-0"	2 x 6'-0"	3 x 4'-0"	4 x 3'-6"	1 x 14'-0"	2 x 8'-0"	3 x 5'-6"	4 x 4'-4"
2.44	(8)	2	2	3	3	2	2	3	3	2	2	2	2
2.75	(9)	2	3	3	3	2	3	3	3	2	2	3	3
3.05	(10)	2	3	4	4	2	3	4	4	2	2	3	3
3.66	(12)	3	4	5		3	4	5	5	2	4	4	4
4.27	(14)	4	6			4	5	6		3	5	6	6
4.88	(16)	4	6			4	6			4	5		
Main Floor Walls of Two Story Structure Supporting 2nd Story Wood Framed Walls, Floor and Roof													
		Number and length of shear walls provided											
		1 x 10'-0"	2 x 7'-0"	3 x 4'-6"	4 x 3'-4"	1 x 14'-0"	2 x 8'-0"	3 x 6'-4"	4 x 4'-4"	1 x 20'-0"	2 x 11'-0"	3 x 7'-8"	4 x 6'-0"
2.44	(8)	2	2	3	3	2	3	3	4	2	2	3	3
2.75	(9)	3	2	4	4	2	3	3	4	2	3	3	4
3.05	(10)	3	3	4	5	3	4	4	5	2	3	4	5
3.66	(12)	4	3	5	5	4	5	5	6	2	4	5	5
4.27	(14)	5	4	6		4	6	6		2	5	6	6
4.88	(16)	5	4			4	6	6		2	5	6	
Main Floor Walls of Two Story ICF Structure Supporting Wood Frame Floors and Roof													
		Number and length of shear walls provided											
		1 x 12'-0"	2 x 7'-0"	3 x 4'-8"	4 x 3'-8"	1 x 18'-0"	2 x 10'-0"	3 x 7'-8"	4 x 5'-4"	1 x 24'-0"	2 x 13'-0"	3 x 9'-6"	4 x 7'-8"
2.44	(8)	3	3	4	4	2	3	4	4	2	3	3	3
2.75	(9)	3	4	5	5	2	5	4	5	2	3	4	4
3.05	(10)	3	4	5	5	2	5	4	5	2	3	4	4
3.66	(12)	4	5	6	6	2	5	5	6	2	4	5	5
4.27	(14)	5	6			3	6	6		2	5	6	6
4.88	(16)	5	6			3	6	6		2	5	6	
Vertical Reinforcement	6" ICF Tie Spacing	As per table A.1.1.				As per table A.1.1.				As per table A.1.1.			
	8" ICF Tie Spacing	As per table A.1.2.				As per table A.1.2.				As per table A.1.2.			
Horizontal Reinforcement	Block Height of 12" and 18"	10 M @	450	(18)		10 M @	450	(18)		10 M @	450	(18)	
	Block Height of 16"	10 M @	400	(16)		10 M @	400	(16)		10 M @	400	(16)	

NOTES

- $S_{a,ICF}$ is equivalent spectral response acceleration for ICF walls as provided in Appendix A.
- This table is to be used in conjunction with the "Design Limitations".
- Provide two layers of the indicated horizontal and vertical distributed steel specified for 300mm (12") walls. Place each layer as shown in the rebar placement drawing.
- All four sides of the building are to have a minimum number and length of shear walls that conforms to this table.
- Use Table A.10 for buildings that do not meet the required wall length of this table.
- Use the left-most column that meets the minimum number and length of shear walls to determine the minimum required concentrated reinforcement
- Shaded cells indicate that the minimum bars required beside all windows and openings, as per the "Design Limitations", are adequate.
- All required number of 10M bars may be replaced by an equivalent number of 15M bars as given in the "Design Limitations"
- All concentrated reinforcement is to be continues to the bottom of the foundation wall. Provide lap splices as required.
- Concentrated reinforcement is to be placed in accordance with Bar Placement Detail.

Table A.8 – Above Grade Shear Wall Concentrated Vertical Reinforcement for Seismic Zone Classification, $S_{a,ICF} \leq 0.2$ and Hourly Wind Pressure, $0.5kPa < q_{1/50} \leq 0.75kPa$ (in a Building With Walkout Basement)

Wall Height		Number of Concentrated Vertical 10M Reinforcing Bars at End of Each Shear Wall											
		Seismic Zone Classification											
m	(ft)	$S_{a,ICF} \leq 0.085$				$S_{a,ICF} \leq 0.145$				$S_{a,ICF} \leq 0.2$			
Second Floor Walls of Two Story ICF Structure Supporting Wood Frame Roof													
		Number and length of shear walls provided											
		1 x 8'-0"	2 x 4'-0"	3 x 2'-8"	4 x 2'-0"	1 x 10'-6"	2 x 5'-8"	3 x 4'-0"	4 x 3'-4"	1 x 13'-6"	2 x 7'-6"	3 x 5'-0"	4 x 4'-0"
2.44	(8)	2	3	3	4	2	3	3	4	2	2	3	3
2.75	(9)	2	3	4	4	2	3	3	4	2	2	3	4
3.05	(10)	2	4	4	5	2	4	4	5	2	3	4	5
Main Floor Walls of One Story ICF Structure Supporting Wood Frame Roof													
		Number and length of shear walls provided											
		1 x 8'-0"	2 x 4'-0"	3 x 2'-8"	4 x 2'-0"	1 x 10'-6"	2 x 5'-8"	3 x 4'-0"	4 x 3'-0"	1 x 13'-6"	2 x 7'-6"	3 x 5'-0"	4 x 4'-0"
2.44	(8)	2	3	3	3	2	2	3	3	2	2	3	3
2.75	(9)	2	3	3	4	2	3	3	4	2	2	3	3
3.05	(10)	2	4	4	4	2	3	4	5	2	3	4	4
3.66	(12)	3	5	5		3	5	5	5	2	4	5	5
4.27	(14)	3	5			4	5	6		3	5	6	6
4.88	(16)	3	6			4	6			4	5		
Main Floor Walls of Two Story Structure Supporting 2nd Story Wood Framed Walls, Floor and Roof													
		Number and length of shear walls provided											
		1 x 10'-0"	2 x 7'-0"	3 x 4'-6"	4 x 3'-4"	1 x 14'-0"	2 x 7'-8"	3 x 5'-8"	4 x 4'-4"	1 x 17'-6"	2 x 10'-6"	3 x 7'-4"	4 x 5'-8"
2.44	(8)	2	2	3	4	2	4	4	4	2	3	3	4
2.75	(9)	2	2	4	4	2	4	4	4	2	3	3	4
3.05	(10)	3	3	4	5	2	4	5	5	2	3	4	5
3.66	(12)	4	3	5	6	3	5	6	6	2	4	5	6
4.27	(14)	4	4	6		3	6	6		3	4	5	6
4.88	(16)	4	4			3	6			3	4	6	
Main Floor Walls of Two Story ICF Structure Supporting Wood Frame Floors and Roof													
		Number and length of shear walls provided											
		1 x 12'-0"	2 x 7'-0"	3 x 4'-8"	4 x 3'-8"	1 x 17'-0"	2 x 9'-6"	3 x 7'-0"	4 x 5'-4"	1 x 22'-0"	2 x 12'-6"	3 x 9'-0"	4 x 7'-4"
2.44	(8)	3	3	4	4	2	4	4	5	2	3	4	4
2.75	(9)	3	4	4	5	2	4	4	5	2	3	4	4
3.05	(10)	3	4	5	5	2	4	5	6	2	3	4	5
3.66	(12)	4	5	6	6	3	5			2	4	5	6
4.27	(14)	4	5			3	6			2	5	6	6
4.88	(16)	4	5			3	6			2	5	6	6
Vertical Reinforcement	6" ICF Tie Spacing	As per table A.1.1.				As per table A.1.1.				As per table A.1.1.			
	8" ICF Tie Spacing	As per table A.1.2.				As per table A.1.2.				As per table A.1.2.			
Horizontal Reinforcement	Block Height of 12" and 18"	10 M @	450	(18)	10 M @	450	(18)	10 M @	450	(18)	10 M @	450	(18)
	Block Height of 16"	10 M @	400	(16)	10 M @	400	(16)	10 M @	400	(16)	10 M @	400	(16)

NOTES

- $S_{a,ICF}$ is equivalent spectral response acceleration for ICF walls as provided in Appendix A.
- This table is to be used in conjunction with the "Design Limitations".
- Provide two layers of the indicated horizontal and vertical distributed steel specified for 300mm (12") walls. Place each layer as shown in the rebar placement drawing.
- All four sides of the building are to have a minimum number and length of shear walls that conforms to this table.
- Use Table A.10 for buildings that do not meet the required wall length of this table.
- Use the left-most column that meets the minimum number and length of shear walls to determine the minimum required concentrated reinforcement
- Shaded cells indicate that the minimum bars required beside all windows and openings, as per the "Design Limitations", are adequate.
- All required number of 10M bars may be replaced by an equivalent number of 15M bars as given in the "Design Limitations"
- All concentrated reinforcement is to be continues to the bottom of the foundation wall. Provide lap splices as required.
- Concentrated reinforcement is to be placed in accordance with Bar Placement Detail.

Table A.9 – Above Grade Shear Wall Concentrated Vertical Reinforcement for Seismic Zone Classification, $S_{a,ICF} \leq 0.2$ and Hourly Wind Pressure, $0.75kPa < q_{1/50} \leq 1.05kPa$ (in a Building With Walkout Basement)

Wall Height		Number of Concentrated Vertical 10M Reinforcing Bars at End of Each Shear Wall											
		Seismic Zone Classification											
m	(ft)	$S_{a,ICF} \leq 0.085$				$S_{a,ICF} \leq 0.145$				$S_{a,ICF} \leq 0.2$			
Second Floor Walls of Two Story ICF Structure Supporting Wood Frame Roof													
		Number and length of shear walls provided											
		1 x 8'-0"	2 x 4'-0"	3 x 2'-8"	4 x 2'-0"	1 x 10'-0"	2 x 5'-6"	3 x 4'-0"	4 x 3'-4"	1 x 12'-0"	2 x 7'-0"	3 x 4'-6"	4 x 3'-8"
2.44	(8)	2	3	4	4	2	3	3	4	2	3	4	4
2.75	(9)	2	4	4	4	2	4	4	4	2	3	4	5
3.05	(10)	2	4	4	5	2	4	4	5	2	3	4	5
Main Floor Walls of One Story ICF Structure Supporting Wood Frame Roof													
		Number and length of shear walls provided											
		1 x 8'-0"	2 x 4'-0"	3 x 2'-8"	4 x 2'-0"	1 x 10'-0"	2 x 5'-6"	3 x 4'-0"	4 x 3'-0"	1 x 12'-0"	2 x 7'-0"	3 x 4'-6"	4 x 3'-6"
2.44	(8)	2	3	3	3	2	3	3	3	2	2	3	3
2.75	(9)	2	3	4	4	2	3	3	4	2	3	4	4
3.05	(10)	2	3	4	4	2	3	4	4	2	3	4	4
3.66	(12)	2	4	5		2	4	4	5	2	4	5	5
4.27	(14)	2	5			2	5	5	6	2	4	6	
4.88	(16)	2	5			2	6	6		2	5		
Main Floor Walls of Two Story Structure Supporting 2nd Story Wood Framed Walls, Floor and Roof													
		Number and length of shear walls provided											
		1 x 10'-0"	2 x 7'-0"	3 x 4'-6"	4 x 3'-4"	1 x 13'-0"	2 x 7'-4"	3 x 5'-4"	4 x 4'-0"	1 x 15'-0"	2 x 9'-6"	3 x 6'-8"	4 x 5'-4"
2.44	(8)	2	2	3	4	2	4	4	5	2	3	4	4
2.75	(9)	2	2	4	4	2	4	5	5	2	3	4	5
3.05	(10)	2	2	4	4	2	4	5	5	2	3	4	5
3.66	(12)	2	2	4	5	2	4	5	6	2	4	5	5
4.27	(14)	2	2	4		2	5	6		2	4	6	6
4.88	(16)	2	2	5		2	5	6		2	4	6	
Main Floor Walls of Two Story ICF Structure Supporting Wood Frame Floors and Roof													
		Number and length of shear walls provided											
		1 x 12'-0"	2 x 7'-0"	3 x 4'-6"	4 x 3'-6"	1 x 16'-0"	2 x 9'-0"	3 x 6'-6"	4 x 4'-6"	1 x 20'-0"	2 x 12'-0"	3 x 8'-4"	4 x 6'-8"
2.44	(8)	2	4	4	5	2	4	5	5	2	3	4	4
2.75	(9)	2	4	5	5	2	4	5	6	2	3	5	5
3.05	(10)	2	4	5	6	2	4	5		2	3	5	5
3.66	(12)	2	5	6		2	5	6		2	3	5	6
4.27	(14)	2	5			2	5	6		2	3	6	
4.88	(16)	2	6			2	5			2	3	6	
Vertical Reinforcement	6" ICF Tie Spacing	As per table A.1.1.				As per table A.1.1.				As per table A.1.1.			
	8" ICF Tie Spacing	As per table A.1.2.				As per table A.1.2.				As per table A.1.2.			
Horizontal Reinforcement	Block Height of 12" and 18"	10 M @	450	(18)	10 M @	450	(18)	10 M @	450	(18)	10 M @	450	(18)
	Block Height of 16"	10 M @	400	(16)	10 M @	400	(16)	10 M @	400	(16)	10 M @	400	(16)

NOTES

- $S_{a,ICF}$ is equivalent spectral response acceleration for ICF walls as provided in Appendix A.
- This table is to be used in conjunction with the "Design Limitations".
- Provide two layers of the indicated horizontal and vertical distributed steel specified for 300mm (12") walls. Place each layer as shown in the rebar placement drawing.
- All four sides of the building are to have a minimum number and length of shear walls that conforms to this table.
- Use Table A.10 for buildings that do not meet the required wall length of this table.
- Use the left-most column that meets the minimum number and length of shear walls to determine the minimum required concentrated reinforcement
- Shaded cells indicate that the minimum bars required beside all windows and openings, as per the "Design Limitations", are adequate.
- All required number of 10M bars may be replaced by an equivalent number of 15M bars as given in the "Design Limitations"
- All concentrated reinforcement is to be continues to the bottom of the foundation wall. Provide lap splices as required.
- Concentrated reinforcement is to be placed in accordance with Bar Placement Detail.

Table A.10 – Above Grade Shear Wall Concentrated Vertical Reinforcement for Seismic Zone Classification, $S_{a,ICF} > 0.2$ and Hourly Wind Pressure, $q_{1/50} \leq 1.05kPa$ (in a Building With Walkout Basement)

Wall Height		Seismic Zone Classification															
		$S_{a,ICF} \leq 0.2$				$S_{a,ICF} \leq 0.4$				$S_{a,ICF} \leq 0.7$				$S_{a,ICF} \leq 1.05$			
m	(ft)	Second Floor Walls of Two Story ICF Structure Supporting Wood Frame Roof															
		Number and length of shear walls provided															
		1 x 10'-0"	2 x 5'-0"	3 x 4'-0"	4 x 3'-0"	1 x 13'-0"	2 x 7'-6"	3 x 5'-6"	4 x 4'-0"	1 x 16'-0"	2 x 9'-0"	3 x 7'-0"	4 x 5'-0"	1 x 18'-0"	2 x 12'-0"	3 x 9'-0"	4 x 7'-0"
2.44	(8)	2	3	3	3	2	3	4	4	2	3	3	5	2	2	3	4
2.75	(9)	2	4	4	4	3	4	5	5	2	4	5		3	4	4	6
3.05	(10)	2	5	4	5	4	5	6		3	6	6		5	5	6	
		Main Floor Walls of One Story ICF Structure Supporting Wood Frame Roof															
		Number and length of shear walls provided															
		1 x 11'-0"	2 x 6'-0"	3 x 4'-0"	4 x 3'-0"	1 x 16'-0"	2 x 9'-0"	3 x 6'-0"	4 x 4'-0"	1 x 20'-0"	2 x 12'-0"	3 x 8'-0"	4 x 6'-0"	1 x 24'-0"	2 x 13'-0"	3 x 9'-0"	4 x 7'-0"
2.44	(8)	2	2	3	3	2	2	3	4	2	2	2	3	2	2	3	4
2.75	(9)	2	3	3	4	2	3	3		2	2	3	4	2	2	4	4
3.05	(10)	2	4	4	4	2	4	4		2	3	4	5	3	3	5	6
3.66	(12)	2	4	6	6	2	4	6		2	4	6		3	6		
4.27	(14)	3	6			3				4	6			5			
4.88	(16)	4				4				6							
		Main Floor Walls of Two Story Structure Supporting 2nd Story Wood Framed Walls, Floor and Roof															
		Number and length of shear walls provided															
		1 x 14'-0"	2 x 8'-6"	3 x 6'-0"	4 x 4'-0"	1 x 20'-0"	2 x 14'-0"	3 x 9'-0"	4 x 7'-0"	1 x 26'-0"	2 x 15'-0"	3 x 11'-0"	4 x 9'-0"	1 x 30'-0"	2 x 17'-0"	3 x 13'-0"	4 x 10'-0"
2.44	(8)	2	2	3	5	2	2	4	4	2	2	3	4	2	5	6	6
2.75	(9)	2	3	4	5	2	2	5	5	2	3	4	5	2	6	6	
3.05	(10)	2	3	4		3	2	5	5	2	4	5	6	2	6		
3.66	(12)	2	4	6		4	2	6		2	6			4			
4.27	(14)	4	6			6	4			2				5			
4.88	(16)	4	6			6	4			5							
		Main Floor Walls of Two Story ICF Structure Supporting Wood Frame Floors and Roof															
		Number and length of shear walls provided															
		1 x 16'-0"	2 x 10'-4"	3 x 7'-6"	4 x 6'-0"	1 x 23'-0"	2 x 15'-0"	3 x 11'-0"	4 x 9'-0"	1 x 32'-0"	2 x 17'-0"	3 x 13'-0"	4 x 10'-0"	1 x 38'-0"	2 x 22'-0"	3 x 17'-0"	4 x 13'-0"
2.44	(8)	2	3	3	4	2	3	4	4	2	3	4	5	2	4	4	5
2.75	(9)	2	3	4	4	2	3	4	5	2	4	5	6	2	5	5	6
3.05	(10)	3	4	5	5	3	4	5	6	2	5	6		2	5	6	
3.66	(12)	4	5	6	6	4	5	6		2				2			
4.27	(14)	5	6			6				5				5			
4.88	(16)	5	6			6				6				6			
Vertical Reinforcement	6" ICF Tie Spacing	As per table A.2.1.				As per table A.2.1.				As per table A.2.1.				As per table A.2.1.			
	8" ICF Tie Spacing	As per table A.2.2.				As per table A.2.2.				As per table A.2.2.				As per table A.2.2.			
Horizontal Reinforcement	Block Height of 12" and 18"	As per table A.2.1.				As per table A.2.1.				As per table A.2.1.				As per table A.2.1.			
	Block Height of 16"	As per table A.2.2.				As per table A.2.2.				As per table A.2.2.				As per table A.2.2.			

NOTES

- $S_{a,ICF}$ is equivalent spectral response acceleration for ICF walls as provided in Appendix A.
- This table is to be used in conjunction with the "Design Limitations".
- Provide two layers of the indicated horizontal and vertical distributed steel specified for 300mm (12") walls. Place each layer as shown in the rebar placement drawing.
- All four sides of the building are to have a minimum number and length of shear walls that conforms to this table.
- Use the left-most column that meets the minimum number and length of shear walls to determine the minimum required concentrated reinforcement
- Shaded cells indicate that the minimum bars required beside all windows and openings, as per the "Design Limitations", are adequate.
- All required number of 10M bars may be replaced by an equivalent number of 15M bars as given in the "Design Limitations"
- All concentrated reinforcement is to be continues to the bottom of the foundation wall. Provide lap splices as required.
- Concentrated reinforcement is to be placed in accordance with Bar Placement Detail.
- Horizontal reinforcement in shear walls where $S_{a,ICF} > 0.2$ must be anchored using a standard 180° hook around vertical end bars.
- When using this table for $S_{a,ICF} \leq 0.2$, use the vertical and horizontal distributed steel in Tables A.2.1. or A.2.2. for $S_{a,ICF} \leq 0.4$.

Table A.11 – Above Grade Walkout Basement Shear Wall Concentrated Vertical Reinforcement for Seismic Zone Classification, $S_{a,ICF} \leq 0.4$ and Hourly Wind Pressure, $q_{1/50} \leq 1.05kPa$

Wall Height		Seismic Zone Classification											
		$S_{a,ICF} \leq 0.085$			$S_{a,ICF} \leq 0.145$			$S_{a,ICF} \leq 0.2$			$S_{a,ICF} \leq 0.4$		
m	(ft)	Walkout Basement Wall of a Single Story ICF Structure Supporting Wood Framed Roof											
		Number and length of shear walls provided											
		1 x 10'-0"	2 x 6'-0"	3 x 4'-0"	1 x 12'-0"	2 x 8'-0"	3 x 6'-0"	1 x 14'-0"	2 x 9'-0"	3 x 7'-0"	1 x 19'-0"	2 x 13'-0"	3 x 10'-0"
2.44	(8)	2	3	5	2	3	3	2	3	4	2	2	4
2.75	(9)	2	3	6	2	3	4	2	4	4	2	3	5
3.05	(10)	2	3	6	2	3	4	2	5	5	4	4	5
3.66	(12)	2	4		3	4	5	3	6	6	6	6	
		Walkout Basement Walls of a Two Story Wood Framed Structure Supporting Wood Frame Floors and Roof											
		Number and length of shear walls provided											
		1 x 10'-0"	2 x 6'-6"	3 x 5'-0"	1 x 12'-0"	2 x 8'-0"	3 x 6'-0"	1 x 14'-0"	2 x 9'-0"	3 x 7'-0"	1 x 19'-0"	2 x 13'-0"	3 x 10'-0"
2.44	(8)	2	4	4	2	3	4	2	3	4	2	3	4
2.75	(9)	3	4	5	2	4	4	2	4	4	3	4	5
3.05	(10)	4	5	5	2	4	4	2	4	5	4	5	6
3.66	(12)	5	6	6	3	4	5	3	5	6	5	6	6
		Walkout Basement Wall of a Two Story Building with Main Floor ICF Walls Supporting 2nd Story Wood Framed Walls, Floor and Roof											
		Number and length of shear walls provided											
		1 x 12'-0"	2 x 7'-0"	3 x 5'-6"	1 x 14'-0"	2 x 9'-0"	3 x 7'-0"	1 x 16'-0"	2 x 11'-0"	3 x 8'-6"	1 x 22'-0"	2 x 15'-0"	3 x 12'-0"
2.44	(8)	2	3	3	2	4	4	2	3	4	2	4	4
2.75	(9)	2	3	4	2	4	5	2	3	4	4	4	5
3.05	(10)	2	4	4	2	4	5	2	3	4	4	5	5
3.66	(12)	2	4	5	3	5	6	4	4	6	6	6	6
		Walkout Basement Wall of Two Story ICF Structure Supporting Wood Frame Floors and Roof											
		Number and length of shear walls provided											
		1 x 12'-0"	2 x 8'-0"	3 x 6'-0"	1 x 16'-0"	2 x 10'-6"	3 x 8'-0"	1 x 20'-0"	2 x 13'-0"	3 x 9'-6"	1 x 26'-0"	2 x 18'-0"	3 x 14'-0"
2.44	(8)	2	3	4	2	4	5	2	2	4	2	3	4
2.75	(9)	2	4	5	2	4	5	2	3	5	2	3	5
3.05	(10)	2	4	5	2	4	5	2	3	5	3	4	6
3.66	(12)	3	5	6	3	5	6	2	4	6	6	6	6
Vertical Reinforcement	6", 8", 10" Thick Wall	15 M @	300	(12)	15 M @	300	(12)	15 M @	300	(12)	15 M @	300	(12)
	12" Thick Wall	10 M @	300	(12)	10 M @	300	(12)	10 M @	300	(12)	10 M @	300	(12)
Horizontal Reinforcement	Block Height of 12" and 18"	10 M @	450	(18)	10 M @	450	(18)	10 M @	450	(18)	10 M @	450	(18)
	Block Height of 16"	10 M @	400	(16)	10 M @	400	(16)	10 M @	400	(16)	10 M @	400	(16)

NOTES

- $S_{a,ICF}$ is equivalent spectral response acceleration for ICF walls as provided in Appendix A.
- This table is to be used in conjunction with the "Design Limitations".
- Provide two layers of the indicated horizontal and vertical distributed steel specified for 300mm (12") walls. Place each layer as shown in the rebar placement drawing.
- Use the left-most column that meets the minimum number and length of shear walls to determine the minimum required concentrated reinforcement
- Shaded cells indicate that the minimum bars required beside all windows and openings, as per the "Design Limitations", are adequate.
- All required number of 10M bars may be replaced by an equivalent number of 15M bars as given in the "Design Limitations"
- All concentrated reinforcement is to be continues to the bottom of the foundation wall. Provide lap splices as required.
- Concentrated reinforcement is to be placed in accordance with Bar Placement Detail.
- Horizontal reinforcement in shear walls where $S_{a,ICF} > 0.2$ must be anchored using a standard 180° hook around vertical end bars.
- Walkout basement shear walls are to be reviewed and designed by a structural engineer where $S_{a,ICF} > 0.4$.

Lintel Details and Tables

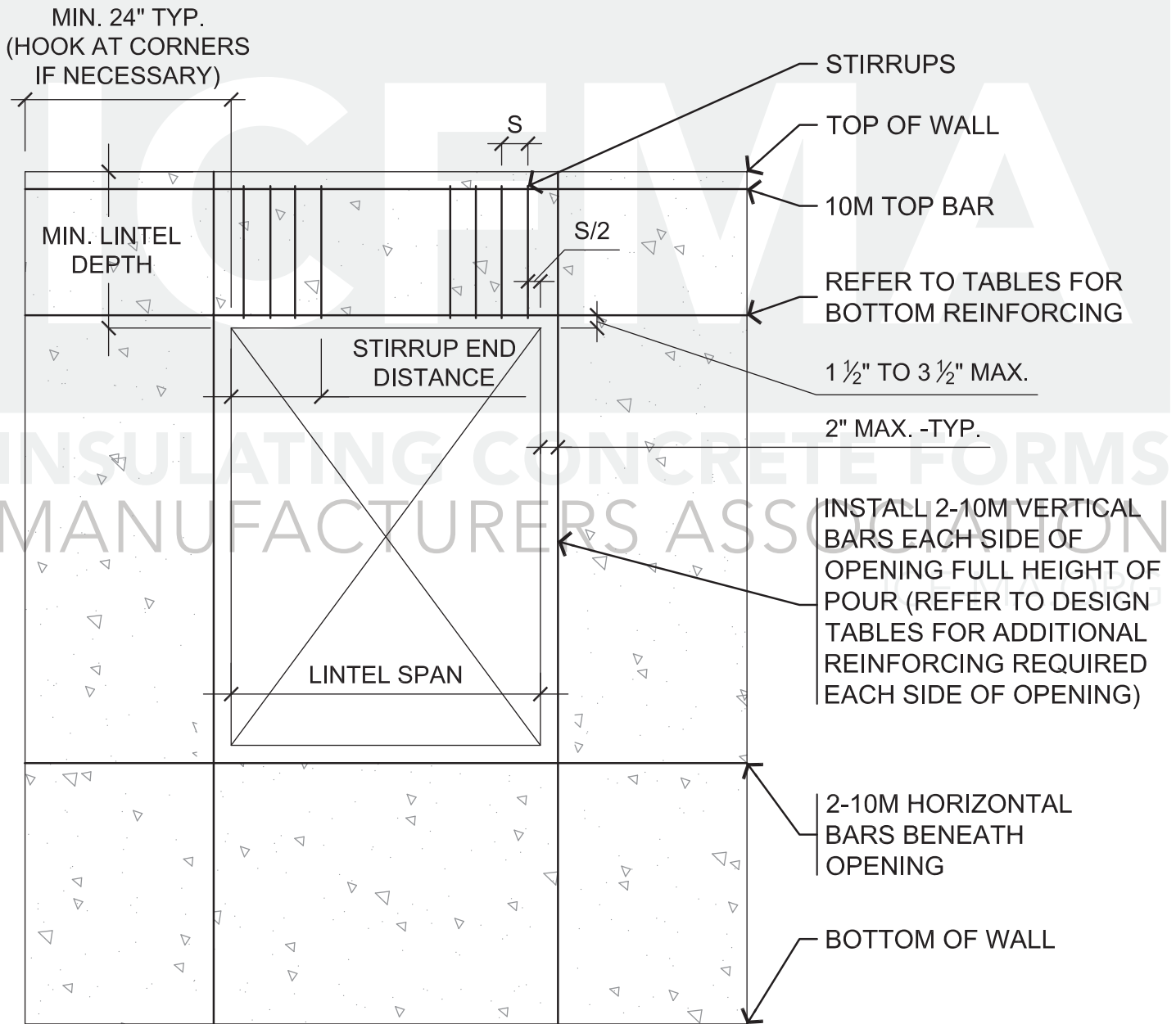

Detail L. 1. Reinforcing Around Openings.

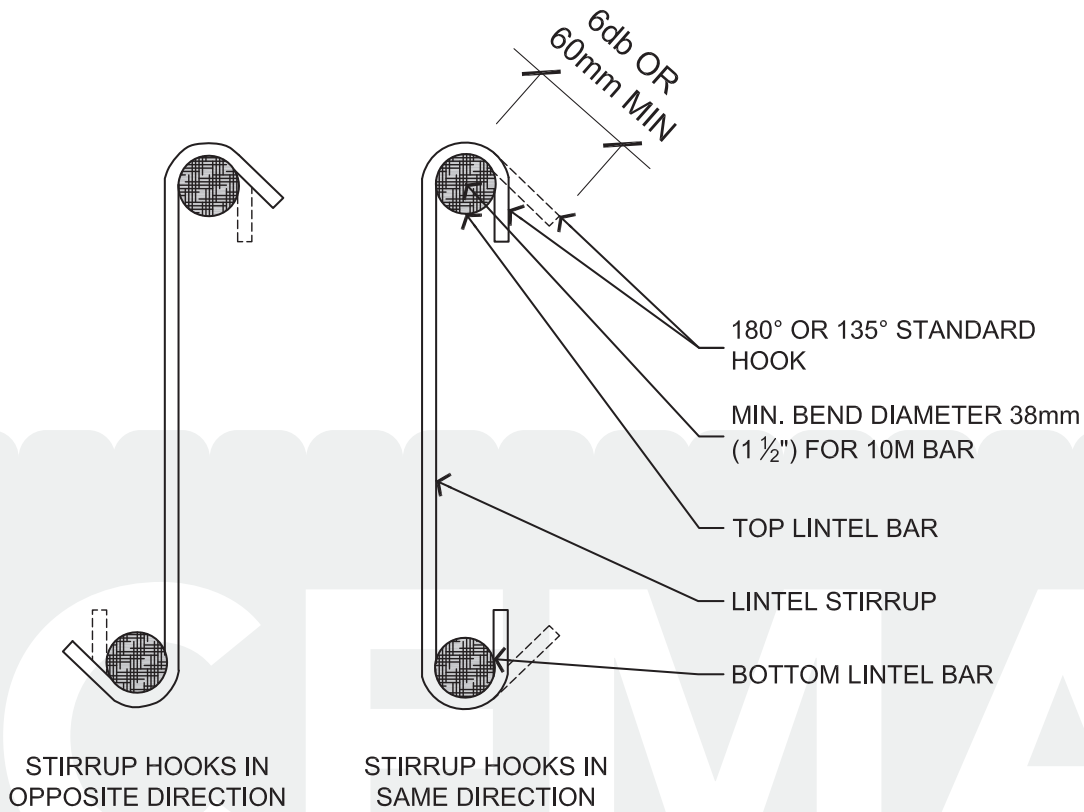

Detail L. 2. Lintel Stirrup Detail.

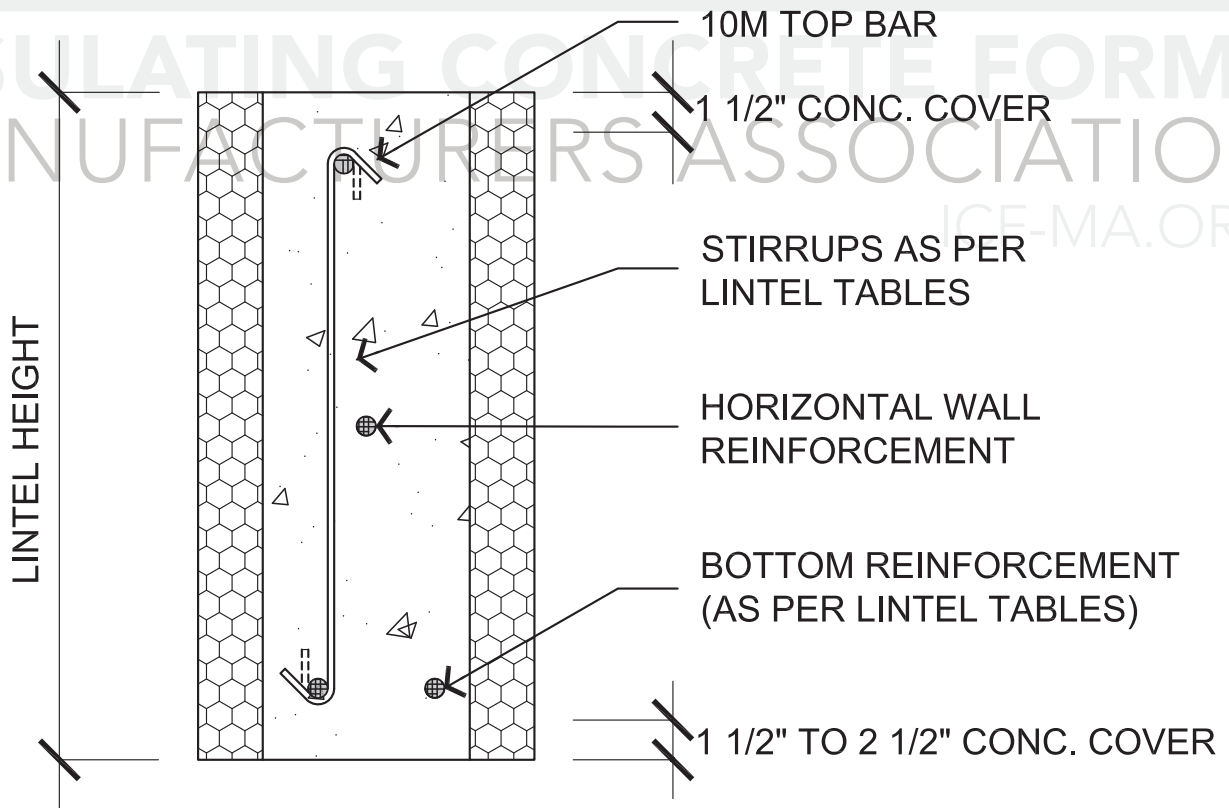

Detail L. 3. Lintel Section

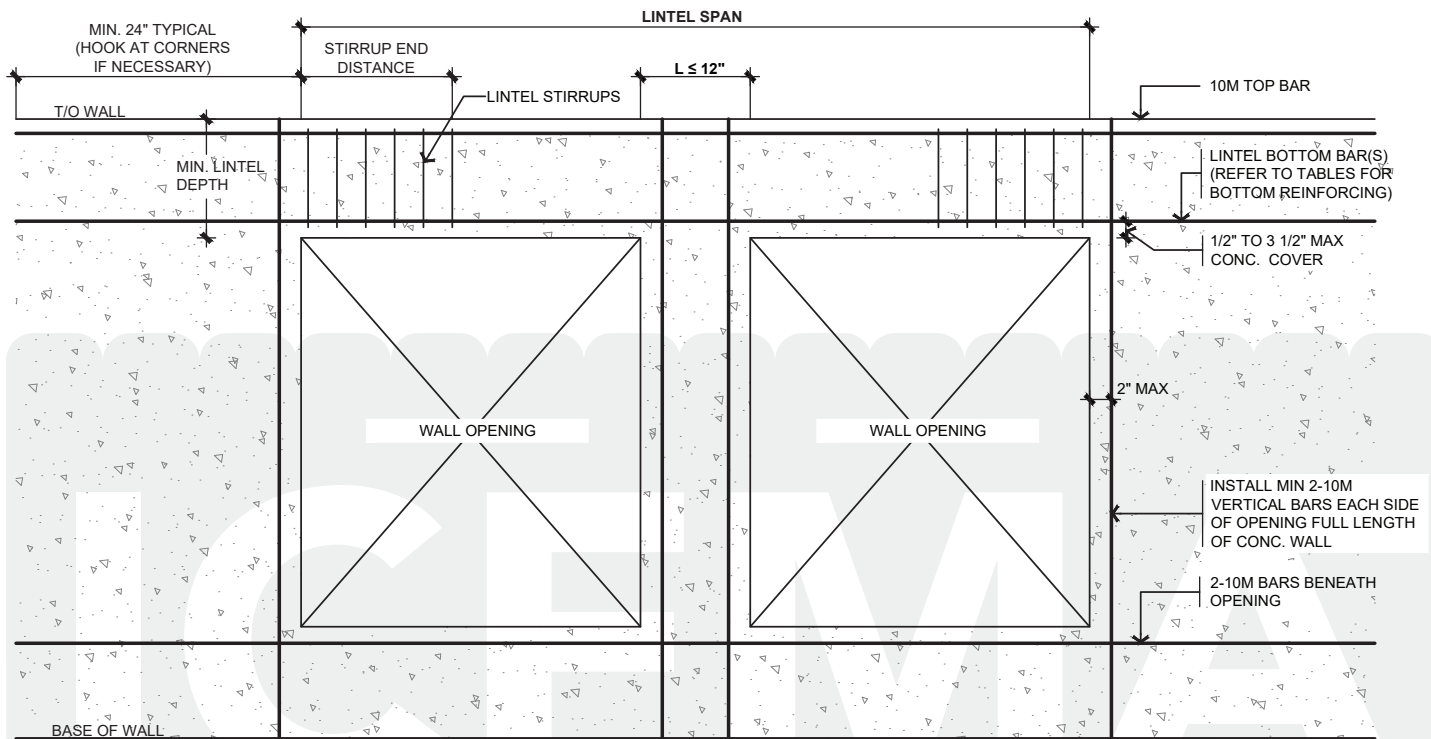

Detail L. 4. Lintel Span with Less Than 305mm (12") of Wall Between Openings.

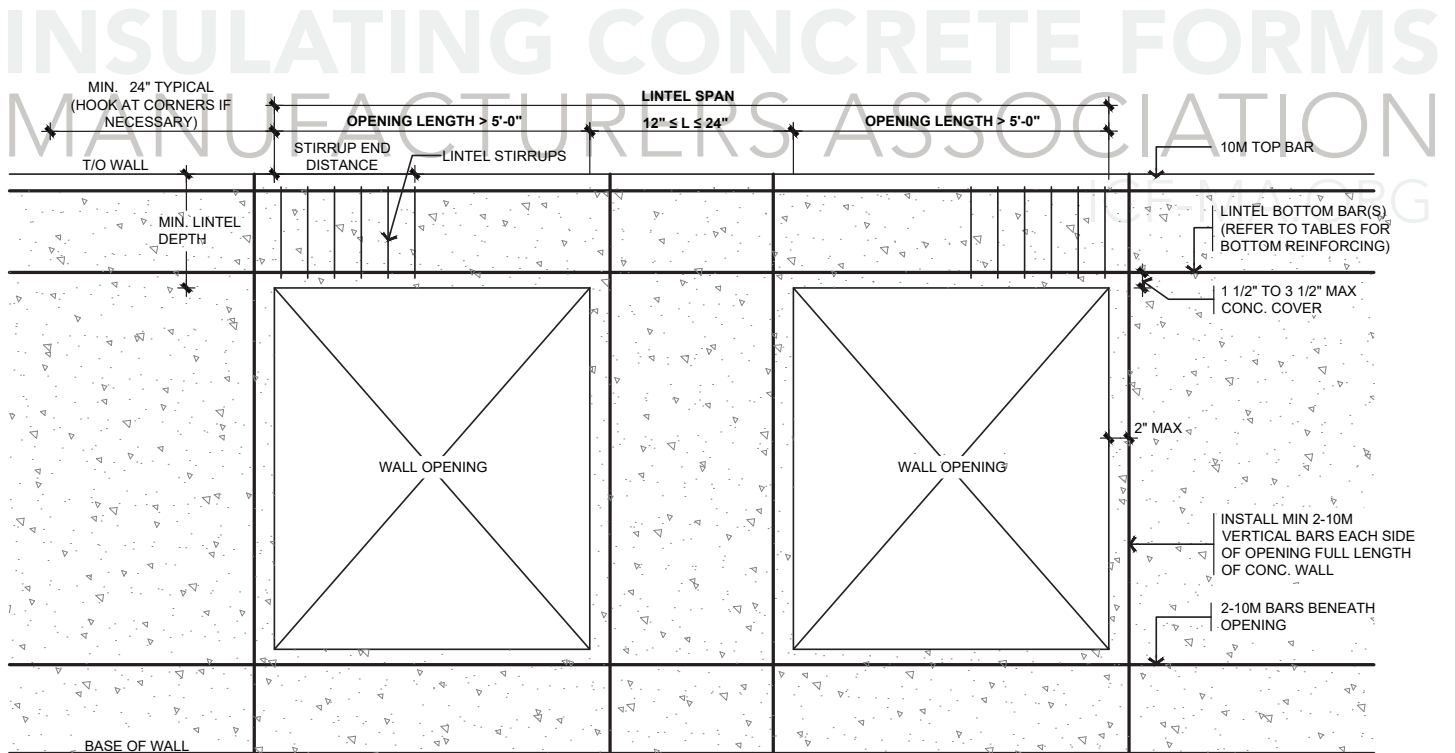

Detail L. 5. Lintel Span with Less Than 610mm (24") of Wall Between Openings, and Openings Are Greater Than 1.53m (5'-0") in Length.

Table L1 6” Lintel Reinforcement with Uniformly Distributed Load

Lintel Span		Lintel - 6” Thick x 8” Deep (150mm Thick x 200mm Deep), s = 3” (75mm)																	
		Uniformly Distributed Load																	
		7.5kN/m		11kN/m		14.5kN/m		18kN/m		21.5kN/m		25.5kN/m		29kN/m		33kN/m		36.5kN/m	
		500lb/ft		750 lb/ft		1000lb/ft		1250lb/ft		1500lb/ft		1750lb/ft		2000lb/ft		2250lb/ft		2500lb/ft	
mm	(ft)	Bottom Reinf. Steel	Stirrup End Distance	Bottom Reinf. Steel	Stirrup End Distance	Bottom Reinf. Steel	Stirrup End Distance	Bottom Reinf. Steel	Stirrup End Distance	Bottom Reinf. Steel	Stirrup End Distance	Bottom Reinf. Steel	Stirrup End Distance	Bottom Reinf. Steel	Stirrup End Distance	Bottom Reinf. Steel	Stirrup End Distance	Bottom Reinf. Steel	Stirrup End Distance
900	(3)	1-10M	0	1-10M	0	1-10M	0	1-10M	150 (6)	1-15M	150 (6)	1-15M	225 (9)	1-15M	225 (9)	1-15M	300 (12)	1-15M	300 (12)
1200	(4)	1-10M	0	1-15M	0	1-15M	150 (6)	1-15M	225 (9)	1-20M	300 (12)	1-20M	375 (15)						
1500	(5)	1-15M	0	1-15M	150 (6)	1-20M	300 (12)												
1800	(6)	1-15M	0	1-20M	300 (12)														
2400	(8)																		
3000	(10)																		
3600	(12)																		
4200	(14)																		
4800	(16)																		
5400	(18)																		
6000	(20)																		

NOTES

1. Stirrup spacing (s) and end distance are given in "mm" and "inch"
2. Do not install more than 1-20M bottom bar or equivalent combination of smaller bars.
3. Bottom reinforcement located 89mm (3.5") from bottom of lintel.
4. This table to be used in conjunction with the "Lintel Design Limitations" & "Lintel Drawing"
5. Cells with zero end distance do not require stirrups, except provide a minimum of three stirrups at each end of the lintel where Sa (0.2) > 0.4.

Lintel Span		Lintel - 6” Thick x 12” Deep (150mm Thick x 300mm Deep), s = 6” (150mm)																	
		Uniformly Distributed Load																	
		7.5kN/m		11kN/m		14.5kN/m		18kN/m		21.5kN/m		25.5kN/m		29kN/m		33kN/m		36.5kN/m	
		500lb/ft		750 lb/ft		1000lb/ft		1250lb/ft		1500lb/ft		1750lb/ft		2000lb/ft		2250lb/ft		2500lb/ft	
mm	(ft)	Bottom Reinf. Steel	Stirrup End Distance	Bottom Reinf. Steel	Stirrup End Distance	Bottom Reinf. Steel	Stirrup End Distance	Bottom Reinf. Steel	Stirrup End Distance	Bottom Reinf. Steel	Stirrup End Distance	Bottom Reinf. Steel	Stirrup End Distance	Bottom Reinf. Steel	Stirrup End Distance	Bottom Reinf. Steel	Stirrup End Distance	Bottom Reinf. Steel	Stirrup End Distance
900	(3)	1-10M	0	1-10M	0	1-10M	0	1-10M	0	1-10M	0	1-10M	300 (12)	1-10M	300 (12)	1-15M	300 (12)	1-15M	300 (12)
1200	(4)	1-10M	0	1-10M	0	1-10M	0	1-15M	0	1-15M	300 (12)	1-15M	300 (12)	1-15M	300 (12)	1-15M	450 (18)	1-15M	450 (18)
1500	(5)	1-10M	0	1-15M	0	1-15M	300 (12)	1-15M	300 (12)	1-15M	450 (18)	1-15M	450 (18)	1-20M	450 (18)	1-20M	600 (24)	1-20M	600 (24)
1800	(6)	1-15M	0	1-15M	0	1-15M	300 (12)	1-15M	450 (18)	1-20M	600 (24)	1-20M	600 (24)	2-15M	600 (24)	2-15M	750 (30)	1-15M + 1-20M	750 (30)
2400	(8)	1-15M	0	1-20M	450 (18)	2-15M	600 (24)	2-15M	750 (30)	1-15M + 1-20M	900 (36)								
3000	(10)	1-20M	450 (18)	2-15M	750 (30)														
3600	(12)	1-15M + 1-20M	750 (30)																
4200	(14)																		
4800	(16)																		
5400	(18)																		
6000	(20)																		

NOTES

1. Stirrup spacing (s) and end distance are given in "mm" and "inch"
2. Do not install more than 2-20M bottom bar or equivalent combination of smaller bars.
3. Bottom reinforcement located 89mm (3.5") from bottom of lintel.
4. This table to be used in conjunction with the "Lintel Design Limitations" & "Lintel Drawing"
5. Cells with zero end distance do not require stirrups, except provide a minimum of three stirrups at each end of the lintel where Sa (0.2) > 0.4.

Table L1 Continued

Lintel Span		Lintel - 6" Thick x 16" Deep (150mm Thick x 400mm Deep), s = 8" (200mm)																	
		Uniformly Distributed Load																	
		7.5kN/m		11kN/m		14.5kN/m		18kN/m		21.5kN/m		25.5kN/m		29kN/m		36.5kN/m		43.5kN/m	
		500lb/ft		750 lb/ft		1000lb/ft		1250lb/ft		1500lb/ft		1750lb/ft		2000lb/ft		2500lb/ft		3000lb/ft	
mm	(ft)	Bottom Reinf. Steel	Stirrup End Distance	Bottom Reinf. Steel	Stirrup End Distance	Bottom Reinf. Steel	Stirrup End Distance	Bottom Reinf. Steel	Stirrup End Distance	Bottom Reinf. Steel	Stirrup End Distance	Bottom Reinf. Steel	Stirrup End Distance	Bottom Reinf. Steel	Stirrup End Distance	Bottom Reinf. Steel	Stirrup End Distance	Bottom Reinf. Steel	Stirrup End Distance
900	(3)	1-10M	0	1-10M	0	1-10M	0	1-10M	0	1-10M	0	1-10M	0	1-10M	0	1-10M	400 (16)	1-10M	400 (16)
1200	(4)	1-10M	0	1-10M	0	1-10M	0	1-10M	0	1-10M	0	1-10M	400 (16)	1-15M	400 (16)	1-15M	400 (16)	1-15M	400 (16)
1500	(5)	1-10M	0	1-10M	0	1-10M	0	1-15M	0	1-15M	400 (16)	1-15M	400 (16)	1-15M	400 (16)	1-15M	600 (24)	1-15M	600 (24)
1800	(6)	1-10M	0	1-15M	0	1-15M	0	1-15M	400 (16)	1-15M	400 (16)	1-15M	600 (24)	1-15M	600 (24)	1-20M	800 (32)	2-20M	800 (32)
2400	(8)	1-15M	0	1-15M	400 (16)	1-15M	400 (16)	1-20M	600 (24)	1-20M	800 (32)	2-15M	800 (32)	2-15M	1000 (40)	1-15M + 1-20M	1000 (40)		
3000	(10)	1-15M	0	1-20M	600 (24)	2-15M	800 (32)	2-15M	1000 (40)	1-15M + 1-20M	1000 (40)	2-20M	1200 (48)	1-10M + 2-20M	1200 (48)				
3600	(12)	1-20M	400 (16)	2-15M	800 (32)	1-15M + 1-20M	1000 (40)	1-10M + 2-20M	1200 (48)	1-15M + 2-20M	1400 (56)								
4200	(14)	2-15M	800 (32)	2-20M	1200 (48)	1-15M + 2-20M	1400 (56)												
4800	(16)	2-20M	1000 (40)	1-15M + 2-20M	1400 (56)														
5400	(18)	1-15M + 2-20M	1400 (56)																
6000	(20)																		

NOTES

1. Stirrup spacing (s) and end distance are given in "mm" and "inch"
2. Do not install more than 3-20M bottom bar or equivalent combination of smaller bars.
3. Bottom reinforcement located 89mm (3.5") from bottom of lintel.
4. This table to be used in conjunction with the "Lintel Design Limitations" & "Lintel Drawing".
5. Cells with zero end distance do not require stirrups, except provide a minimum of three stirrups at each end of the lintel where Sa (0.2) > 0.4.

Lintel Span		Lintel - 6" Thick x 24" Deep (150mm Thick x 600mm Deep), s = 12" (300mm)																	
		Uniformly Distributed Load																	
		7.5kN/m		11kN/m		14.5kN/m		18kN/m		21.5kN/m		29kN/m		36.5kN/m		43.5kN/m		51kN/m	
		500lb/ft		750 lb/ft		1000lb/ft		1250lb/ft		1500lb/ft		2000lb/ft		2500lb/ft		3000lb/ft		3500lb/ft	
mm	(ft)	Bottom Reinf. Steel	Stirrup End Distance	Bottom Reinf. Steel	Stirrup End Distance	Bottom Reinf. Steel	Stirrup End Distance	Bottom Reinf. Steel	Stirrup End Distance	Bottom Reinf. Steel	Stirrup End Distance	Bottom Reinf. Steel	Stirrup End Distance	Bottom Reinf. Steel	Stirrup End Distance	Bottom Reinf. Steel	Stirrup End Distance	Bottom Reinf. Steel	Stirrup End Distance
900	(3)	1-10M	0	1-10M	0	1-10M	0	1-10M	0	1-10M	0	1-10M	0	1-10M	0	1-10M	0	1-10M	300 (12)
1200	(4)	1-10M	0	1-10M	0	1-10M	0	1-10M	0	1-10M	0	1-10M	0	1-10M	600 (24)	1-10M	600 (24)	1-15M	600 (24)
1500	(5)	1-10M	0	1-10M	0	1-10M	0	1-10M	0	1-10M	0	1-15M	600 (24)	1-15M	600 (24)	1-15M	600 (24)	1-15M	600 (24)
1800	(6)	1-10M	0	1-10M	0	1-10M	0	1-15M	0	1-15M	0	1-15M	600 (24)	1-15M	600 (24)	1-15M	600 (24)	1-15M	900 (36)
2400	(8)	1-10M	0	1-15M	0	1-15M	0	1-15M	600 (24)	1-15M	600 (24)	1-20M	900 (36)	1-20M	900 (36)	2-15M	900 (36)	2-15M	1200 (48)
3000	(10)	1-15M	0	1-15M	0	1-15M	600 (24)	1-20M	600 (24)	1-20M	900 (36)	2-15M	1200 (48)	1-15M + 1-20M	1200 (48)	2-20M	1200 (48)		
3600	(12)	1-15M	0	1-20M	600 (24)	1-20M	900 (36)	2-15M	900 (36)	2-15M	1200 (48)	2-20M	1500 (60)	1-10M + 2-20M	1500 (60)				
4200	(14)	1-20M	600 (24)	1-20M	900 (36)	2-15M	1200 (48)	1-15M + 1-20M	1500 (60)	2-20M	1500 (60)	1-15M + 2-20M	1800 (72)						
4800	(16)	1-20M	600 (24)	2-15M	1200 (48)	1-15M + 1-20M	1500 (60)	1-10M + 2-20M	1800 (72)	1-15M + 2-20M	1800 (72)	1-15M + 3-20M	1950 (78)						
5400	(18)	2-15M	900 (36)	2-20M	1500 (60)	1-10M + 2-20M	1800 (72)	3-20M	2100 (84)	1-15M + 3-20M	2100 (84)								
6000	(20)	1-15M + 1-20M	1200 (48)	1-10M + 2-20M	1800 (72)	3-20M	2100 (84)	1-15M + 3-20M	2400 (96)										

NOTES

1. Stirrup spacing (s) and end distance are given in "mm" and "inch"
2. Do not install more than 4-20M bottom bar or equivalent combination of smaller bars.
3. Bottom reinforcement located 89mm (3.5") from bottom of lintel.
4. This table to be used in conjunction with the "Lintel Design Limitations" & "Lintel Drawing".
5. Cells with zero end distance do not require stirrups, except provide a minimum of three stirrups at each end of the lintel where Sa (0.2) > 0.4.

Table L1 Continued

Lintel Span		Lintel - 6" Thick x 32" Deep (150mm Thick x 800mm Deep), s = 18" (450mm)																	
		Uniformly Distributed Load																	
		7.5kN/m		11kN/m		14.5kN/m		18kN/m		21.5kN/m		29kN/m		36.5kN/m		43.5kN/m		51kN/m	
		500v		750 lb/ft		1000lb/ft		1250lb/ft		1500lb/ft		2000lb/ft		2500lb/ft		3000lb/ft		3500lb/ft	
mm	(ft)	Bottom Reinf. Steel	Stirrup End Distance	Bottom Reinf. Steel	Stirrup End Distance	Bottom Reinf. Steel	Stirrup End Distance	Bottom Reinf. Steel	Stirrup End Distance	Bottom Reinf. Steel	Stirrup End Distance	Bottom Reinf. Steel	Stirrup End Distance	Bottom Reinf. Steel	Stirrup End Distance	Bottom Reinf. Steel	Stirrup End Distance	Bottom Reinf. Steel	Stirrup End Distance
900	(3)	1-10M	0	1-10M	0	1-10M	0	1-10M	0	1-10M	0	1-10M	0	1-10M	0	1-10M	0	1-10M	0
1200	(4)	1-10M	0	1-10M	0	1-10M	0	1-10M	0	1-10M	0	1-10M	0	1-10M	0	1-10M	450 (18)	1-10M	450 (18)
1500	(5)	1-10M	0	1-10M	0	1-10M	0	1-10M	0	1-10M	0	1-10M	0	1-10M	450 (18)	1-15M	450 (18)	1-15M	450 (18)
1800	(6)	1-10M	0	1-10M	0	1-10M	0	1-10M	0	1-10M	0	1-15M	900 (36)	1-15M	900 (36)	1-15M	900 (36)	1-15M	900 (36)
2400	(8)	1-10M	0	1-10M	0	1-15M	0	1-15M	0	1-15M	900 (36)	1-20M	900 (36)	1-20M	900 (36)	1-20M	900 (36)	1-20M	900 (36)
3000	(10)	1-15M	0	1-15M	0	1-15M	0	1-20M	900 (36)	1-20M	900 (36)	1-20M	900 (36)	2-15M	1350 (54)	2-15M	1350 (54)	1-15M + 1-20M	1350 (54)
3600	(12)	1-15M	0	1-20M	0	1-20M	900 (36)	1-20M	900 (36)	1-20M	1350 (54)	2-15M	1350 (54)	1-15M + 1-20M	1800 (72)				
4200	(14)	1-20M	0	1-20M	900 (36)	1-20M	900 (36)	2-15M	1350 (54)	2-15M	1350 (54)	1-15M + 1-20M	1800 (72)						
4800	(16)	1-20M	0	1-20M	900 (36)	2-15M	1350 (54)	1-15M + 1-20M	1350 (54)	1-15M + 1-20M	1800 (72)	1-10M + 2-20M	1800 (72)						
5400	(18)	1-20M	900 (36)	2-15M	1350 (54)	1-15M + 1-20M	1800 (72)	2-20M	1800 (72)	1-10M + 2-20M	2250 (90)								
6000	(20)	2-15M	900 (36)	1-15M + 1-20M	1350 (54)	2-20M	1800 (72)	1-10M + 2-20M	2250 (90)	3-20M	2250 (90)								

NOTES

1. Stirrup spacing (s) and end distance are given in "mm" and "inch"
2. Do not install more than 4-20M bottom bar or equivalent combination of smaller bars.
3. Bottom reinforcement located 89mm (3.5") from bottom of lintel.
4. This table to be used in conjunction with the "Lintel Design Limitations" & "Lintel Drawing".
5. Cells with zero end distance do not require stirrups, except provide a minimum of three stirrups at each end of the lintel where Sa (0.2) > 0.4.

INSULATING CONCRETE FORMS
MANUFACTURERS ASSOCIATION
ICF-MA.ORG

Table L2 8” Lintel Reinforcement with Uniformly Distributed Load

Lintel Span		Lintel - 8” Thick x 8” Deep (200mm Thick x 200mm Deep), s = 3” (75mm)																	
		Uniformly Distributed Load																	
		7.5kN/m		11kN/m		14.5kN/m		18kN/m		21.5kN/m		25.5kN/m		29kN/m		33kN/m		36.5kN/m	
		500lb/ft		750 lb/ft		1000lb/ft		1250lb/ft		1500lb/ft		1750lb/ft		2000lb/ft		2250lb/ft		2500lb/ft	
mm	(ft)	Bottom Reinf. Steel	Stirrup End Distance	Bottom Reinf. Steel	Stirrup End Distance	Bottom Reinf. Steel	Stirrup End Distance	Bottom Reinf. Steel	Stirrup End Distance	Bottom Reinf. Steel	Stirrup End Distance	Bottom Reinf. Steel	Stirrup End Distance	Bottom Reinf. Steel	Stirrup End Distance	Bottom Reinf. Steel	Stirrup End Distance	Bottom Reinf. Steel	Stirrup End Distance
900	(3)	1-10M	0	1-10M	0	1-10M	0	1-15M	0	1-15M	0	1-15M	150 (6)	1-15M	150 (6)	1-15M	225 (9)	1-15M	225 (9)
1200	(4)	1-15M	0	1-15M	0	1-15M	0	1-15M	150 (6)	1-15M	150 (6)	1-20M	225 (9)	1-20M	300 (12)				
1500	(5)	1-15M	0	1-15M	0	1-20M	150 (6)	1-20M	225 (9)										
1800	(6)	1-15M	0	1-20M	150 (6)														
2400	(8)																		
3000	(10)																		
3600	(12)																		
4200	(14)																		
4800	(16)																		
5400	(18)																		
6000	(20)																		

NOTES

1. Stirrup spacing (s) and end distance are given in “mm” and “inch”
2. Do not install more than 2-15M bottom bar or equivalent combination of smaller bars.
3. Bottom reinforcement located 89mm (3.5”) from bottom of lintel.
4. This table to be used in conjunction with the “Lintel Design Limitations” & “Lintel Drawing”.
5. Cells with zero end distance do not require stirrups, except provide a minimum of three stirrups at each end of the lintel where Sa (0.2) > 0.4.

Lintel Span		Lintel - 8” Thick x 12” Deep (200mm Thick x 300mm Deep), s = 6” (150mm)																	
		Uniformly Distributed Load																	
		7.5kN/m		11kN/m		14.5kN/m		18kN/m		21.5kN/m		25.5kN/m		29kN/m		33kN/m		36.5kN/m	
		500lb/ft		750 lb/ft		1000lb/ft		1250lb/ft		1500lb/ft		1750lb/ft		2000lb/ft		2250lb/ft		2500lb/ft	
mm	(ft)	Bottom Reinf. Steel	Stirrup End Distance	Bottom Reinf. Steel	Stirrup End Distance	Bottom Reinf. Steel	Stirrup End Distance	Bottom Reinf. Steel	Stirrup End Distance	Bottom Reinf. Steel	Stirrup End Distance	Bottom Reinf. Steel	Stirrup End Distance	Bottom Reinf. Steel	Stirrup End Distance	Bottom Reinf. Steel	Stirrup End Distance	Bottom Reinf. Steel	Stirrup End Distance
900	(3)	1-10M	0	1-10M	0	1-10M	0	1-10M	0	1-10M	0	1-10M	0	1-10M	0	1-15M	0	1-15M	300 (12)
1200	(4)	1-10M	0	1-10M	0	1-10M	0	1-15M	0	1-15M	0	1-15M	300 (12)	1-15M	300 (12)	1-15M	300 (12)	1-15M	300 (12)
1500	(5)	1-10M	0	1-15M	0	1-15M	0	1-15M	0	1-15M	300 (12)	1-15M	300 (12)	1-15M	300 (12)	1-20M	450 (18)	1-20M	450 (18)
1800	(6)	1-15M	0	1-15M	0	1-15M	0	1-15M	300 (12)	1-20M	300 (12)	1-20M	450 (18)	2-15M	600 (24)	2-15M	600 (24)	2-15M	600 (24)
2400	(8)	1-15M	0	1-20M	0	1-20M	450 (18)	2-15M	600 (24)	1-15M + 1-20M	600 (24)	2-20M	750 (30)	1-10M + 2-20M	900 (36)				
3000	(10)	1-20M	0	2-15M	450 (18)	2-20M	750 (30)	1-10M + 2-20M	900 (36)										
3600	(12)	1-15M + 1-20M	300 (12)	1-10M + 2-20M	750 (30)														
4200	(14)	1-10M + 2-20M	600 (24)																
4800	(16)																		
5400	(18)																		
6000	(20)																		

NOTES

1. Stirrup spacing (s) and end distance are given in “mm” and “inch”
2. Do not install more than 1-15M + 2-20M bottom bar or equivalent combination of smaller bars.
3. Bottom reinforcement located 89mm (3.5”) from bottom of lintel.
4. This table to be used in conjunction with the “Lintel Design Limitations” & “Lintel Drawing”.
5. Cells with zero end distance do not require stirrups, except provide a minimum of three stirrups at each end of the lintel where Sa (0.2) > 0.4.

Table L2 Continued

Lintel Span		Lintel - 8" Thick x 16" Deep (200mm Thick x 400mm Deep), s = 8" (200mm)																	
		Uniformly Distributed Load																	
		7.5kN/m		11kN/m		14.5kN/m		18kN/m		21.5kN/m		25.5kN/m		29kN/m		36.5kN/m		43.5kN/m	
		500lb/ft		750 lb/ft		1000lb/ft		1250lb/ft		1500lb/ft		1750lb/ft		2000lb/ft		2500lb/ft		3000lb/ft	
mm	(ft)	Bottom Reinf. Steel	Stirrup End Distance	Bottom Reinf. Steel	Stirrup End Distance	Bottom Reinf. Steel	Stirrup End Distance	Bottom Reinf. Steel	Stirrup End Distance	Bottom Reinf. Steel	Stirrup End Distance	Bottom Reinf. Steel	Stirrup End Distance	Bottom Reinf. Steel	Stirrup End Distance	Bottom Reinf. Steel	Stirrup End Distance	Bottom Reinf. Steel	Stirrup End Distance
900	(3)	1-10M	0	1-10M	0	1-10M	0	1-10M	0	1-10M	0	1-10M	0	1-10M	0	1-10M	0	1-10M	0
1200	(4)	1-10M	0	1-10M	0	1-10M	0	1-10M	0	1-10M	0	1-10M	0	1-15M	0	1-15M	400 (16)	1-15M	400 (16)
1500	(5)	1-10M	0	1-10M	0	1-10M	0	1-15M	0	1-15M	0	1-15M	400 (16)	1-15M	400 (16)	1-15M	400 (16)	1-15M	400 (16)
1800	(6)	1-10M	0	1-15M	0	1-15M	0	1-15M	0	1-15M	400 (16)	1-15M	400 (16)	1-15M	400 (16)	1-20M	600 (24)	1-20M	600 (24)
2400	(8)	1-15M	0	1-15M	0	1-15M	0	1-20M	400 (16)	1-20M	600 (24)	2-15M	600 (24)	2-15M	800 (32)	1-15M + 1-20M	800 (32)	2-20M	1000 (40)
3000	(10)	1-15M	0	1-20M	0	2-15M	400 (16)	2-15M	800 (32)	1-15M + 1-20M	800 (32)	2-20M	1000 (40)	1-10M + 2-20M	1000 (40)	1-10M + 3-20M	1200 (48)	1-10M + 3-20M	1200 (48)
3600	(12)	1-20M	0	2-15M	600 (24)	1-15M + 1-20M	800 (32)	2-20M	1000 (40)	1-10M + 2-20M	1200 (48)	3-20M	1200 (48)	1-10M + 3-20M	1400 (56)				
4200	(14)	2-15M	400 (16)	2-20M	800 (32)	1-10M + 2-20M	1200 (48)	3-20M	1400 (56)										
4800	(16)	2-20M	600 (24)	1-15M + 2-20M	1200 (48)	1-10M + 3-20M	1400 (56)												
5400	(18)	1-10M + 2-20M	1000 (40)	1-10M + 3-20M	1400 (56)														
6000	(20)	3-20M	1200 (48)																

NOTES

1. Stirrup spacing (s) and end distance are given in "mm" and "inch"
2. Do not install more than 4-20M bottom bar or equivalent combination of smaller bars.
3. Bottom reinforcement located 89mm (3.5") from bottom of lintel.
4. This table to be used in conjunction with the "Lintel Design Limitations" & "Lintel Drawing"
5. Cells with zero end distance do not require stirrups, except provide a minimum of three stirrups at each end of the lintel where Sa (0.2) > 0.4.

Lintel Span		Lintel - 8" Thick x 24" Deep (200mm Thick x 600mm Deep), s = 12" (300mm)																	
		Uniformly Distributed Load																	
		7.5kN/m		11kN/m		14.5kN/m		18kN/m		21.5kN/m		29kN/m		36.5kN/m		43.5kN/m		51kN/m	
		500lb/ft		750 lb/ft		1000lb/ft		1250lb/ft		1500lb/ft		2000lb/ft		2500lb/ft		3000lb/ft		3500lb/ft	
mm	(ft)	Bottom Reinf. Steel	Stirrup End Distance	Bottom Reinf. Steel	Stirrup End Distance	Bottom Reinf. Steel	Stirrup End Distance	Bottom Reinf. Steel	Stirrup End Distance	Bottom Reinf. Steel	Stirrup End Distance	Bottom Reinf. Steel	Stirrup End Distance	Bottom Reinf. Steel	Stirrup End Distance	Bottom Reinf. Steel	Stirrup End Distance	Bottom Reinf. Steel	Stirrup End Distance
900	(3)	1-10M	0	1-10M	0	1-10M	0	1-10M	0	1-10M	0	1-10M	0	1-10M	0	1-10M	0	1-10M	0
1200	(4)	1-10M	0	1-10M	0	1-10M	0	1-10M	0	1-10M	0	1-10M	0	1-10M	0	1-10M	0	1-15M	600 (24)
1500	(5)	1-10M	0	1-10M	0	1-10M	0	1-10M	0	1-10M	0	1-15M	0	1-15M	0	1-15M	600 (24)	1-15M	600 (24)
1800	(6)	1-10M	0	1-10M	0	1-10M	0	1-15M	0	1-15M	0	1-15M	0	1-15M	600 (24)	1-20M	600 (24)	1-20M	600 (24)
2400	(8)	1-10M	0	1-15M	0	1-15M	0	1-15M	0	1-20M	600 (24)	1-20M	600 (24)	1-20M	900 (36)	2-15M	900 (36)	2-15M	900 (36)
3000	(10)	1-15M	0	1-20M	0	1-20M	0	1-20M	600 (24)	1-20M	600 (24)	2-15M	900 (36)	1-15M + 1-20M	1200 (48)	1-15M + 1-20M	1200 (48)	2-20M	1200 (48)
3600	(12)	1-20M	0	1-20M	0	1-20M	600 (24)	2-15M	600 (24)	2-15M	900 (36)	1-15M + 1-20M	1200 (48)	1-10M + 2-20M	1500 (60)				
4200	(14)	1-20M	0	2-15M	600 (24)	2-15M	900 (36)	1-15M + 1-20M	900 (36)	2-20M	1200 (48)	1-15M + 2-20M	1500 (60)	1-10M + 3-20M	1800 (72)				
4800	(16)	2-15M	0	2-15M	600 (24)	2-20M	1200 (48)	1-10M + 2-20M	1200 (48)	1-15M + 2-20M	1500 (60)	1-10M + 3-20M	1800 (72)						
5400	(18)	2-15M	600 (24)	2-20M	900 (36)	1-10M + 2-20M	1500 (60)	1-15M + 2-20M	1500 (60)	1-10M + 3-20M	1800 (72)								
6000	(20)	1-15M + 1-20M	600 (24)	1-10M + 2-20M	1200 (48)	3-20M	1800 (72)	1-10M + 3-20M	1800 (72)										

NOTES

1. Stirrup spacing (s) and end distance are given in "mm" and "inch"
2. Do not install more than 4-20M bottom bar or equivalent combination of smaller bars.
3. Bottom reinforcement located 89mm (3.5") from bottom of lintel.
4. This table to be used in conjunction with the "Lintel Design Limitations" & "Lintel Drawing"
5. Cells with zero end distance do not require stirrups, except provide a minimum of three stirrups at each end of the lintel where Sa (0.2) > 0.4.

Table L2 Continued

Lintel Span		Lintel - 8" Thick x 32" Deep (200mm Thick x 800mm Deep), s = 18" (450mm)																	
		Uniformly Distributed Load																	
		7.5kN/m		11kN/m		14.5kN/m		18kN/m		21.5kN/m		29kN/m		36.5kN/m		43.5kN/m		51kN/m	
		500lb/ft		750 lb/ft		1000lb/ft		1250lb/ft		1500lb/ft		2000lb/ft		2500lb/ft		3000lb/ft		3500lb/ft	
mm	(ft)	Bottom Reinf. Steel	Stirrup End Distance	Bottom Reinf. Steel	Stirrup End Distance	Bottom Reinf. Steel	Stirrup End Distance	Bottom Reinf. Steel	Stirrup End Distance	Bottom Reinf. Steel	Stirrup End Distance	Bottom Reinf. Steel	Stirrup End Distance	Bottom Reinf. Steel	Stirrup End Distance	Bottom Reinf. Steel	Stirrup End Distance	Bottom Reinf. Steel	Stirrup End Distance
900	(3)	1-10M	0	1-10M	0	1-10M	0	1-10M	0	1-10M	0	1-10M	0	1-10M	0	1-10M	0	1-10M	0
1200	(4)	1-10M	0	1-10M	0	1-10M	0	1-10M	0	1-10M	0	1-10M	0	1-10M	0	1-10M	0	1-10M	0
1500	(5)	1-10M	0	1-10M	0	1-10M	0	1-10M	0	1-10M	0	1-10M	0	1-10M	0	1-15M	0	1-15M	450 (18)
1800	(6)	1-10M	0	1-10M	0	1-10M	0	1-10M	0	1-10M	0	1-15M	0	1-15M	0	1-15M	900 (36)	1-15M	900 (36)
2400	(8)	1-10M	0	1-10M	0	1-15M	0	1-15M	0	1-15M	0	1-20M	900 (36)	1-20M	900 (36)	2-15M	900 (36)	2-15M	900 (36)
3000	(10)	1-15M	0	1-15M	0	1-15M	0	1-20M	0	1-20M	900 (36)	2-15M	900 (36)	2-15M	900 (36)	2-15M	1350 (54)	2-15M	1350 (54)
3600	(12)	1-15M	0	1-20M	0	1-20M	0	2-15M	900 (36)	2-15M	900 (36)	2-15M	1350 (54)	1-15M + 1-20M	1350 (54)	2-20M	1350 (54)		
4200	(14)	1-20M	0	2-15M	0	2-15M	900 (36)	2-15M	900 (36)	2-15M	900 (36)	1-15M + 1-20M	1350 (54)	1-10M + 2-20M	1800 (72)				
4800	(16)	2-15M	0	2-15M	0	2-15M	900 (36)	1-15M + 1-20M	1350 (54)	2-20M	1350 (54)	1-10M + 2-20M	1800 (72)						
5400	(18)	2-15M	0	2-15M	900 (36)	1-15M + 1-20M	1350 (54)	2-20M	1350 (54)	1-10M + 2-20M	1800 (72)	3-20M	2250 (90)						
6000	(20)	2-15M	0	1-15M + 1-20M	900 (36)	2-20M	1350 (54)	1-10M + 2-20M	1800 (72)	3-20M	1800 (72)								

NOTES

1. Stirrup spacing (s) and end distance are given in "mm" and "inch"
2. Do not install more than 4-20M bottom bar or equivalent combination of smaller bars.
3. Bottom reinforcement located 89mm (3.5") from bottom of lintel.
4. This table to be used in conjunction with the "Lintel Design Limitations" & "Lintel Drawing".
5. Cells with zero end distance do not require stirrups, except provide a minimum of three stirrups at each end of the lintel where Sa (0.2) > 0.4.

INSULATING CONCRETE FORMS
MANUFACTURERS ASSOCIATION
ICF-MA.ORG

Table L3 10” Lintel Reinforcement with Uniformly Distributed Load

Lintel Span		Lintel - 10” Thick x 8” Deep (250mm Thick x 200mm Deep), s = 3” (75mm)																	
		Uniformly Distributed Load																	
		7.5kN/m		11kN/m		14.5kN/m		18kN/m		21.5kN/m		25.5kN/m		29kN/m		33kN/m		36.5kN/m	
		500lb/ft		750 lb/ft		1000lb/ft		1250lb/ft		1500lb/ft		1750lb/ft		2000lb/ft		2250lb/ft		2500lb/ft	
mm	(ft)	Bottom Reinf. Steel	Stirrup End Distance	Bottom Reinf. Steel	Stirrup End Distance	Bottom Reinf. Steel	Stirrup End Distance	Bottom Reinf. Steel	Stirrup End Distance	Bottom Reinf. Steel	Stirrup End Distance	Bottom Reinf. Steel	Stirrup End Distance	Bottom Reinf. Steel	Stirrup End Distance	Bottom Reinf. Steel	Stirrup End Distance	Bottom Reinf. Steel	Stirrup End Distance
900	(3)	1-10M	0	1-10M	0	1-10M	0	1-15M	0	1-15M	0	1-15M	0	1-15M	150 (6)	2-15M	225 (9)	2-15M	225 (9)
1200	(4)	1-15M	0	1-15M	0	1-15M	0	1-15M	0	1-15M	0	1-20M	225 (9)	2-15M	300 (12)				
1500	(5)	1-15M	0	1-15M	0	1-20M	0	1-20M	150 (6)	2-15M	225 (9)								
1800	(6)	1-15M	0	1-20M	0	2-15M	150 (6)												
2400	(8)	2-15M	0																
3000	(10)																		
3600	(12)																		
4200	(14)																		
4800	(16)																		
5400	(18)																		
6000	(20)																		

NOTES

1. Stirrup spacing (s) and end distance are given in “mm” and “inch”
2. Do not install more than 2-15M bottom bar or equivalent combination of smaller bars.
3. Bottom reinforcement located 89mm (3.5”) from bottom of lintel.
4. This table to be used in conjunction with the “Lintel Design Limitations” & “Lintel Drawing”.
5. Cells with zero end distance do not require stirrups, except provide a minimum of three stirrups at each end of the lintel where Sa (0.2) > 0.4.

Lintel Span		Lintel - 10” Thick x 12” Deep (250mm Thick x 300mm Deep), s = 6” (150mm)																	
		Uniformly Distributed Load																	
		7.5kN/m		11kN/m		14.5kN/m		18kN/m		21.5kN/m		25.5kN/m		29kN/m		33kN/m		36.5kN/m	
		500lb/ft		750 lb/ft		1000lb/ft		1250lb/ft		1500lb/ft		1750lb/ft		2000lb/ft		2250lb/ft		2500lb/ft	
mm	(ft)	Bottom Reinf. Steel	Stirrup End Distance	Bottom Reinf. Steel	Stirrup End Distance	Bottom Reinf. Steel	Stirrup End Distance	Bottom Reinf. Steel	Stirrup End Distance	Bottom Reinf. Steel	Stirrup End Distance	Bottom Reinf. Steel	Stirrup End Distance	Bottom Reinf. Steel	Stirrup End Distance	Bottom Reinf. Steel	Stirrup End Distance	Bottom Reinf. Steel	Stirrup End Distance
900	(3)	1-10M	0	1-10M	0	1-10M	0	1-10M	0	1-10M	0	1-10M	0	1-10M	0	1-15M	0	1-15M	0
1200	(4)	1-10M	0	1-10M	0	1-10M	0	1-15M	0	1-15M	0	1-15M	0	1-15M	0	1-15M	300 (12)	1-15M	300 (12)
1500	(5)	1-10M	0	1-15M	0	1-15M	0	1-15M	0	1-15M	0	1-15M	300 (12)	1-15M	300 (12)	1-20M	300 (12)	1-20M	300 (12)
1800	(6)	1-15M	0	1-15M	0	1-15M	0	1-15M	0	1-20M	300 (12)	1-20M	300 (12)	2-15M	450 (18)	2-15M	450 (18)	2-15M	450 (18)
2400	(8)	1-15M	0	1-20M	0	1-20M	0	2-15M	300 (12)	1-15M + 1-20M	450 (18)	2-20M	600 (24)	2-20M	750 (30)	1-10M + 2-20M	750 (30)	1-15M + 2-20M	900 (36)
3000	(10)	1-20M	0	2-15M	0	1-15M + 1-20M	450 (18)	1-10M + 2-20M	600 (24)	1-15M + 2-20M	750 (30)								
3600	(12)	1-15M + 1-20M	0	2-20M	450 (18)	1-15M + 2-20M	750 (30)												
4200	(14)	1-10M + 2-20M	300 (12)	3-20M	750 (30)														
4800	(16)																		
5400	(18)																		
6000	(20)																		

NOTES

1. Stirrup spacing (s) and end distance are given in “mm” and “inch”
2. Do not install more than 3-20M bottom bar or equivalent combination of smaller bars.
3. Bottom reinforcement located 89mm (3.5”) from bottom of lintel.
4. This table to be used in conjunction with the “Lintel Design Limitations” & “Lintel Drawing”.
5. Cells with zero end distance do not require stirrups, except provide a minimum of three stirrups at each end of the lintel where Sa (0.2) > 0.4.

Table L3 Continued

Lintel Span		Lintel - 10" Thick x 16" Deep (250mm Thick x 400mm Deep), s = 8" (200mm)																	
		Uniformly Distributed Load																	
		7.5kN/m		11kN/m		14.5kN/m		18kN/m		21.5kN/m		25.5kN/m		29kN/m		36.5kN/m		43.5kN/m	
		500lb/ft		750 lb/ft		1000lb/ft		1250lb/ft		1500lb/ft		1750lb/ft		2000lb/ft		2500lb/ft		3000lb/ft	
mm	(ft)	Bottom Reinf. Steel	Stirrup End Distance	Bottom Reinf. Steel	Stirrup End Distance	Bottom Reinf. Steel	Stirrup End Distance	Bottom Reinf. Steel	Stirrup End Distance	Bottom Reinf. Steel	Stirrup End Distance	Bottom Reinf. Steel	Stirrup End Distance	Bottom Reinf. Steel	Stirrup End Distance	Bottom Reinf. Steel	Stirrup End Distance	Bottom Reinf. Steel	Stirrup End Distance
900	(3)	1-10M	0	1-10M	0	1-10M	0	1-10M	0	1-10M	0	1-10M	0	1-10M	0	1-10M	0	1-10M	0
1200	(4)	1-10M	0	1-10M	0	1-10M	0	1-10M	0	1-10M	0	1-10M	0	1-15M	0	1-15M	0	1-15M	400 (16)
1500	(5)	1-10M	0	1-10M	0	1-10M	0	1-15M	0	1-15M	0	1-15M	0	1-15M	0	1-20M	400 (16)	1-20M	400 (16)
1800	(6)	1-10M	0	1-15M	0	1-15M	0	1-15M	0	1-20M	0	1-20M	0	1-20M	400 (16)	1-20M	400 (16)	1-20M	600 (24)
2400	(8)	1-15M	0	1-20M	0	1-20M	0	1-20M	0	1-20M	400 (16)	2-15M	400 (16)	2-15M	600 (24)	1-15M + 1-20M	800 (32)	2-20M	800 (32)
3000	(10)	1-20M	0	1-20M	0	2-15M	400 (16)	2-15M	400 (16)	1-15M + 1-20M	600 (24)	2-20M	800 (32)	1-10M + 2-20M	800 (32)	1-15M + 2-20M	1000 (40)	1-10M + 3-20M	1200 (48)
3600	(12)	1-20M	0	2-15M	0	1-15M + 1-20M	600 (24)	2-20M	800 (32)	1-10M + 2-20M	1000 (40)	3-20M	1000 (40)	1-10M + 3-20M	1200 (48)				
4200	(14)	2-15M	0	2-20M	400 (16)	1-10M + 2-20M	800 (32)	3-20M	1000 (40)	1-10M + 3-20M	1200 (48)								
4800	(16)	2-20M	0	1-10M + 2-20M	800 (32)	1-10M + 3-20M	1200 (48)	4-20M	1400 (56)										
5400	(18)	1-10M + 2-20M	400 (16)	1-10M + 3-20M	1000 (40)														
6000	(20)	3-20M	800 (32)																

NOTES

1. Stirrup spacing (s) and end distance are given in "mm" and "inch"
2. Do not install more than 4-20M bottom bar or equivalent combination of smaller bars.
3. Bottom reinforcement located 89mm (3.5") from bottom of lintel.
4. This table to be used in conjunction with the "Lintel Design Limitations" & "Lintel Drawing".
5. Cells with zero end distance do not require stirrups, except provide a minimum of three stirrups at each end of the lintel where Sa (0.2) > 0.4.

Lintel Span		Lintel - 10" Thick x 24" Deep (250mm Thick x 600mm Deep), s = 12" (300mm)																	
		Uniformly Distributed Load																	
		7.5kN/m		11kN/m		14.5kN/m		18kN/m		21.5kN/m		29kN/m		36.5kN/m		43.5kN/m		51kN/m	
		500lb/ft		750 lb/ft		1000lb/ft		1250lb/ft		1500lb/ft		2000lb/ft		2500lb/ft		3000lb/ft		3500lb/ft	
mm	(ft)	Bottom Reinf. Steel	Stirrup End Distance	Bottom Reinf. Steel	Stirrup End Distance	Bottom Reinf. Steel	Stirrup End Distance	Bottom Reinf. Steel	Stirrup End Distance	Bottom Reinf. Steel	Stirrup End Distance	Bottom Reinf. Steel	Stirrup End Distance	Bottom Reinf. Steel	Stirrup End Distance	Bottom Reinf. Steel	Stirrup End Distance	Bottom Reinf. Steel	Stirrup End Distance
900	(3)	1-10M	0	1-10M	0	1-10M	0	1-10M	0	1-10M	0	1-10M	0	1-10M	0	1-10M	0	1-10M	0
1200	(4)	1-10M	0	1-10M	0	1-10M	0	1-10M	0	1-10M	0	1-10M	0	1-10M	0	1-10M	0	1-15M	0
1500	(5)	1-10M	0	1-10M	0	1-10M	0	1-10M	0	1-10M	0	1-15M	0	1-15M	0	1-15M	0	1-15M	600 (24)
1800	(6)	1-10M	0	1-10M	0	1-10M	0	1-15M	0	1-15M	0	1-15M	0	1-15M	0	1-20M	600 (24)	1-20M	600 (24)
2400	(8)	1-15M	0	1-15M	0	1-15M	0	1-15M	0	1-20M	0	1-20M	600 (24)	2-15M	600 (24)	2-15M	600 (24)	2-15M	900 (36)
3000	(10)	1-15M	0	1-20M	0	1-20M	0	2-15M	0	2-15M	600 (24)	2-15M	600 (24)	1-15M + 1-20M	900 (36)	1-15M + 1-20M	900 (36)	2-20M	1200 (48)
3600	(12)	1-20M	0	2-15M	0	2-15M	0	2-15M	600 (24)	2-15M	600 (24)	2-20M	900 (36)	1-10M + 2-20M	1200 (48)	1-15M + 2-20M	1200 (48)		
4200	(14)	2-15M	0	2-15M	0	2-15M	600 (24)	1-15M + 1-20M	600 (24)	2-20M	900 (36)	1-10M + 2-20M	1200 (48)	3-20M	1500 (60)				
4800	(16)	2-15M	0	1-15M + 1-20M	0	2-20M	600 (24)	1-10M + 2-20M	900 (36)	1-15M + 2-20M	1200 (48)	1-10M + 3-20M	1500 (60)						
5400	(18)	1-15M + 1-20M	0	2-20M	600 (24)	1-10M + 2-20M	900 (36)	1-15M + 2-20M	1200 (48)	1-10M + 3-20M	1500 (60)								
6000	(20)	2-20M	0	1-10M + 2-20M	900 (36)	3-20M	1200 (48)	1-15M + 3-20M	1500 (60)										

NOTES

1. Stirrup spacing (s) and end distance are given in "mm" and "inch"
2. Do not install more than 4-20M bottom bar or equivalent combination of smaller bars.
3. Bottom reinforcement located 89mm (3.5") from bottom of lintel.
4. This table to be used in conjunction with the "Lintel Design Limitations" & "Lintel Drawing".
5. Cells with zero end distance do not require stirrups, except provide a minimum of three stirrups at each end of the lintel where Sa (0.2) > 0.4.

Table L3 Continued

Lintel Span		Lintel - 10" Thick x 32" Deep (250mm Thick x 800mm Deep), s = 18" (450mm)																	
		Uniformly Distributed Load																	
		7.5kN/m		11kN/m		14.5kN/m		18kN/m		21.5kN/m		29kN/m		36.5kN/m		43.5kN/m		51kN/m	
		500lb/ft		750 lb/ft		1000lb/ft		1250lb/ft		1500lb/ft		2000lb/ft		2500lb/ft		3000lb/ft		3500lb/ft	
mm	(ft)	Bottom Reinf. Steel	Stirrup End Distance	Bottom Reinf. Steel	Stirrup End Distance	Bottom Reinf. Steel	Stirrup End Distance	Bottom Reinf. Steel	Stirrup End Distance	Bottom Reinf. Steel	Stirrup End Distance	Bottom Reinf. Steel	Stirrup End Distance	Bottom Reinf. Steel	Stirrup End Distance	Bottom Reinf. Steel	Stirrup End Distance	Bottom Reinf. Steel	Stirrup End Distance
900	(3)	1-10M	0	1-10M	0	1-10M	0	1-10M	0	1-10M	0	1-10M	0	1-10M	0	1-10M	0	1-10M	0
1200	(4)	1-10M	0	1-10M	0	1-10M	0	1-10M	0	1-10M	0	1-10M	0	1-10M	0	1-10M	0	1-10M	0
1500	(5)	1-10M	0	1-10M	0	1-10M	0	1-10M	0	1-10M	0	1-10M	0	1-15M	0	1-15M	0	1-15M	0
1800	(6)	1-10M	0	1-10M	0	1-10M	0	1-10M	0	1-10M	0	1-15M	0	1-15M	0	1-15M	0	1-15M	900 (36)
2400	(8)	1-10M	0	1-10M	0	1-15M	0	1-15M	0	1-15M	0	1-20M	0	2-15M	900 (36)	2-15M	900 (36)	2-15M	900 (36)
3000	(10)	1-15M	0	1-15M	0	1-15M	0	1-20M	0	1-20M	0	2-15M	900 (36)	2-15M	900 (36)	2-15M	900 (36)	1-15M + 1-20M	900 (36)
3600	(12)	1-15M	0	1-20M	0	1-20M	0	2-15M	0	2-15M	900 (36)	2-15M	900 (36)	2-20M	900 (36)	2-20M	1350 (54)	1-10M + 2-20M	1350 (54)
4200	(14)	1-20M	0	2-15M	0	2-15M	0	2-15M	900 (36)	2-15M	900 (36)	1-15M + 1-20M	1350 (54)	1-10M + 2-20M	1350 (54)	1-15M + 2-20M	1800 (72)		
4800	(16)	2-15M	0	2-15M	0	2-15M	900 (36)	1-15M + 1-20M	900 (36)	2-20M	900 (36)	1-10M + 2-20M	1350 (54)						
5400	(18)	2-15M	0	2-15M	0	1-15M + 1-20M	900 (36)	2-20M	1350 (54)	1-10M + 2-20M	1350 (54)	3-20M	1800 (72)						
6000	(20)	2-15M	0	1-15M + 1-20M	900 (36)	1-10M + 2-20M	900 (36)	1-15M + 2-20M	1350 (54)	3-20M	1800 (72)	1-15M + 3-20M	2250 (90)						

NOTES

1. Stirrup spacing (s) and end distance are given in "mm" and "inch"
2. Do not install more than 4-20M bottom bar or equivalent combination of smaller bars.
3. Bottom reinforcement located 89mm (3.5") from bottom of lintel.
4. This table to be used in conjunction with the "Lintel Design Limitations" & "Lintel Drawing".
5. Cells with zero end distance do not require stirrups, except provide a minimum of three stirrups at each end of the lintel where Sa (0.2) > 0.4.

INSULATING CONCRETE FORMS
MANUFACTURERS ASSOCIATION
ICF-MA.ORG

Table L4 12” Lintel Reinforcement with Uniformly Distributed Load

Lintel Span		Lintel - 12” Thick x 8” Deep (300mm Thick x 200mm Deep), s = 3” (75mm)																	
		Uniformly Distributed Load																	
		7.5kN/m		11kN/m		14.5kN/m		18kN/m		21.5kN/m		25.5kN/m		29kN/m		33kN/m		36.5kN/m	
		500lb/ft		750 lb/ft		1000lb/ft		1250lb/ft		1500lb/ft		1750lb/ft		2000lb/ft		2250lb/ft		2500lb/ft	
mm	(ft)	Bottom Reinf. Steel	Stirrup End Distance	Bottom Reinf. Steel	Stirrup End Distance	Bottom Reinf. Steel	Stirrup End Distance	Bottom Reinf. Steel	Stirrup End Distance	Bottom Reinf. Steel	Stirrup End Distance	Bottom Reinf. Steel	Stirrup End Distance	Bottom Reinf. Steel	Stirrup End Distance	Bottom Reinf. Steel	Stirrup End Distance	Bottom Reinf. Steel	Stirrup End Distance
900	(3)	1-10M	0	1-10M	0	1-10M	0	1-15M	0	1-15M	0	1-15M	0	1-15M	0	1-15M	0	1-15M	0
1200	(4)	1-15M	0	1-15M	0	1-15M	0	1-15M	0	1-15M	0	1-20M	0	1-20M	150 (6)	2-15M	150 (6)	2-15M	225 (9)
1500	(5)	1-15M	0	1-15M	0	1-20M	0	1-20M	0	2-15M	150 (6)	2-15M	225 (9)	1-15M + 1-20M	225 (9)	2-20M	300 (12)		
1800	(6)	1-15M	0	1-20M	0	2-15M	0	2-15M	150 (6)	2-20M	225 (9)								
2400	(8)	2-15M	0	2-20M	0														
3000	(10)																		
3600	(12)																		
4200	(14)																		
4800	(16)																		
5400	(18)																		
6000	(20)																		

NOTES

1. Stirrup spacing (s) and end distance are given in “mm” and “inch”
2. Do not install more than 2-20M bottom bar or equivalent combination of smaller bars.
3. Bottom reinforcement located 89mm (3.5”) from bottom of lintel.
4. This table to be used in conjunction with the “Lintel Design Limitations” & “Lintel Drawing”.
5. Cells with zero end distance do not require stirrups, except provide a minimum of three stirrups at each end of the lintel where Sa (0.2) > 0.4.

Lintel Span		Lintel - 12” Thick x 12” Deep (300mm Thick x 300mm Deep), s = 6” (150mm)																	
		Uniformly Distributed Load																	
		7.5kN/m		11kN/m		14.5kN/m		18kN/m		21.5kN/m		25.5kN/m		29kN/m		33kN/m		36.5kN/m	
		500lb/ft		750 lb/ft		1000lb/ft		1250lb/ft		1500lb/ft		1750lb/ft		2000lb/ft		2250lb/ft		2500lb/ft	
mm	(ft)	Bottom Reinf. Steel	Stirrup End Distance	Bottom Reinf. Steel	Stirrup End Distance	Bottom Reinf. Steel	Stirrup End Distance	Bottom Reinf. Steel	Stirrup End Distance	Bottom Reinf. Steel	Stirrup End Distance	Bottom Reinf. Steel	Stirrup End Distance	Bottom Reinf. Steel	Stirrup End Distance	Bottom Reinf. Steel	Stirrup End Distance	Bottom Reinf. Steel	Stirrup End Distance
900	(3)	1-10M	0	1-10M	0	1-10M	0	1-10M	0	1-10M	0	1-10M	0	1-10M	0	1-15M	0	1-15M	0
1200	(4)	1-10M	0	1-10M	0	1-10M	0	1-15M	0	1-15M	0	1-15M	0	1-15M	0	1-15M	0	1-20M	0
1500	(5)	1-10M	0	1-15M	0	1-15M	0	1-15M	0	1-15M	0	1-20M	0	1-20M	0	1-20M	300 (12)	1-20M	300 (12)
1800	(6)	1-15M	0	1-15M	0	1-20M	0	1-20M	0	1-20M	0	1-20M	300 (12)	2-15M	300 (12)	2-15M	300 (12)	2-15M	450 (18)
2400	(8)	1-20M	0	1-20M	0	1-20M	0	2-15M	300 (12)	1-15M + 1-20M	300 (12)	1-15M + 1-20M	450 (18)	2-20M	600 (24)	1-10M + 2-20M	600 (24)	1-15M + 2-20M	750 (30)
3000	(10)	1-20M	0	2-15M	0	1-15M + 1-20M	300 (12)	2-20M	450 (18)	1-15M + 2-20M	600 (24)	3-20M	750 (30)	1-10M + 3-20M	900 (36)				
3600	(12)	2-15M	0	2-20M	300 (12)	1-15M + 2-20M	600 (24)	1-10M + 3-20M	750 (30)										
4200	(14)	2-20M	0	3-20M	450 (18)	4-20M	900 (36)												
4800	(16)																		
5400	(18)																		
6000	(20)																		

NOTES

1. Stirrup spacing (s) and end distance are given in “mm” and “inch”
2. Do not install more than 4-20M bottom bar or equivalent combination of smaller bars.
3. Bottom reinforcement located 89mm (3.5”) from bottom of lintel.
4. This table to be used in conjunction with the “Lintel Design Limitations” & “Lintel Drawing”.
5. Cells with zero end distance do not require stirrups, except provide a minimum of three stirrups at each end of the lintel where Sa (0.2) > 0.4.

Table L4 Continued

Lintel Span		Lintel - 12" Thick x 16" Deep (300mm Thick x 400mm Deep), s = 8" (200mm)																	
		Uniformly Distributed Load																	
		7.5kN/m		11kN/m		14.5kN/m		18kN/m		21.5kN/m		25.5kN/m		29kN/m		36.5kN/m		43.5kN/m	
		500lb/ft		750 lb/ft		1000lb/ft		1250lb/ft		1500lb/ft		1750lb/ft		2000lb/ft		2500lb/ft		3000lb/ft	
mm	(ft)	Bottom Reinf. Steel	Stirrup End Distance	Bottom Reinf. Steel	Stirrup End Distance	Bottom Reinf. Steel	Stirrup End Distance	Bottom Reinf. Steel	Stirrup End Distance	Bottom Reinf. Steel	Stirrup End Distance	Bottom Reinf. Steel	Stirrup End Distance	Bottom Reinf. Steel	Stirrup End Distance	Bottom Reinf. Steel	Stirrup End Distance	Bottom Reinf. Steel	Stirrup End Distance
900	(3)	1-10M	0	1-10M	0	1-10M	0	1-10M	0	1-10M	0	1-10M	0	1-10M	0	1-10M	0	1-10M	0
1200	(4)	1-10M	0	1-10M	0	1-10M	0	1-10M	0	1-10M	0	1-10M	0	1-15M	0	1-15M	0	1-15M	0
1500	(5)	1-10M	0	1-10M	0	1-10M	0	1-15M	0	1-15M	0	1-15M	0	1-15M	0	1-20M	0	1-20M	400 (16)
1800	(6)	1-10M	0	1-15M	0	1-15M	0	1-15M	0	1-20M	0	1-20M	0	1-20M	0	1-20M	400 (16)	1-20M	400 (16)
2400	(8)	1-15M	0	1-20M	0	1-20M	0	1-20M	0	1-20M	0	2-15M	400 (16)	2-15M	400 (16)	1-15M + 1-20M	600 (24)	2-20M	800 (32)
3000	(10)	1-20M	0	1-20M	0	2-15M	0	2-15M	400 (16)	1-15M + 1-20M	400 (16)	2-20M	600 (24)	2-20M	800 (32)	1-15M + 2-20M	1000 (40)	1-10M + 3-20M	1000 (40)
3600	(12)	1-20M	0	2-15M	0	1-15M + 1-20M	400 (16)	2-20M	600 (24)	1-10M + 2-20M	800 (32)	1-15M + 2-20M	1000 (40)	1-10M + 3-20M	1000 (40)	4-20M	1200 (48)		
4200	(14)	2-15M	0	2-20M	0	1-10M + 2-20M	600 (24)	1-15M + 2-20M	800 (32)	1-10M + 3-20M	1000 (40)	4-20M	1200 (48)						
4800	(16)	2-20M	0	1-10M + 2-20M	400 (16)	1-10M + 3-20M	800 (32)	4-20M	1200 (48)										
5400	(18)	1-10M + 2-20M	0	1-10M + 3-20M	800 (32)														
6000	(20)	3-20M	400 (16)																

NOTES

1. Stirrup spacing (s) and end distance are given in "mm" and "inch"
2. Do not install more than 4-20M bottom bar or equivalent combination of smaller bars.
3. Bottom reinforcement located 89mm (3.5") from bottom of lintel.
4. This table to be used in conjunction with the "Lintel Design Limitations" & "Lintel Drawing".
5. Cells with zero end distance do not require stirrups, except provide a minimum of three stirrups at each end of the lintel where Sa (0.2) > 0.4.

Lintel Span		Lintel - 12" Thick x 24" Deep (300mm Thick x 600mm Deep), s = 12" (300mm)																	
		Uniformly Distributed Load																	
		7.5kN/m		11kN/m		14.5kN/m		18kN/m		21.5kN/m		29kN/m		36.5kN/m		43.5kN/m		51kN/m	
		500lb/ft		750 lb/ft		1000lb/ft		1250lb/ft		1500lb/ft		2000lb/ft		2500lb/ft		3000lb/ft		3500lb/ft	
mm	(ft)	Bottom Reinf. Steel	Stirrup End Distance	Bottom Reinf. Steel	Stirrup End Distance	Bottom Reinf. Steel	Stirrup End Distance	Bottom Reinf. Steel	Stirrup End Distance	Bottom Reinf. Steel	Stirrup End Distance	Bottom Reinf. Steel	Stirrup End Distance	Bottom Reinf. Steel	Stirrup End Distance	Bottom Reinf. Steel	Stirrup End Distance	Bottom Reinf. Steel	Stirrup End Distance
900	(3)	1-10M	0	1-10M	0	1-10M	0	1-10M	0	1-10M	0	1-10M	0	1-10M	0	1-10M	0	1-10M	0
1200	(4)	1-10M	0	1-10M	0	1-10M	0	1-10M	0	1-10M	0	1-10M	0	1-10M	0	1-10M	0	1-15M	0
1500	(5)	1-10M	0	1-10M	0	1-10M	0	1-10M	0	1-10M	0	1-15M	0	1-15M	0	1-15M	0	1-15M	0
1800	(6)	1-10M	0	1-10M	0	1-10M	0	1-15M	0	1-15M	0	1-15M	0	1-15M	0	1-20M	0	1-20M	600 (24)
2400	(8)	1-15M	0	1-15M	0	1-15M	0	1-15M	0	1-20M	0	1-20M	0	2-15M	600 (24)	2-15M	600 (24)	2-15M	600 (24)
3000	(10)	1-15M	0	1-20M	0	1-20M	0	2-15M	0	2-15M	0	2-15M	600 (24)	1-15M + 1-20M	600 (24)	1-15M + 1-20M	900 (36)	2-20M	900 (36)
3600	(12)	1-20M	0	2-15M	0	2-15M	0	2-15M	0	2-15M	600 (24)	2-20M	900 (36)	1-10M + 2-20M	900 (36)	1-15M + 2-20M	1200 (48)	3-20M	1200 (48)
4200	(14)	2-15M	0	2-15M	0	2-15M	0	1-15M + 1-20M	600 (24)	2-20M	600 (24)	1-10M + 2-20M	1200 (48)	3-20M	1200 (48)	1-15M + 3-20M	1500 (60)		
4800	(16)	2-15M	0	1-15M + 1-20M	0	2-20M	600 (24)	1-10M + 2-20M	600 (24)	1-15M + 2-20M	900 (36)	1-10M + 3-20M	1500 (60)						
5400	(18)	1-15M + 1-20M	0	2-20M	0	1-10M + 2-20M	600 (24)	3-20M	900 (36)	1-10M + 3-20M	1200 (48)								
6000	(20)	2-20M	0	1-10M + 2-20M	600 (24)	3-20M	900 (36)	1-15M + 3-20M	1200 (48)										

NOTES

1. Stirrup spacing (s) and end distance are given in "mm" and "inch"
2. Do not install more than 4-20M bottom bar or equivalent combination of smaller bars.
3. Bottom reinforcement located 89mm (3.5") from bottom of lintel.
4. This table to be used in conjunction with the "Lintel Design Limitations" & "Lintel Drawing".
5. Cells with zero end distance do not require stirrups, except provide a minimum of three stirrups at each end of the lintel where Sa (0.2) > 0.4.

Table L4 Continued

Lintel Span		Lintel - 12" Thick x 32" Deep (300mm Thick x 800mm Deep), s = 18" (450mm)																	
		Uniformly Distributed Load																	
		7.5kN/m		11kN/m		14.5kN/m		18kN/m		21.5kN/m		29kN/m		36.5kN/m		43.5kN/m		51kN/m	
		500lb/ft		750 lb/ft		1000lb/ft		1250lb/ft		1500lb/ft		2000lb/ft		2500lb/ft		3000lb/ft		3500lb/ft	
mm	(ft)	Bottom Reinf. Steel	Stirrup End Distance	Bottom Reinf. Steel	Stirrup End Distance	Bottom Reinf. Steel	Stirrup End Distance	Bottom Reinf. Steel	Stirrup End Distance	Bottom Reinf. Steel	Stirrup End Distance	Bottom Reinf. Steel	Stirrup End Distance	Bottom Reinf. Steel	Stirrup End Distance	Bottom Reinf. Steel	Stirrup End Distance	Bottom Reinf. Steel	Stirrup End Distance
900	(3)	1-10M	0	1-10M	0	1-10M	0	1-10M	0	1-10M	0	1-10M	0	1-10M	0	1-10M	0	1-10M	0
1200	(4)	1-10M	0	1-10M	0	1-10M	0	1-10M	0	1-10M	0	1-10M	0	1-10M	0	1-10M	0	1-10M	0
1500	(5)	1-10M	0	1-10M	0	1-10M	0	1-10M	0	1-10M	0	1-10M	0	1-10M	0	1-15M	0	1-15M	0
1800	(6)	1-10M	0	1-10M	0	1-10M	0	1-10M	0	1-10M	0	1-15M	0	1-15M	0	1-15M	0	1-15M	0
2400	(8)	1-10M	0	1-15M	0	1-15M	0	1-15M	0	1-15M	0	1-20M	0	1-20M	0	2-15M	900 (36)	2-15M	900 (36)
300	(10)	1-15M	0	1-15M	0	1-15M	0	1-20M	0	1-20M	0	2-15M	0	2-15M	900 (36)	1-15M + 1-20M	900 (36)	1-15M + 1-20M	900 (36)
3600	(12)	1-15M	0	1-20M	0	1-20M	0	2-15M	0	2-15M	0	1-15M + 1-20M	900 (36)	1-15M + 1-20M	900 (36)	2-20M	900 (36)	1-10M + 2-20M	1350 (54)
4200	(14)	1-20M	0	2-15M	0	2-15M	0	1-15M + 1-20M	0	1-15M + 1-20M	900 (36)	2-20M	900 (36)	1-10M + 2-20M	1350 (54)	1-10M + 2-20M	1350 (54)		
4800	(16)	2-15M	0	1-15M + 1-20M	0	1-15M + 1-20M	0	1-15M + 1-20M	900 (36)	2-20M	900 (36)	1-10M + 2-20M	1350 (54)	3-20M	1350 (54)				
5400	(18)	1-15M + 1-20M	0	1-15M + 1-20M	0	1-15M + 1-20M	0	2-20M	900 (36)	1-10M + 2-20M	900 (36)	3-20M	1350 (54)	1-15M + 3-20M	1800 (72)				
6000	(20)	1-15M + 1-20M	0	2-20M	0	1-10M + 2-20M	900 (36)	1-15M + 2-20M	900 (36)	3-20M	1350 (54)	1-15M + 3-20M	1800 (72)						

NOTES

1. Stirrup spacing (s) and end distance are given in "mm" and "inch"
2. Do not install more than 4-20M bottom bar or equivalent combination of smaller bars.
3. Bottom reinforcement located 89mm (3.5") from bottom of lintel.
4. This table to be used in conjunction with the "Lintel Design Limitations" & "Lintel Drawing".
5. Cells with zero end distance do not require stirrups, except provide a minimum of three stirrups at each end of the lintel where Sa (0.2) > 0.4.

INSULATING CONCRETE FORMS
MANUFACTURERS ASSOCIATION
ICF-MA.ORG

Table L5 6” Lintel Reinforcement Concentrated Load

Lintel Span		Lintel - 6” Thick x 8” Deep (150mm Thick x 200mm Deep), s = 3” (75mm)																	
		Unfactored Point Load																	
		4kN		6kN		8kN		10kN		12kN		14kN		16kN		18kN		20kN	
		800lb		1300lb		1700lb		2200lb		2600lb		3100lb		3500lb		4000lb		4400lb	
mm	(ft)	Bottom Reinf. Steel	Stirrup End Distance	Bottom Reinf. Steel	Stirrup End Distance	Bottom Reinf. Steel	Stirrup End Distance	Bottom Reinf. Steel	Stirrup End Distance	Bottom Reinf. Steel	Stirrup End Distance	Bottom Reinf. Steel	Stirrup End Distance	Bottom Reinf. Steel	Stirrup End Distance	Bottom Reinf. Steel	Stirrup End Distance	Bottom Reinf. Steel	Stirrup End Distance
900	(3)	1-10M	NO	1-10M	NO	1-10M	YES	1-15M	YES	1-15M	YES	1-15M	YES	1-15M	YES	1-20M	YES	1-20M	YES
1200	(4)	1-10M	NO	1-10M	NO	1-15M	YES	1-15M	YES	1-20M	YES	1-20M	YES						
1500	(5)	1-15M	NO	1-15M	NO	1-20M	YES												
1800	(6)	1-15M	NO																
2400	(8)																		
3000	(10)																		
3600	(12)																		
4200	(14)																		
4800	(16)																		
5400	(18)																		
6000	(20)																		

NOTES

1. Stirrup spacing (s) and end distance are given in “mm” and “inch”
2. Do not install more than 1-20M bottom bar or equivalent combination of smaller bars.
3. Bottom reinforcement located 89mm (3.5”) from bottom of lintel.
4. This table to be used in conjunction with the “Lintel Design Limitations” & “Lintel Drawing”.
5. Beams with “NO Stirrups Required” do not require stirrups, except provide a minimum of three stirrups at each end of the lintel where Sa (0.2) > 0.4.

Lintel Span		Lintel - 6” Thick x 12” Deep (150mm Thick x 300mm Deep), s = 6” (150mm)																	
		Unfactored Point Load																	
		4kN		6.5kN		9kN		11.5kN		14kN		16.5kN		19kN		21.5kN		24kN	
		800lb		1400lb		2000lb		2500lb		3100lb		3700lb		4200lb		4800lb		5300lb	
mm	(ft)	Bottom Reinf. Steel	Stirrup End Distance	Bottom Reinf. Steel	Stirrup End Distance	Bottom Reinf. Steel	Stirrup End Distance	Bottom Reinf. Steel	Stirrup End Distance	Bottom Reinf. Steel	Stirrup End Distance	Bottom Reinf. Steel	Stirrup End Distance	Bottom Reinf. Steel	Stirrup End Distance	Bottom Reinf. Steel	Stirrup End Distance	Bottom Reinf. Steel	Stirrup End Distance
900	(3)	1-10M	NO	1-10M	NO	1-10M	NO	1-10M	YES	1-10M	YES	1-10M	YES	1-15M	YES	1-15M	YES	1-15M	YES
1200	(4)	1-10M	NO	1-10M	NO	1-10M	NO	1-15M	YES	1-15M	YES	1-15M	YES	1-15M	YES	1-15M	YES	1-15M	YES
1500	(5)	1-10M	NO	1-15M	NO	1-15M	NO	1-15M	YES	1-15M	YES	1-15M	YES	1-20M	YES	1-20M	YES	2-15M	YES
1800	(6)	1-15M	NO	1-15M	NO	1-15M	YES	1-15M	YES	1-20M	YES	1-20M	YES	2-15M	YES				
2400	(8)	1-15M	NO	1-15M	NO	2-15M	YES	2-15M	YES	1-15M + 1-20M	YES								
3000	(10)	1-20M	NO	2-15M	NO														
3600	(12)	1-15M + 1-20M	NO																
4200	(14)																		
4800	(16)																		
5400	(18)																		
6000	(20)																		

NOTES

1. Stirrup spacing (s) and end distance are given in “mm” and “inch”
2. Do not install more than 2-20M bottom bar or equivalent combination of smaller bars.
3. Bottom reinforcement located 89mm (3.5”) from bottom of lintel.
4. This table to be used in conjunction with the “Lintel Design Limitations” & “Lintel Drawing”.
5. Beams with “NO Stirrups Required” do not require stirrups, except provide a minimum of three stirrups at each end of the lintel where Sa (0.2) > 0.4.

Table L5 Continued

Lintel Span		Lintel - 6" Thick x 16" Deep (150mm Thick x 400mm Deep), s = 8" (200mm)																	
		Unfactored Point Load																	
		4kN		7kN		10kN		13kN		16kN		19kN		21kN		24kN		27kN	
		800lb		1500lb		2200lb		2900lb		3500lb		4200lb		4700lb		5300lb		6000lb	
mm	(ft)	Bottom Reinf. Steel	Stirrup End Distance	Bottom Reinf. Steel	Stirrup End Distance	Bottom Reinf. Steel	Stirrup End Distance	Bottom Reinf. Steel	Stirrup End Distance	Bottom Reinf. Steel	Stirrup End Distance	Bottom Reinf. Steel	Stirrup End Distance	Bottom Reinf. Steel	Stirrup End Distance	Bottom Reinf. Steel	Stirrup End Distance	Bottom Reinf. Steel	Stirrup End Distance
900	(3)	1-10M	NO	1-10M	NO	1-10M	NO	1-10M	YES	1-10M	YES	1-10M	YES	1-10M	YES	1-15M	YES	1-15M	YES
1200	(4)	1-10M	NO	1-10M	NO	1-10M	NO	1-10M	YES	1-15M	YES	1-15M	YES	1-15M	YES	1-15M	YES	1-15M	YES
1500	(5)	1-10M	NO	1-10M	NO	1-10M	NO	1-15M	YES	1-15M	YES	1-15M	YES	1-15M	YES	1-15M	YES	1-20M	YES
1800	(6)	1-10M	NO	1-15M	NO	1-15M	NO	1-15M	YES	1-15M	YES	1-15M	YES	1-20M	YES	2-15M	YES		
2400	(8)	1-15M	NO	1-15M	NO	1-15M	NO	1-20M	YES	1-20M	YES	2-15M	YES	2-20M	YES				
3000	(10)	1-15M	NO	1-20M	NO	2-15M	YES	2-15M	YES	1-15M + 1-20M	YES								
3600	(12)	1-20M	NO	2-15M	NO	1-15M + 1-20M	YES	1-10M + 2-20M	YES	1-15M + 2-20M	YES								
4200	(14)	2-15M	NO	2-20M	NO	1-15M + 2-20M	YES												
4800	(16)	2-20M	NO	1-15M + 2-20M	NO														
5400	(18)	1-15M + 2-20M	NO																
6000	(20)																		

NOTES

1. Stirrup spacing (s) and end distance are given in "mm" and "inch"
2. Do not install more than 3-20M bottom bar or equivalent combination of smaller bars.
3. Bottom reinforcement located 89mm (3.5") from bottom of lintel.
4. This table to be used in conjunction with the "Lintel Design Limitations" & "Lintel Drawing".
5. Beams with "NO Stirrups Required" do not require stirrups, except provide a minimum of three stirrups at each end of the lintel where Sa (0.2) > 0.4.

Lintel Span		Lintel - 6" Thick x 24" Deep (150mm Thick x 600mm Deep), s = 12" (300mm)																	
		Unfactored Point Load																	
		4kN		8kN		12kN		16kN		20kN		24kN		28kN		32kN		36kN	
		800lb		1700lb		2600lb		3500lb		4400lb		5300lb		6200lb		7100lb		8000lb	
mm	(ft)	Bottom Reinf. Steel	Stirrup End Distance	Bottom Reinf. Steel	Stirrup End Distance	Bottom Reinf. Steel	Stirrup End Distance	Bottom Reinf. Steel	Stirrup End Distance	Bottom Reinf. Steel	Stirrup End Distance	Bottom Reinf. Steel	Stirrup End Distance	Bottom Reinf. Steel	Stirrup End Distance	Bottom Reinf. Steel	Stirrup End Distance	Bottom Reinf. Steel	Stirrup End Distance
900	(3)	1-10M	NO	1-10M	NO	1-10M	NO	1-10M	NO	1-10M	YES	1-10M	YES	1-10M	YES	1-10M	YES	1-15M	YES
1200	(4)	1-10M	NO	1-10M	NO	1-10M	NO	1-10M	NO	1-10M	YES	1-10M	YES	1-15M	YES	1-15M	YES	1-15M	YES
1500	(5)	1-10M	NO	1-10M	NO	1-10M	NO	1-10M	YES	1-15M	YES	1-15M	YES	1-15M	YES	1-15M	YES	1-15M	YES
1800	(6)	1-10M	NO	1-10M	NO	1-10M	NO	1-15M	YES	1-15M	YES	1-15M	YES	1-15M	YES	1-15M	YES	1-20M	YES
2400	(8)	1-10M	NO	1-15M	NO	1-15M	NO	1-15M	YES	1-15M	YES	1-15M	YES	1-20M	YES	2-15M	YES	2-15M	YES
3000	(10)	1-15M	NO	1-15M	NO	1-15M	NO	1-20M	YES	1-20M	YES	2-15M	YES	1-15M + 1-20M	YES	2-20M	YES		
3600	(12)	1-15M	NO	1-15M	NO	1-20M	NO	2-15M	YES	2-15M	YES	2-20M	YES	1-10M + 2-20M	YES				
4200	(14)	1-20M	NO	1-20M	NO	2-15M	YES	1-15M + 1-20M	YES	2-20M	YES	1-15M + 2-20M	YES						
4800	(16)	1-20M	NO	2-15M	NO	1-15M + 1-20M	YES	1-10M + 2-20M	YES	1-15M + 2-20M	YES	1-15M + 3-20M	YES						
5400	(18)	2-15M	NO	2-20M	NO	1-10M + 2-20M	YES	3-20M	YES	1-15M + 3-20M	YES								
6000	(20)	1-15M + 1-20M	NO	1-10M + 2-20M	NO	3-20M	YES	1-15M + 3-20M	YES										

NOTES

1. Stirrup spacing (s) and end distance are given in "mm" and "inch"
2. Do not install more than 4-20M bottom bar or equivalent combination of smaller bars.
3. Bottom reinforcement located 89mm (3.5") from bottom of lintel.
4. This table to be used in conjunction with the "Lintel Design Limitations" & "Lintel Drawing".
5. Beams with "NO Stirrups Required" do not require stirrups, except provide a minimum of three stirrups at each end of the lintel where Sa (0.2) > 0.4.

Table L5 Continued

Lintel Span		Lintel - 6" Thick x 32" Deep (150mm Thick x 800mm Deep), s = 18" (450mm)																	
		Unfactored Point Load																	
		4kN/m		9kN/m		14kN/m		19kN/m		24kN/m		29kN/m		34kN/m		39kN/m		44kN/m	
mm	(ft)	Bottom Reinf. Steel	Stirrup End Distance	Bottom Reinf. Steel	Stirrup End Distance	Bottom Reinf. Steel	Stirrup End Distance	Bottom Reinf. Steel	Stirrup End Distance	Bottom Reinf. Steel	Stirrup End Distance	Bottom Reinf. Steel	Stirrup End Distance	Bottom Reinf. Steel	Stirrup End Distance	Bottom Reinf. Steel	Stirrup End Distance	Bottom Reinf. Steel	Stirrup End Distance
		800lb/ft		2000lb/ft		3100lb/ft		4200lb/ft		5300lb/ft		6500lb/ft		7600lb/ft		8700lb/ft		9800lb/ft	
900	(3)	1-10M	NO	1-10M	NO	1-10M	NO	1-10M	NO	1-10M	YES	1-10M	YES	1-10M	YES	1-10M	YES	1-10M	YES
1200	(4)	1-10M	NO	1-10M	NO	1-10M	NO	1-10M	NO	1-10M	YES	1-10M	YES	1-10M	YES	1-15M	YES	1-15M	YES
1500	(5)	1-10M	NO	1-10M	NO	1-10M	NO	1-10M	NO	1-10M	YES	1-15M	YES	1-15M	YES	1-15M	YES	1-15M	YES
1800	(6)	1-10M	NO	1-10M	NO	1-10M	NO	1-10M	YES	1-15M	YES	1-15M	YES	1-15M	YES	1-15M	YES	1-20M	YES
2400	(8)	1-10M	NO	1-10M	NO	1-15M	NO	1-15M	YES	1-15M	YES	1-20M	YES	1-20M	YES	1-20M	YES	1-15M + 1-20M	YES
3000	(10)	1-15M	NO	1-15M	NO	1-15M	NO	1-20M	YES	1-20M	YES	1-20M	YES	2-15M	YES				
3600	(12)	1-15M	NO	1-20M	NO	1-20M	NO	1-20M	YES	2-15M	YES	1-15M + 1-20M	YES						
4200	(14)	1-20M	NO	1-20M	NO	1-20M	NO	2-15M	YES	1-15M + 1-20M	YES								
4800	(16)	1-20M	NO	1-20M	NO	2-15M	YES	1-15M + 1-20M	YES	1-10M + 2-20M	YES								
5400	(18)	1-20M	NO	2-15M	NO	1-15M + 1-20M	YES	2-20M	YES										
6000	(20)	2-15M	NO	1-15M + 1-20M	NO	2-20M	YES	1-10M + 2-20M	YES										

NOTES

1. Stirrup spacing (s) and end distance are given in "mm" and "inch"
2. Do not install more than 4-20M bottom bar or equivalent combination of smaller bars.
3. Bottom reinforcement located 89mm (3.5") from bottom of lintel.
4. This table to be used in conjunction with the "Lintel Design Limitations" & "Lintel Drawing".
5. Beams with "NO Stirrups Required" do not require stirrups, except provide a minimum of three stirrups at each end of the lintel where Sa (0.2) > 0.4.

INSULATING CONCRETE FORMS
MANUFACTURERS ASSOCIATION
ICF-MA.ORG

Table L6 8” Lintel Reinforcement Concentrated Load

Lintel Span		Lintel - 8” Thick x 8” Deep (200mm Thick x 200mm Deep), s = 3” (75mm)																	
		Unfactored Point Load																	
		4kN		6kN		8kN		10kN		12kN		14kN		16kN		18kN		20kN	
		800lb		1300lb		1700lb		2200lb		2600lb		3100lb		3500lb		4000lb		4400lb	
mm	(ft)	Bottom Reinf. Steel	Stirrup End Distance	Bottom Reinf. Steel	Stirrup End Distance	Bottom Reinf. Steel	Stirrup End Distance	Bottom Reinf. Steel	Stirrup End Distance	Bottom Reinf. Steel	Stirrup End Distance	Bottom Reinf. Steel	Stirrup End Distance	Bottom Reinf. Steel	Stirrup End Distance	Bottom Reinf. Steel	Stirrup End Distance	Bottom Reinf. Steel	Stirrup End Distance
900	(3)	1-10M	NO	1-10M	NO	1-10M	NO	1-15M	YES	1-15M	YES	1-15M	YES	1-15M	YES	1-20M	YES	1-20M	YES
1200	(4)	1-15M	NO	1-15M	NO	1-15M	NO	1-15M	YES	1-20M	YES	1-20M	YES						
1500	(5)	1-15M	NO	1-15M	NO	1-20M	NO	1-20M	YES										
1800	(6)	1-15M	NO	1-20M	NO														
2400	(8)																		
3000	(10)																		
3600	(12)																		
4200	(14)																		
4800	(16)																		
5400	(18)																		
6000	(20)																		

NOTES

1. Stirrup spacing (s) and end distance are given in “mm” and “inch”
2. Do not install more than 2-15M bottom bar or equivalent combination of smaller bars.
3. Bottom reinforcement located 89mm (3.5”) from bottom of lintel.
4. This table to be used in conjunction with the “Lintel Design Limitations” & “Lintel Drawing”.
5. Beams with “NO Stirrups Required” do not require stirrups, except provide a minimum of three stirrups at each end of the lintel where Sa (0.2) > 0.4.

Lintel Span		Lintel - 8” Thick x 12” Deep (200mm Thick x 300mm Deep), s = 6” (150mm)																	
		Unfactored Point Load																	
		4kN		6.5kN		9kN		11.5kN		14kN		16.5kN		19kN		21.5kN		24kN	
		800lb		1400lb		2000lb		2500lb		3100lb		3700lb		4200lb		4800lb		5300lb	
mm	(ft)	Bottom Reinf. Steel	Stirrup End Distance	Bottom Reinf. Steel	Stirrup End Distance	Bottom Reinf. Steel	Stirrup End Distance	Bottom Reinf. Steel	Stirrup End Distance	Bottom Reinf. Steel	Stirrup End Distance	Bottom Reinf. Steel	Stirrup End Distance	Bottom Reinf. Steel	Stirrup End Distance	Bottom Reinf. Steel	Stirrup End Distance	Bottom Reinf. Steel	Stirrup End Distance
900	(3)	1-10M	NO	1-10M	NO	1-10M	NO	1-10M	NO	1-15M	NO	1-15M	YES	1-15M	YES	1-15M	YES	1-15M	YES
1200	(4)	1-10M	NO	1-10M	NO	1-10M	NO	1-15M	NO	1-15M	YES	1-15M	YES	1-15M	YES	1-15M	YES	1-15M	YES
1500	(5)	1-10M	NO	1-10M	NO	1-15M	NO	1-15M	NO	1-15M	YES	1-15M	YES	1-20M	YES	1-20M	YES	1-15M + 1-20M	YES
1800	(6)	1-15M	NO	1-15M	NO	1-15M	NO	1-15M	NO	1-20M	YES	1-20M	YES	2-15M	YES	2-15M	YES	1-15M + 1-20M	YES
2400	(8)	1-15M	NO	1-20M	NO	1-20M	NO	2-15M	NO	1-15M + 1-20M	YES	2-20M	YES	1-10M + 2-20M	YES				
3000	(10)	1-20M	NO	2-15M	NO	2-20M	NO	1-10M + 2-20M	NO										
3600	(12)	1-15M + 1-20M	NO	1-10M + 2-20M	NO														
4200	(14)	1-10M + 2-20M	NO																
4800	(16)																		
5400	(18)																		
6000	(20)																		

NOTES

1. Stirrup spacing (s) and end distance are given in “mm” and “inch”
2. Do not install more than 1-15M + 2-20M bottom bar or equivalent combination of smaller bars.
3. Bottom reinforcement located 89mm (3.5”) from bottom of lintel.
4. This table to be used in conjunction with the “Lintel Design Limitations” & “Lintel Drawing”.
5. Beams with “NO Stirrups Required” do not require stirrups, except provide a minimum of three stirrups at each end of the lintel where Sa (0.2) > 0.4.

Table L6 Continued

Lintel Span		Lintel - 8" Thick x 16" Deep (200mm Thick x 400mm Deep), s = 8" (200mm)																	
		Unfactored Point Load																	
		4kN		7kN		10kN		13kN		16kN		19kN		21kN		24kN		27kN	
		800lb		1500lb		2200lb		2900lb		3500lb		4200lb		4700lb		5300lb		6000lb	
mm	(ft)	Bottom Reinf. Steel	Stirrup End Distance	Bottom Reinf. Steel	Stirrup End Distance	Bottom Reinf. Steel	Stirrup End Distance	Bottom Reinf. Steel	Stirrup End Distance	Bottom Reinf. Steel	Stirrup End Distance	Bottom Reinf. Steel	Stirrup End Distance	Bottom Reinf. Steel	Stirrup End Distance	Bottom Reinf. Steel	Stirrup End Distance	Bottom Reinf. Steel	Stirrup End Distance
900	(3)	1-10M	NO	1-10M	NO	1-10M	NO	1-10M	NO	1-10M	NO	1-10M	YES	1-10M	YES	1-15M	YES	1-15M	YES
1200	(4)	1-10M	NO	1-10M	NO	1-10M	NO	1-10M	NO	1-15M	NO	1-15M	YES	1-15M	YES	1-15M	YES	1-15M	YES
1500	(5)	1-10M	NO	1-10M	NO	1-10M	NO	1-15M	NO	1-15M	NO	1-15M	YES	1-15M	YES	1-15M	YES	1-20M	YES
1800	(6)	1-10M	NO	1-15M	NO	1-15M	NO	1-15M	NO	1-15M	NO	1-15M	YES	1-20M	YES	2-15M	YES	2-15M	YES
2400	(8)	1-15M	NO	1-15M	NO	1-15M	NO	1-20M	NO	1-20M	YES	2-15M	YES	1-15M + 1-20M	YES	2-20M	YES		
3000	(10)	1-15M	NO	1-15M	NO	2-15M	NO	2-15M	NO	1-15M + 1-20M	YES	2-20M	YES	1-15M + 2-20M	YES				
3600	(12)	1-20M	NO	2-15M	NO	1-15M + 1-20M	NO	2-20M	NO	1-10M + 2-20M	YES	1-10M + 3-20M	YES						
4200	(14)	2-15M	NO	2-20M	NO	1-10M + 2-20M	NO	3-20M	NO										
4800	(16)	2-20M	NO	1-15M + 2-20M	NO	1-10M + 3-20M	NO												
5400	(18)	1-10M + 2-20M	NO	1-10M + 3-20M	NO														
6000	(20)	3-20M	NO																

NOTES

1. Stirrup spacing (s) and end distance are given in "mm" and "inch"
2. Do not install more than 4-20M bottom bar or equivalent combination of smaller bars.
3. Bottom reinforcement located 89mm (3.5") from bottom of lintel.
4. This table to be used in conjunction with the "Lintel Design Limitations" & "Lintel Drawing".
5. Beams with "NO Stirrups Required" do not require stirrups, except provide a minimum of three stirrups at each end of the lintel where Sa (0.2) > 0.4.

Lintel Span		Lintel - 8" Thick x 24" Deep (200mm Thick x 600mm Deep), s = 12" (300mm)																	
		Unfactored Point Load																	
		4kN		8kN		12kN		16kN		20kN		24kN		28kN		32kN		36kN	
		800lb		1700lb		2600lb		3500lb		4400lb		5300lb		6200lb		7100lb		8000lb	
mm	(ft)	Bottom Reinf. Steel	Stirrup End Distance	Bottom Reinf. Steel	Stirrup End Distance	Bottom Reinf. Steel	Stirrup End Distance	Bottom Reinf. Steel	Stirrup End Distance	Bottom Reinf. Steel	Stirrup End Distance	Bottom Reinf. Steel	Stirrup End Distance	Bottom Reinf. Steel	Stirrup End Distance	Bottom Reinf. Steel	Stirrup End Distance	Bottom Reinf. Steel	Stirrup End Distance
900	(3)	1-10M	NO	1-10M	NO	1-10M	NO	1-10M	NO	1-10M	NO	1-10M	NO	1-10M	YES	1-10M	YES	1-15M	YES
1200	(4)	1-10M	NO	1-10M	NO	1-10M	NO	1-10M	NO	1-10M	NO	1-10M	NO	1-15M	YES	1-15M	YES	1-15M	YES
1500	(5)	1-10M	NO	1-10M	NO	1-10M	NO	1-10M	NO	1-15M	NO	1-15M	NO	1-15M	YES	1-15M	YES	1-15M	YES
1800	(6)	1-10M	NO	1-10M	NO	1-10M	NO	1-15M	NO	1-15M	NO	1-15M	NO	1-15M	YES	1-20M	YES	1-20M	YES
2400	(8)	1-10M	NO	1-15M	NO	1-15M	NO	1-15M	NO	1-20M	NO	1-20M	YES	1-20M	YES	2-15M	YES	2-15M	YES
3000	(10)	1-15M	NO	1-20M	NO	1-20M	NO	1-20M	NO	1-20M	NO	2-15M	YES	1-15M + 1-20M	YES	2-20M	YES		
3600	(12)	1-20M	NO	1-20M	NO	1-20M	NO	2-15M	NO	2-15M	NO	1-15M + 1-20M	YES	1-10M + 2-20M	YES				
4200	(14)	1-20M	NO	2-15M	NO	2-15M	NO	1-15M + 1-20M	NO	2-20M	YES	1-15M + 2-20M	YES	1-10M + 3-20M	YES				
4800	(16)	2-15M	NO	2-15M	NO	2-20M	NO	1-10M + 2-20M	NO	1-15M + 2-20M	YES	1-10M + 3-20M	YES						
5400	(18)	2-15M	NO	2-20M	NO	1-10M + 2-20M	NO	1-15M + 2-20M	NO	1-10M + 3-20M	YES								
6000	(20)	1-15M + 1-20M	NO	1-10M + 2-20M	NO	3-20M	NO	1-15M + 3-20M	NO										

NOTES

1. Stirrup spacing (s) and end distance are given in "mm" and "inch"
2. Do not install more than 4-20M bottom bar or equivalent combination of smaller bars.
3. Bottom reinforcement located 89mm (3.5") from bottom of lintel.
4. This table to be used in conjunction with the "Lintel Design Limitations" & "Lintel Drawing".
5. Beams with "NO Stirrups Required" do not require stirrups, except provide a minimum of three stirrups at each end of the lintel where Sa (0.2) > 0.4.

Table L6 Continued

Lintel Span		Lintel - 8" Thick x 32" Deep (200mm Thick x 800mm Deep), s = 18" (450mm)																	
		Unfactored Point Load																	
		4kN/m		9kN/m		14kN/m		19kN/m		24kN/m		29kN/m		34kN/m		39kN/m		44kN/m	
mm	(ft)	Bottom Reinf. Steel	Stirrup End Distance	Bottom Reinf. Steel	Stirrup End Distance	Bottom Reinf. Steel	Stirrup End Distance	Bottom Reinf. Steel	Stirrup End Distance	Bottom Reinf. Steel	Stirrup End Distance	Bottom Reinf. Steel	Stirrup End Distance	Bottom Reinf. Steel	Stirrup End Distance	Bottom Reinf. Steel	Stirrup End Distance	Bottom Reinf. Steel	Stirrup End Distance
		800lb/ft		2000lb/ft		3100lb/ft		4200lb/ft		5300lb/ft		6500lb/ft		7600lb/ft		8700lb/ft		9800lb/ft	
900	(3)	1-10M	NO	1-10M	NO	1-10M	NO	1-10M	NO	1-10M	NO	1-10M	NO	1-10M	YES	1-10M	YES	1-10M	YES
1200	(4)	1-10M	NO	1-10M	NO	1-10M	NO	1-10M	NO	1-10M	NO	1-10M	NO	1-10M	YES	1-15M	YES	1-15M	YES
1500	(5)	1-10M	NO	1-10M	NO	1-10M	NO	1-10M	NO	1-10M	NO	1-15M	NO	1-15M	YES	1-15M	YES	1-15M	YES
1800	(6)	1-10M	NO	1-10M	NO	1-10M	NO	1-10M	NO	1-15M	NO	1-15M	NO	1-15M	YES	1-15M	YES	1-15M	YES
2400	(8)	1-10M	NO	1-10M	NO	1-15M	NO	1-15M	NO	1-15M	NO	1-20M	YES	2-15M	YES	2-15M	YES	2-15M	YES
3000	(10)	1-15M	NO	1-15M	NO	1-15M	NO	1-20M	NO	2-15M	NO	2-15M	YES	2-15M	YES	1-15M + 1-20M	YES		
3600	(12)	1-15M	NO	1-20M	NO	1-20M	NO	2-15M	NO	2-15M	NO	1-15M + 1-20M	YES	2-20M	YES				
4200	(14)	1-20M	NO	2-15M	NO	2-15M	NO	2-15M	NO	1-15M + 1-20M	NO	1-10M + 2-20M	YES						
4800	(16)	2-15M	NO	2-15M	NO	2-15M	NO	1-15M + 1-20M	NO	1-10M + 2-20M	YES								
5400	(18)	2-15M	NO	2-15M	NO	1-15M + 1-20M	NO	2-20M	NO	3-20M	YES								
6000	(20)	2-15M	NO	1-15M + 1-20M	NO	2-20M	NO	1-10M + 2-20M	NO										

NOTES

1. Stirrup spacing (s) and end distance are given in "mm" and "inch"
2. Do not install more than 4-20M bottom bar or equivalent combination of smaller bars.
3. Bottom reinforcement located 89mm (3.5") from bottom of lintel.
4. This table to be used in conjunction with the "Lintel Design Limitations" & "Lintel Drawing".
5. Beams with "NO Stirrups Required" do not require stirrups, except provide a minimum of three stirrups at each end of the lintel where Sa (0.2) > 0.4.

INSULATING CONCRETE FORMS
MANUFACTURERS ASSOCIATION
ICF-MA.ORG

Table L7 10” Lintel Reinforcement Concentrated Load

Lintel Span		Lintel - 10” Thick x 8” Deep (250mm Thick x 200mm Deep), s = 3” (75mm)																	
		Unfactored Point Load																	
		4kN		6kN		8kN		10kN		12kN		14kN		16kN		18kN		20kN	
		800lb		1300lb		1700lb		2200lb		2600lb		3100lb		3500lb		4000lb		4400lb	
mm	(ft)	Bottom Reinf. Steel	Stirrup End Distance	Bottom Reinf. Steel	Stirrup End Distance	Bottom Reinf. Steel	Stirrup End Distance	Bottom Reinf. Steel	Stirrup End Distance	Bottom Reinf. Steel	Stirrup End Distance	Bottom Reinf. Steel	Stirrup End Distance	Bottom Reinf. Steel	Stirrup End Distance	Bottom Reinf. Steel	Stirrup End Distance	Bottom Reinf. Steel	Stirrup End Distance
900	(3)	1-10M	NO	1-10M	NO	1-15M	NO	1-15M	NO	1-15M	NO	1-15M	YES	1-15M	YES	1-15M	YES	1-20M	YES
1200	(4)	1-15M	NO	1-15M	NO	1-15M	NO	1-15M	NO	1-15M	NO	1-20M	YES	1-20M	YES	2-15M	YES	2-15M	YES
1500	(5)	1-15M	NO	1-15M	NO	1-20M	NO	1-20M	NO	2-15M	NO	1-15M + 1-20M	YES						
1800	(6)	1-15M	NO	1-20M	NO	2-15M	NO	1-15M + 1-20M	NO										
2400	(8)	2-15M	NO																
3000	(10)																		
3600	(12)																		
4200	(14)																		
4800	(16)																		
5400	(18)																		
6000	(20)																		

NOTES

1. Stirrup spacing (s) and end distance are given in “mm” and “inch”
2. Do not install more than 2-15M bottom bar or equivalent combination of smaller bars.
3. Bottom reinforcement located 89mm (3.5”) from bottom of lintel.
4. This table to be used in conjunction with the “Lintel Design Limitations” & “Lintel Drawing”.
5. Beams with “NO Stirrups Required” do not require stirrups, except provide a minimum of three stirrups at each end of the lintel where Sa (0.2) > 0.4.

Lintel Span		Lintel - 10” Thick x 12” Deep (250mm Thick x 300mm Deep), s = 6” (150mm)																	
		Unfactored Point Load																	
		4kN		6.5kN		9kN		11.5kN		14kN		16.5kN		19kN		21.5kN		24kN	
		800lb		1400lb		2000lb		2500lb		3100lb		3700lb		4200lb		4800lb		5300lb	
mm	(ft)	Bottom Reinf. Steel	Stirrup End Distance	Bottom Reinf. Steel	Stirrup End Distance	Bottom Reinf. Steel	Stirrup End Distance	Bottom Reinf. Steel	Stirrup End Distance	Bottom Reinf. Steel	Stirrup End Distance	Bottom Reinf. Steel	Stirrup End Distance	Bottom Reinf. Steel	Stirrup End Distance	Bottom Reinf. Steel	Stirrup End Distance	Bottom Reinf. Steel	Stirrup End Distance
900	(3)	1-10M	NO	1-10M	NO	1-10M	NO	1-10M	NO	1-15M	NO	1-15M	NO	1-15M	YES	1-15M	YES	1-15M	YES
1200	(4)	1-10M	NO	1-10M	NO	1-10M	NO	1-15M	NO	1-15M	NO	1-15M	NO	1-15M	YES	1-15M	YES	1-15M	YES
1500	(5)	1-10M	NO	1-15M	NO	1-15M	NO	1-15M	NO	1-15M	NO	1-15M	NO	1-20M	YES	1-20M	YES	2-15M	YES
1800	(6)	1-15M	NO	1-15M	NO	1-15M	NO	1-15M	NO	1-20M	NO	1-20M	NO	2-15M	YES	2-15M	YES	1-15M + 1-20M	YES
2400	(8)	1-15M	NO	1-20M	NO	1-20M	NO	2-15M	NO	1-15M + 1-20M	NO	2-20M	YES	1-10M + 2-20M	YES	3-20M	YES		
3000	(10)	1-20M	NO	2-15M	NO	1-15M + 1-20M	NO	1-10M + 2-20M	NO	1-15M + 2-20M	NO								
3600	(12)	1-15M + 1-20M	NO	2-20M	NO	1-15M + 2-20M	NO												
4200	(14)	1-10M + 2-20M	NO	3-20M	NO														
4800	(16)																		
5400	(18)																		
6000	(20)																		

NOTES

1. Stirrup spacing (s) and end distance are given in “mm” and “inch”
2. Do not install more than 3-20M bottom bar or equivalent combination of smaller bars.
3. Bottom reinforcement located 89mm (3.5”) from bottom of lintel.
4. This table to be used in conjunction with the “Lintel Design Limitations” & “Lintel Drawing”.
5. Beams with “NO Stirrups Required” do not require stirrups, except provide a minimum of three stirrups at each end of the lintel where Sa (0.2) > 0.4.

Table L7 Continued

Lintel Span		Lintel - 10" Thick x 16" Deep (250mm Thick x 400mm Deep), s = 8" (200mm)																	
		Unfactored Point Load																	
		4kN		7kN		10kN		13kN		16kN		19kN		21kN		24kN		27kN	
		800lb		1500lb		2200lb		2900lb		3500lb		4200lb		4700lb		5300lb		6000lb	
mm	(ft)	Bottom Reinf. Steel	Stirrup End Distance	Bottom Reinf. Steel	Stirrup End Distance	Bottom Reinf. Steel	Stirrup End Distance	Bottom Reinf. Steel	Stirrup End Distance	Bottom Reinf. Steel	Stirrup End Distance	Bottom Reinf. Steel	Stirrup End Distance	Bottom Reinf. Steel	Stirrup End Distance	Bottom Reinf. Steel	Stirrup End Distance	Bottom Reinf. Steel	Stirrup End Distance
900	(3)	1-10M	NO	1-10M	NO	1-10M	NO	1-10M	NO	1-10M	NO	1-10M	NO	1-10M	NO	1-15M	YES	1-15M	YES
1200	(4)	1-10M	NO	1-10M	NO	1-10M	NO	1-10M	NO	1-15M	NO	1-15M	NO	1-15M	NO	1-15M	YES	1-15M	YES
1500	(5)	1-10M	NO	1-10M	NO	1-10M	NO	1-15M	NO	1-15M	NO	1-15M	NO	1-20M	NO	1-20M	YES	1-20M	YES
1800	(6)	1-10M	NO	1-15M	NO	1-15M	NO	1-15M	NO	1-20M	NO	1-20M	NO	1-20M	NO	2-15M	YES	2-15M	YES
2400	(8)	1-15M	NO	1-20M	NO	1-20M	NO	1-20M	NO	1-20M	NO	2-15M	NO	1-15M + 1-20M	YES	2-20M	YES	1-10M + 2-20M	YES
3000	(10)	1-20M	NO	1-20M	NO	2-15M	NO	2-15M	NO	1-15M + 1-20M	NO	2-20M	NO	1-15M + 2-20M	YES	1-10M + 3-20M	YES		
3600	(12)	1-20M	NO	2-15M	NO	1-15M + 1-20M	NO	2-20M	NO	1-10M + 2-20M	NO	1-10M + 3-20M	YES						
4200	(14)	2-15M	NO	2-20M	NO	1-10M + 2-20M	NO	3-20M	NO	1-15M + 3-20M	NO								
4800	(16)	2-20M	NO	1-10M + 2-20M	NO	1-10M + 3-20M	NO	4-20M	NO										
5400	(18)	1-10M + 2-20M	NO	1-10M + 3-20M	NO	4-20M	NO												
6000	(20)	3-20M	NO	1-10M + 3-20M	NO														

NOTES

1. Stirrup spacing (s) and end distance are given in "mm" and "inch"
2. Do not install more than 4-20M bottom bar or equivalent combination of smaller bars.
3. Bottom reinforcement located 89mm (3.5") from bottom of lintel.
4. This table to be used in conjunction with the "Lintel Design Limitations" & "Lintel Drawing"
5. Beams with "NO Stirrups Required" do not require stirrups, except provide a minimum of three stirrups at each end of the lintel where Sa (0.2) > 0.4.

Lintel Span		Lintel - 10" Thick x 24" Deep (250mm Thick x 600mm Deep), s = 12" (300mm)																	
		Unfactored Point Load																	
		4kN		8kN		12kN		16kN		20kN		24kN		28kN		32kN		36kN	
		800lb		1700lb		2600lb		3500lb		4400lb		5300lb		6200lb		7100lb		8000lb	
mm	(ft)	Bottom Reinf. Steel	Stirrup End Distance	Bottom Reinf. Steel	Stirrup End Distance	Bottom Reinf. Steel	Stirrup End Distance	Bottom Reinf. Steel	Stirrup End Distance	Bottom Reinf. Steel	Stirrup End Distance	Bottom Reinf. Steel	Stirrup End Distance	Bottom Reinf. Steel	Stirrup End Distance	Bottom Reinf. Steel	Stirrup End Distance	Bottom Reinf. Steel	Stirrup End Distance
900	(3)	1-10M	NO	1-10M	NO	1-10M	NO	1-10M	NO	1-10M	NO	1-10M	NO	1-10M	NO	1-10M	NO	1-15M	YES
1200	(4)	1-10M	NO	1-10M	NO	1-10M	NO	1-10M	NO	1-10M	NO	1-10M	NO	1-15M	NO	1-15M	NO	1-15M	YES
1500	(5)	1-10M	NO	1-10M	NO	1-10M	NO	1-10M	NO	1-15M	NO	1-15M	NO	1-15M	NO	1-15M	YES	1-15M	YES
1800	(6)	1-10M	NO	1-10M	NO	1-10M	NO	1-15M	NO	1-15M	NO	1-15M	NO	1-15M	NO	1-20M	YES	1-20M	YES
2400	(8)	1-15M	NO	1-15M	NO	1-15M	NO	1-15M	NO	1-20M	NO	1-20M	NO	2-15M	NO	2-15M	YES	2-15M	YES
3000	(10)	1-15M	NO	1-20M	NO	1-20M	NO	2-15M	NO	2-15M	NO	2-15M	NO	1-15M + 1-20M	NO	2-20M	YES	1-10M + 2-20M	YES
3600	(12)	1-20M	NO	2-15M	NO	2-15M	NO	2-15M	NO	2-15M	NO	2-20M	NO	1-10M + 2-20M	YES	1-15M + 2-20M	YES		
4200	(14)	2-15M	NO	2-15M	NO	2-15M	NO	1-15M + 1-20M	NO	2-20M	NO	1-10M + 2-20M	NO	3-20M	YES				
4800	(16)	2-15M	NO	1-15M + 1-20M	NO	2-20M	NO	1-10M + 2-20M	NO	1-15M + 2-20M	NO	1-10M + 3-20M	NO						
5400	(18)	1-15M + 1-20M	NO	2-20M	NO	1-10M + 2-20M	NO	1-15M + 2-20M	NO	1-10M + 3-20M	NO								
6000	(20)	2-20M	NO	1-10M + 2-20M	NO	3-20M	NO	1-15M + 3-20M	NO										

NOTES

1. Stirrup spacing (s) and end distance are given in "mm" and "inch"
2. Do not install more than 4-20M bottom bar or equivalent combination of smaller bars.
3. Bottom reinforcement located 89mm (3.5") from bottom of lintel.
4. This table to be used in conjunction with the "Lintel Design Limitations" & "Lintel Drawing"
5. Beams with "NO Stirrups Required" do not require stirrups, except provide a minimum of three stirrups at each end of the lintel where Sa (0.2) > 0.4.

Table L7 Continued

Lintel Span		Lintel - 10" Thick x 32" Deep (250mm Thick x 800mm Deep), s = 18" (450mm)																	
		Unfactored Point Load																	
		4kN/m		9kN/m		14kN/m		19kN/m		24kN/m		29kN/m		34kN/m		39kN/m		44kN/m	
		800lb/ft		2000lb/ft		3100lb/ft		4200lb/ft		5300lb/ft		6500lb/ft		7600lb/ft		8700lb/ft		9800lb/ft	
mm	(ft)	Bottom Reinf. Steel	Stirrup End Distance	Bottom Reinf. Steel	Stirrup End Distance	Bottom Reinf. Steel	Stirrup End Distance	Bottom Reinf. Steel	Stirrup End Distance	Bottom Reinf. Steel	Stirrup End Distance	Bottom Reinf. Steel	Stirrup End Distance	Bottom Reinf. Steel	Stirrup End Distance	Bottom Reinf. Steel	Stirrup End Distance	Bottom Reinf. Steel	Stirrup End Distance
900	(3)	1-10M	NO	1-10M	NO	1-10M	NO	1-10M	NO	1-10M	NO	1-10M	NO	1-10M	NO	1-10M	NO	1-10M	YES
1200	(4)	1-10M	NO	1-10M	NO	1-10M	NO	1-10M	NO	1-10M	NO	1-10M	NO	1-10M	NO	1-15M	NO	1-15M	YES
1500	(5)	1-10M	NO	1-10M	NO	1-10M	NO	1-10M	NO	1-10M	NO	1-15M	NO	1-15M	NO	1-15M	YES	1-15M	YES
1800	(6)	1-10M	NO	1-10M	NO	1-10M	NO	1-10M	NO	1-15M	NO	1-15M	NO	1-15M	NO	1-15M	YES	1-20M	YES
2400	(8)	1-10M	NO	1-10M	NO	1-15M	NO	1-15M	NO	1-15M	NO	1-20M	NO	2-15M	NO	2-15M	YES	2-15M	YES
3000	(10)	1-15M	NO	1-15M	NO	1-15M	NO	1-20M	NO	2-15M	NO	2-15M	NO	2-15M	NO	1-15M + 1-20M	YES	1-15M + 1-20M	YES
3600	(12)	1-15M	NO	1-20M	NO	1-20M	NO	2-15M	NO	2-15M	NO	2-20M	NO	2-20M	YES				
4200	(14)	1-20M	NO	2-15M	NO	2-15M	NO	2-15M	NO	1-15M + 1-20M	NO	1-10M + 2-20M	NO	1-15M + 2-20M	YES				
4800	(16)	2-15M	NO	2-15M	NO	2-15M	NO	1-15M + 1-20M	NO	1-10M + 2-20M	NO	3-20M	NO						
5400	(18)	2-15M	NO	2-15M	NO	1-15M + 1-20M	NO	2-20M	NO	3-20M	NO								
6000	(20)	2-15M	NO	1-15M + 1-20M	NO	1-10M + 2-20M	NO	1-15M + 2-20M	NO	1-15M + 3-20M	NO								

NOTES

1. Stirrup spacing (s) and end distance are given in "mm" and "inch"
2. Do not install more than 4-20M bottom bar or equivalent combination of smaller bars.
3. Bottom reinforcement located 89mm (3.5") from bottom of lintel.
4. This table to be used in conjunction with the "Lintel Design Limitations" & "Lintel Drawing".
5. Beams with "NO Stirrups Required" do not require stirrups, except provide a minimum of three stirrups at each end of the lintel where Sa (0.2) > 0.4.

INSULATING CONCRETE FORMS
MANUFACTURERS ASSOCIATION
ICF-MA.ORG

Table L8 12” Lintel Reinforcement Concentrated Load

Lintel Span		Lintel - 12” Thick x 8” Deep (300mm Thick x 200mm Deep), s = 3” (75mm)																	
		Unfactored Point Load																	
		4kN		6kN		8kN		10kN		12kN		14kN		16kN		18kN		20kN	
		800lb		1300lb		1700lb		2200lb		2600lb		3100lb		3500lb		4000lb		4400lb	
mm	(ft)	Bottom Reinf. Steel	Stirrup End Distance	Bottom Reinf. Steel	Stirrup End Distance	Bottom Reinf. Steel	Stirrup End Distance	Bottom Reinf. Steel	Stirrup End Distance	Bottom Reinf. Steel	Stirrup End Distance	Bottom Reinf. Steel	Stirrup End Distance	Bottom Reinf. Steel	Stirrup End Distance	Bottom Reinf. Steel	Stirrup End Distance	Bottom Reinf. Steel	Stirrup End Distance
900	(3)	1-10M	NO	1-10M	NO	1-15M	NO	1-15M	NO	1-15M	NO	1-15M	NO	1-15M	YES	1-15M	YES	1-20M	YES
1200	(4)	1-15M	NO	1-15M	NO	1-15M	NO	1-15M	NO	1-15M	NO	1-20M	NO	1-20M	YES	2-15M	YES	2-15M	YES
1500	(5)	1-15M	NO	1-15M	NO	1-20M	NO	1-20M	NO	2-15M	NO	2-15M	NO	1-15M + 1-20M	YES				
1800	(6)	1-15M	NO	1-20M	NO	2-15M	NO	2-15M	NO	2-20M	NO								
2400	(8)	2-15M	NO	2-20M	NO														
3000	(10)																		
3600	(12)																		
4200	(14)																		
4800	(16)																		
5400	(18)																		
6000	(20)																		

NOTES

1. Stirrup spacing (s) and end distance are given in “mm” and “inch”
2. Do not install more than 2-20M bottom bar or equivalent combination of smaller bars.
3. Bottom reinforcement located 89mm (3.5”) from bottom of lintel.
4. This table to be used in conjunction with the “Lintel Design Limitations” & “Lintel Drawing”.
5. Beams with “NO Stirrups Required” do not require stirrups, except provide a minimum of three stirrups at each end of the lintel where Sa (0.2) > 0.4.

Lintel Span		Lintel - 12” Thick x 12” Deep (300mm Thick x 300mm Deep), s = 6” (150mm)																	
		Unfactored Point Load																	
		4kN		6.5kN		9kN		11.5kN		14kN		16.5kN		19kN		21.5kN		24kN	
		800lb		1400lb		2000lb		2500lb		3100lb		3700lb		4200lb		4800lb		5300lb	
mm	(ft)	Bottom Reinf. Steel	Stirrup End Distance	Bottom Reinf. Steel	Stirrup End Distance	Bottom Reinf. Steel	Stirrup End Distance	Bottom Reinf. Steel	Stirrup End Distance	Bottom Reinf. Steel	Stirrup End Distance	Bottom Reinf. Steel	Stirrup End Distance	Bottom Reinf. Steel	Stirrup End Distance	Bottom Reinf. Steel	Stirrup End Distance	Bottom Reinf. Steel	Stirrup End Distance
900	(3)	1-10M	NO	1-10M	NO	1-10M	NO	1-10M	NO	1-15M	NO	1-15M	NO	1-15M	NO	1-15M	NO	1-15M	YES
1200	(4)	1-10M	NO	1-10M	NO	1-10M	NO	1-15M	NO	1-15M	NO	1-15M	NO	1-15M	NO	1-20M	NO	1-20M	YES
1500	(5)	1-10M	NO	1-15M	NO	1-15M	NO	1-15M	NO	1-20M	NO	1-20M	NO	1-20M	NO	1-20M	YES	2-15M	YES
1800	(6)	1-15M	NO	1-15M	NO	1-20M	NO	1-20M	NO	1-20M	NO	1-20M	NO	2-15M	NO	2-15M	YES	1-15M + 1-20M	YES
2400	(8)	1-20M	NO	1-20M	NO	1-20M	NO	2-15M	NO	1-15M + 1-20M	NO	2-20M	NO	1-10M + 2-20M	NO	1-15M + 2-20M	YES	1-10M + 3-20M	YES
3000	(10)	1-20M	NO	2-15M	NO	1-15M + 1-20M	NO	2-20M	NO	1-15M + 2-20M	NO	1-10M + 3-20M	NO	4-20M	YES				
3600	(12)	2-15M	NO	2-20M	NO	1-15M + 2-20M	NO	1-10M + 3-20M	NO										
4200	(14)	2-20M	NO	3-20M	NO	4-20M	NO												
4800	(16)																		
5400	(18)																		
6000	(20)																		

NOTES

1. Stirrup spacing (s) and end distance are given in “mm” and “inch”
2. Do not install more than 4-20M bottom bar or equivalent combination of smaller bars.
3. Bottom reinforcement located 89mm (3.5”) from bottom of lintel.
4. This table to be used in conjunction with the “Lintel Design Limitations” & “Lintel Drawing”.
5. Beams with “NO Stirrups Required” do not require stirrups, except provide a minimum of three stirrups at each end of the lintel where Sa (0.2) > 0.4.

Table L8 Continued

Lintel Span		Lintel - 12" Thick x 16" Deep (300mm Thick x 400mm Deep), s = 8" (200mm)																	
		Unfactored Point Load																	
		4kN		7kN		10kN		13kN		16kN		19kN		21kN		24kN		27kN	
		800lb		1500lb		2200lb		2900lb		3500lb		4200lb		4700lb		5300lb		6000lb	
mm	(ft)	Bottom Reinf. Steel	Stirrup End Distance	Bottom Reinf. Steel	Stirrup End Distance	Bottom Reinf. Steel	Stirrup End Distance	Bottom Reinf. Steel	Stirrup End Distance	Bottom Reinf. Steel	Stirrup End Distance	Bottom Reinf. Steel	Stirrup End Distance	Bottom Reinf. Steel	Stirrup End Distance	Bottom Reinf. Steel	Stirrup End Distance	Bottom Reinf. Steel	Stirrup End Distance
900	(3)	1-10M	NO	1-10M	NO	1-10M	NO	1-10M	NO	1-10M	NO	1-10M	NO	1-10M	NO	1-15M	NO	1-15M	NO
1200	(4)	1-10M	NO	1-10M	NO	1-10M	NO	1-10M	NO	1-15M	NO	1-15M	NO	1-15M	NO	1-15M	NO	1-15M	NO
1500	(5)	1-10M	NO	1-10M	NO	1-10M	NO	1-15M	NO	1-15M	NO	1-15M	NO	1-20M	NO	1-20M	NO	1-20M	YES
1800	(6)	1-10M	NO	1-15M	NO	1-15M	NO	1-15M	NO	1-20M	NO	1-20M	NO	1-20M	NO	2-15M	NO	2-15M	YES
2400	(8)	1-15M	NO	1-20M	NO	1-20M	NO	1-20M	NO	1-20M	NO	2-15M	NO	1-15M + 1-20M	NO	2-20M	NO	1-15M + 2-20M	YES
3000	(10)	1-20M	NO	1-20M	NO	2-15M	NO	2-15M	NO	1-15M + 1-20M	NO	2-20M	NO	1-15M + 2-20M	NO	1-10M + 3-20M	YES		
3600	(12)	1-20M	NO	2-15M	NO	1-15M + 1-20M	NO	2-20M	NO	1-10M + 2-20M	NO	1-10M + 3-20M	NO	4-20M	NO				
4200	(14)	2-15M	NO	2-20M	NO	1-10M + 2-20M	NO	1-15M + 2-20M	NO	1-10M + 3-20M	NO								
4800	(16)	2-20M	NO	1-10M + 2-20M	NO	1-10M + 3-20M	NO	4-20M	NO										
5400	(18)	1-10M + 2-20M	NO	1-10M + 3-20M	NO	4-20M	NO												
6000	(20)	3-20M	NO																

NOTES

1. Stirrup spacing (s) and end distance are given in "mm" and "inch"
2. Do not install more than 4-20M bottom bar or equivalent combination of smaller bars.
3. Bottom reinforcement located 89mm (3.5") from bottom of lintel.
4. This table to be used in conjunction with the "Lintel Design Limitations" & "Lintel Drawing".
5. Cells with zero end distance do not require stirrups, except provide a minimum of three stirrups at each end of the lintel where Sa (0.2) > 0.4.

Lintel Span		Lintel - 12" Thick x 24" Deep (300mm Thick x 600mm Deep), s = 12" (300mm)																	
		Unfactored Point Load																	
		4kN		8kN		12kN		16kN		20kN		24kN		28kN		32kN		36kN	
		800lb		1700lb		2600lb		3500lb		4400lb		5300lb		6200lb		7100lb		8000lb	
mm	(ft)	Bottom Reinf. Steel	Stirrup End Distance	Bottom Reinf. Steel	Stirrup End Distance	Bottom Reinf. Steel	Stirrup End Distance	Bottom Reinf. Steel	Stirrup End Distance	Bottom Reinf. Steel	Stirrup End Distance	Bottom Reinf. Steel	Stirrup End Distance	Bottom Reinf. Steel	Stirrup End Distance	Bottom Reinf. Steel	Stirrup End Distance	Bottom Reinf. Steel	Stirrup End Distance
900	(3)	1-10M	NO	1-10M	NO	1-10M	NO	1-10M	NO	1-10M	NO	1-10M	NO	1-10M	NO	1-10M	NO	1-15M	NO
1200	(4)	1-10M	NO	1-10M	NO	1-10M	NO	1-10M	NO	1-10M	NO	1-10M	NO	1-15M	NO	1-15M	NO	1-15M	NO
1500	(5)	1-10M	NO	1-10M	NO	1-10M	NO	1-10M	NO	1-15M	NO	1-15M	NO	1-15M	NO	1-15M	NO	1-15M	NO
1800	(6)	1-10M	NO	1-10M	NO	1-10M	NO	1-15M	NO	1-15M	NO	1-15M	NO	1-15M	NO	1-20M	NO	1-20M	NO
2400	(8)	1-15M	NO	1-15M	NO	1-15M	NO	1-15M	NO	1-20M	NO	1-20M	NO	2-15M	NO	2-15M	NO	2-15M	YES
3000	(10)	1-15M	NO	1-20M	NO	1-20M	NO	2-15M	NO	2-15M	NO	2-15M	NO	1-15M + 1-20M	NO	2-20M	NO	1-10M + 2-20M	YES
3600	(12)	1-20M	NO	2-15M	NO	2-15M	NO	2-15M	NO	2-15M	NO	2-20M	NO	1-10M + 2-20M	NO	1-15M + 2-20M	NO		
4200	(14)	2-15M	NO	2-15M	NO	2-15M	NO	1-15M + 1-20M	NO	2-20M	NO	1-10M + 2-20M	NO	3-20M	NO				
4800	(16)	2-15M	NO	1-15M + 1-20M	NO	2-20M	NO	1-10M + 2-20M	NO	1-15M + 2-20M	NO	1-10M + 3-20M	NO	4-20M	NO				
5400	(18)	1-15M + 1-20M	NO	2-20M	NO	1-10M + 2-20M	NO	3-20M	NO	1-10M + 3-20M	NO	4-20M	NO						
6000	(20)	2-20M	NO	1-10M + 2-20M	NO	3-20M	NO	1-15M + 3-20M	NO										

NOTES

1. Stirrup spacing (s) and end distance are given in "mm" and "inch"
2. Do not install more than 4-20M bottom bar or equivalent combination of smaller bars.
3. Bottom reinforcement located 89mm (3.5") from bottom of lintel.
4. This table to be used in conjunction with the "Lintel Design Limitations" & "Lintel Drawing".
5. Cells with zero end distance do not require stirrups, except provide a minimum of three stirrups at each end of the lintel where Sa (0.2) > 0.4.

Table L8 Continued

Lintel Span		Lintel - 12" Thick x 32" Deep (300mm Thick x 800mm Deep), s = 18" (450mm)																	
		Unfactored Point Load																	
		4kN/m		9kN/m		14kN/m		19kN/m		24kN/m		29kN/m		34kN/m		39kN/m		44kN/m	
		800lb/ft		2000lb/ft		3100lb/ft		4200lb/ft		5300lb/ft		6500lb/ft		7600lb/ft		8700lb/ft		9800lb/ft	
mm	(ft)	Bottom Reinf. Steel	Stirrup End Distance	Bottom Reinf. Steel	Stirrup End Distance	Bottom Reinf. Steel	Stirrup End Distance	Bottom Reinf. Steel	Stirrup End Distance	Bottom Reinf. Steel	Stirrup End Distance	Bottom Reinf. Steel	Stirrup End Distance	Bottom Reinf. Steel	Stirrup End Distance	Bottom Reinf. Steel	Stirrup End Distance	Bottom Reinf. Steel	Stirrup End Distance
900	(3)	1-10M	NO	1-10M	NO	1-10M	NO	1-10M	NO	1-10M	NO	1-10M	NO	1-10M	NO	1-10M	NO	1-10M	NO
1200	(4)	1-10M	NO	1-10M	NO	1-10M	NO	1-10M	NO	1-10M	NO	1-10M	NO	1-10M	NO	1-15M	NO	1-15M	NO
1500	(5)	1-10M	NO	1-10M	NO	1-10M	NO	1-10M	NO	1-10M	NO	1-15M	NO	1-15M	NO	1-15M	NO	1-15M	NO
1800	(6)	1-10M	NO	1-10M	NO	1-10M	NO	1-10M	NO	1-15M	NO	1-15M	NO	1-15M	NO	1-15M	NO	1-15M	NO
2400	(8)	1-10M	NO	1-15M	NO	1-15M	NO	1-15M	NO	1-15M	NO	1-20M	NO	2-15M	NO	2-15M	NO	1-15M + 1-20M	NO
3000	(10)	1-15M	NO	1-15M	NO	1-15M	NO	1-20M	NO	2-15M	NO	2-15M	NO	1-15M + 1-20M	NO	1-15M + 1-20M	NO	2-20M	YES
3600	(12)	1-15M	NO	1-20M	NO	1-20M	NO	2-15M	NO	1-15M + 1-20M	NO	1-15M + 1-20M	NO	2-20M	NO	1-15M + 2-20M	NO		
4200	(14)	1-20M	NO	2-15M	NO	2-15M	NO	1-15M + 1-20M	NO	1-15M + 1-20M	NO	1-10M + 2-20M	NO	1-15M + 2-20M	NO				
4800	(16)	2-15M	NO	1-15M + 1-20M	NO	1-15M + 1-20M	NO	1-15M + 1-20M	NO	1-10M + 2-20M	NO	3-20M	NO						
5400	(18)	1-15M + 1-20M	NO	1-15M + 1-20M	NO	1-15M + 1-20M	NO	3-20M	NO	3-20M	NO	1-15M + 3-20M	NO						
6000	(20)	1-15M + 1-20M	NO	2-20M	NO	1-10M + 2-20M	NO	1-15M + 2-20M	NO	1-15M + 3-20M	NO								

NOTES

1. Stirrup spacing (s) and end distance are given in "mm" and "inch"
2. Do not install more than 4-20M bottom bar or equivalent combination of smaller bars.
3. Bottom reinforcement located 89mm (3.5") from bottom of lintel.
4. This table to be used in conjunction with the "Lintel Design Limitations" & "Lintel Drawing"
5. Cells with zero end distance do not require stirrups, except provide a minimum of three stirrups at each end of the lintel where Sa (0.2) > 0.4.

INSULATING CONCRETE FORMS
MANUFACTURERS ASSOCIATION
ICF-MA.ORG

Concentrated Point Load Table

Table C.1. Maximum Unfactored Point Load on a Solid Wall Without Opening

Solid Wall Length Under a Point Load, m(ft)	0.91 (3)	1.22 (4)	1.52 (5)
Maximum Unfactored Point Load, kN	225	300	375

NOTES:

1. Provide beam pockets, as necessary.
2. In addition to the wall reinforcing required in the following tables, two additional 15M vertical bars shall be installed directly below the point load.
3. Maximum unfactored point loads given in Table C. 1 are only the wall capacity. It is the responsibility of the roof and floor designer to ensure adequate bearing for all framing members is provided on the concrete walls.



INSULATING CONCRETE FORMS
MANUFACTURERS ASSOCIATION
ICF-MA.ORG

Stair Opening Tables

Table A.12. Above Grade Wall Distributed Horizontal Reinforcement at Stair Openings

Seismic Zone Classification: $S_a(0.2) \leq 1.75$

Hourly Wind Pressure: $q_{1/50} \leq 1.05$

Wall Thickness		Maximum Stair Opening (Laterally Unsupported Length at Top of the Wall)		Block Height (in)	Horizontal Steel (Size and Spacing), mm (in)								
					Seismic Zone Classification, $S_a(0.2)$								
mm	(in)	m	(ft)		≤ 0.4			≤ 0.7			≤ 1.75		
					Hourly Wind Pressure, $q_{1/50}$ (kPa)								
					≤ 0.5			≤ 0.75			≤ 1.05		
150	(6)	4.6	(15)	12" and 18"	10M @	450	(18)	15M @	450	(18)	15M @	300	(12)
				16"	10M @	400	(16)	15M @	400	(16)	15M @	300	(12)
200	(8)	5.2	(17)	12" and 18"	10M @	450	(18)	15M @	450	(18)	15M @	300	(12)
				16"	10M @	400	(16)	15M @	400	(16)	15M @	300	(12)
250	(10)	5.2	(17)	12" and 18"	10M @	450	(18)	15M @	450	(18)	15M @	300	(12)
				16"	10M @	400	(16)	15M @	400	(16)	15M @	300	(12)
300	(12)	5.8	(19)	12" and 18"	10M @	450	(18)	10M @	450	(18)	15M @	300	(12)
				16"	10M @	400	(16)	10M @	400	(16)	15M @	300	(12)

NOTES

- This table to be used in conjunction with the "Design Parameters".
- This table applies to all height of above grade walls where there is no lateral supports at the floor level because of stair opening.
- The laterally unsupported length at the top of the wall is the dimension of the stair opening parallel to the wall.
- Single bars are to be staggered and the vertical bars are to be placed between these staggered bars, as per Detail A.1 and A.2.
- Increase the horizontal reinforcement as per this table and extend beyond the stair opening a minimum of 900mm (3'-0"), bend bars if necessary at wall corners.
- Provide a minimum of 1.22m (4'-0") length of laterally supported wall on each side of the opening. The 1.22m (4'-0") length may be a perpendicular wall on the same side as the stair opening. Bend horizontal bars around the corner to provide the minimum required 900mm (3'-0") extension.
- Increase the vertical reinforcement on each side of the stair opening per the "Design Limitation" noted in section 5.5.5.
- Place the reinforcing for 6", 8" and 10" thick wall in accordance with Detail A.1.
- Provide two layers of indicated horizontal reinforcing for 300mm (12") walls. Place each layer as shown in Detail A.2.
- Alternating horizontal bar spacing of 12" o.c. and 24" o.c. may be used to achieve an average spacing of 18" o.c. where 18" o.c. spacing is specified for horizontal bars.
- Provide 3 horizontal bars in every two rows of 18" high block to achieve an average spacing of 12" o.c. where 12" spacing o.c. is specified for horizontal bars.
- Provide 4 horizontal bars in every three rows of 16" high block to achieve an average spacing of 12" o.c. where 12" spacing o.c. is specified for horizontal bars.

Table B. 5. Below Grade Wall Distributed Horizontal Reinforcement at Stair Opening for Seismic Zone Classification $S_a(0.2) \leq 0.7$, Hourly Wind Pressure , $q_{1/50} \leq 1.05$ kPa, and Backfill

Seismic Zone Classification: $S_a(0.2) \leq 0.7$

Hourly Wind Pressure: $q_{1/50} \leq 1.05$

Backfill Equivalent Fluid Density: 480 kg/m³ (30pcf)

Wall Thickness		Block Height (in)	Horizontal Steel (Size and Spacing), mm (in)											
			Seismic Zone Classification, $S_a(0.2)$											
mm	(in)		2.44m (8')			3.05m (10')			3.66m (12')			4.27m (14')		
		Seismic Zone Classification, $S_a(0.2) \leq 0.25$												
150	(6)	12" and 18"	15M @	450	(18)	2- 15M @	450	(18)						
		16"	15M @	400	(16)	2- 15M @	400	(16)						
200	(8)	12" and 18"	15M @	450	(18)	2- 15M @	450	(18)	2- 15M @	450	(18)	2- 15M @	300	(12)
		16"	15M @	400	(16)	15M @	400	(16)	2- 15M @	400	(16)	2- 15M @	400	(16)
250	(10)	12" and 18"	15M @	450	(18)	15M @	450	(18)	2- 15M @	450	(18)	2- 15M @	450	(18)
		16"	15M @	400	(16)	15M @	400	(16)	15M @	400	(16)	2- 15M @	400	(16)
300	(12)	12" and 18"	15M @	450	(18)	15M @	450	(18)	15M @	450	(18)	2- 15M @	450	(18)
		16"	15M @	400	(16)	15M @	400	(16)	15M @	400	(16)	2- 15M @	400	(16)
		Seismic Zone Classification, $0.25 < S_a(0.2) \leq 0.7$												
150	(6)	12" and 18"												
		16"												
200	(8)	12" and 18"	2- 15M @	450	(18)									
		16"	2- 15M @	400	(16)									
250	(10)	12" and 18"	2- 15M @	450	(18)	2- 15M @	450	(18)						
		16"	15M @	400	(16)	2- 15M @	400	(16)						
300	(12)	12" and 18"	15M @	450	(18)	2- 15M @	450	(18)	2- 15M @	450	(18)			
		16"	15M @	400	(16)	2- 15M @	400	(16)	2- 15M @	400	(16)			

NOTES

1. This table to be used in conjunction with the "Design Parameters".
2. This table applies to all height of below grade walls where there is no lateral supports at the floor level because of stair opening.
3. The laterally unsupported length at the top of the wall is the dimension of the stair opening parallel to the wall.
4. The below grade wall maybe backfilled up to 6" below the top of the wall.
5. Single bars are to be staggered between first two slots of ICF web on inside face of wall. The vertical bars are to be placed between these staggered bars, as per Detail B.1.
6. Where two bars are specified, they are to be placed as a single bundled bar staggered between the first two slots of the ICF web on inside face of the wall. The vertical bars are to be placed between these staggered bars, as per Detail B.1.
7. Increase the horizontal reinforcement as per this table and extend beyond the stair opening a minimum of 900mm (3'-0"), bend bars if necessary at wall corners.
8. Provide a minimum of 1.22m (4'-0") length of laterally supported wall on each side of the opening. The 1.22m (4'-0") length may be a perpendicular wall on the same side as the stair opening. Bend horizontal bars around the corner to provide the minimum required 900mm (3'-0") extension.
9. Increase the vertical reinforcement on each side of the stair opening per the "Design Limitation" noted in section 5.5.5.
10. Reinforce the foundation wall at the stair opening as per the below grade wall reinforcement tables and this table for a minimum of 1.22m (4'-0") beyond each end of the stair opening for foundation wall that would not otherwise require reinforcing.
11. Basement walls with stair opening at locations with Seismic Zone Classification $S_a(0.2) > 0.7$ or Backfill Equivalent Fluid Density > 480 kg/m³ (30pcf) shall be designed by a professional engineer.
12. Alternating horizontal bar spacing of 12" o.c. and 24" o.c. may be used to achieve an average spacing of 18" o.c. where 18" o.c. spacing is specified for horizontal bars.
13. Provide 3 horizontal bars in every two rows of 18" high block to achieve an average spacing of 12" o.c. where 12" spacing o.c. is specified for horizontal bars.
14. Provide 4 horizontal bars in every three rows of 16" high block to achieve an average spacing of 12" o.c. where 12" spacing o.c. is specified for horizontal bars.

Table A.13. Bar Spacing Required at Each Side of the Stair Opening

S _{Table} , mm (in)	Laterally Unsupported Length of the Wall (Stair Opening Length), m (ft)						
	5.7 (19)	5.1 (17)	4.5 (15)	3.9 (13)	2.7 (9)	2.1 (7)	1.5 (5)
	S _{REDUCED}						
1200 (48)	350 (14)	375 (15)	400 (16)	450 (18)	550 (22)	625 (25)	725 (29)
1050 (42)	300 (12)	325 (13)	350 (14)	400 (16)	475 (19)	550 (22)	625 (25)
1000 (40)	275 (11)	300 (12)	325 (13)	375 (15)	450 (18)	525 (21)	600 (24)
900 (36)	250 (10)	275 (11)	300 (12)	325 (13)	400 (16)	475 (19)	550 (22)
800 (32)	225 (9)	250 (10)	275 (11)	300 (12)	375 (15)	425 (17)	475 (19)
750 (30)	200 (8)	225 (9)	250 (10)	275 (11)	350 (14)	400 (16)	450 (18)
600 (24)	175 (7)	175 (7)	200 (8)	225 (9)	275 (11)	300 (12)	350 (14)
450 (18)			150 (6)	150 (6)	200 (8)	225 (9)	275 (11)
400 (16)				150 (6)	175 (7)	200 (8)	225 (9)
300 (12)						150 (6)	175 (7)

NOTES:

1. S_{REDUCED} = the bar spacing (mm/in) required at the sides of the stair opening.
2. S_{TABLES} = the required bar spacing (mm/in) for a laterally supported wall as determined from above grade and below grade walls tables.
3. If the spacing of the additional vertical reinforcing required on each side of openings, described in the equation given in part 5.5., is less than 150mm (6"), a local design professional shall be retained to prepare the design in accordance with applicable standards.

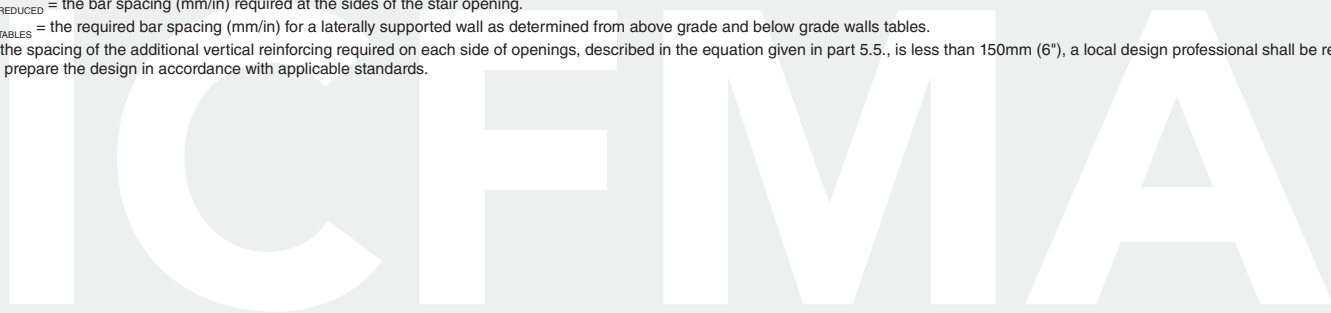

INSULATING CONCRETE FORMS
 MANUFACTURERS ASSOCIATION
 ICF-MA.ORG

Laterally Supported Foundation Wall Detail and Table

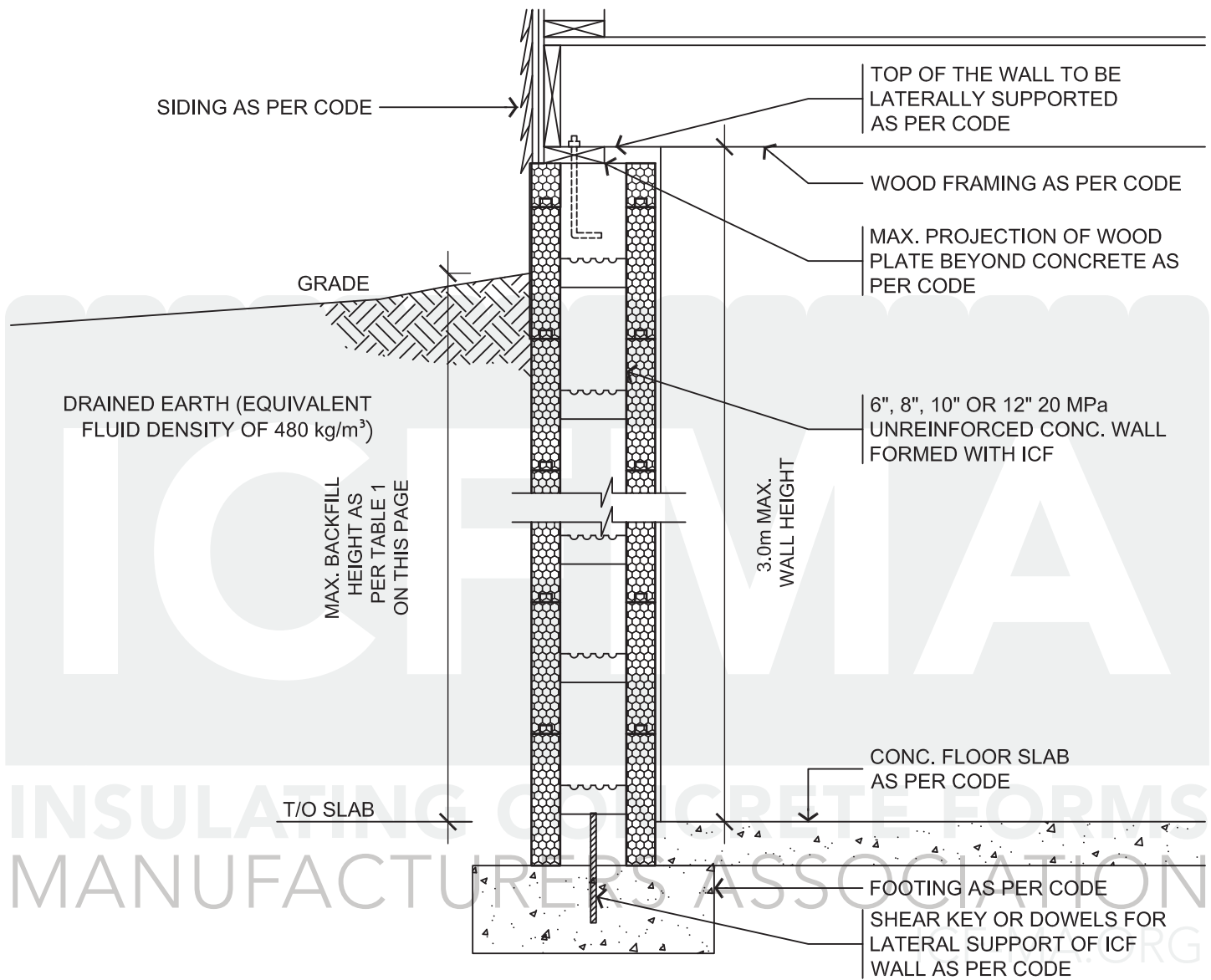

Detail B.2. Laterally Supported Foundation Wall

Table B.6. Maximum Height of Finish Ground Above Basement Floor

Maximum Height of Finish Ground Above Basement Floor			
Minimum Wall Thickness	Height of Foundation Wall		
	≤ 2.5m (8'-2")	>2.5m & ≤2.75m (9'-0")	>2.75m & ≤3.0m (9'-10")
6"	1.8m (5'-10")	1.6m (5'-3")	1.6m (5'-3")
8"	2.3m (7'-6")	2.3m (7'-6")	2.2m (7'-2")
10"	2.3m (7'-6")	2.6m (8'-6")	2.85m (9'-4")
12"	2.3m (7'-6")	2.6m (8'-6")	2.85m (9'-4")

NOTES:

1. This section references Part 9 of the 2015 National Building Code of Canada.
2. This detail applies to one- and two-story buildings conforming to part 9 of the 2015 National Building Code of Canada.
3. This table is a copy of NBCC 2015 T.9.15.4.2-A and OBC 2012(r2020) T.9.15.4.2-A.
4. This table to be used in conjunction with section 5.6. of this design manual.

Laterally Unsupported Foundation Wall Detail and Table (Knee Wall)

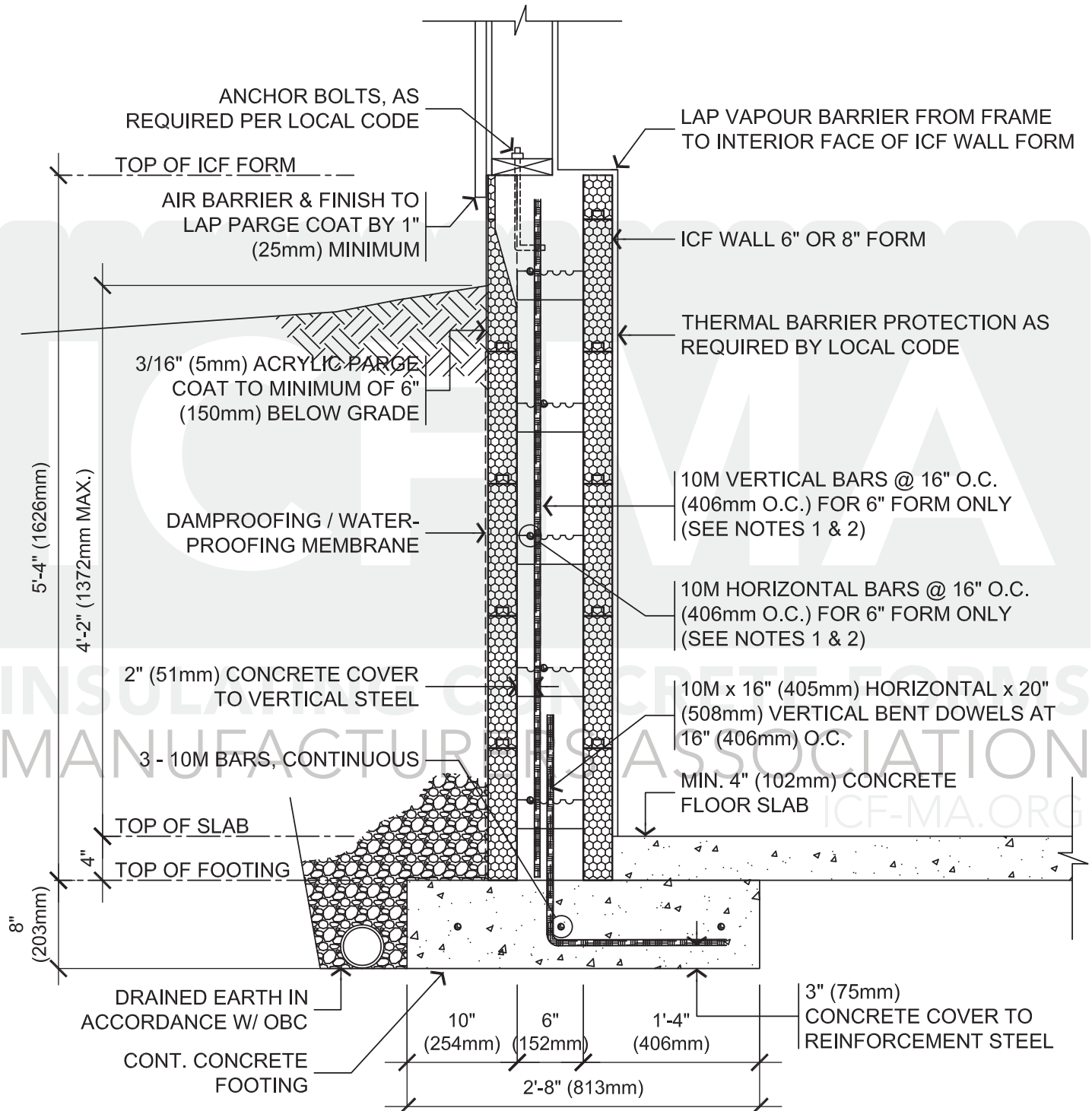

NOTES:

1. This detail applies to one- and two-story buildings conforming to part 9 of the 2015 National Building Code of Canada.
2. Wall reinforcing not required when using 8" forms or thicker.
3. Wall reinforcing not required for 6" forms where the backfill height above basement floor does not exceed 2'-7".
4. Footing reinforcement and dowels are required for all cases.
5. Refer to section 5.7., for additional information.

Detail B.3. Laterally Unsupported Foundation Wall (Knee Wall)

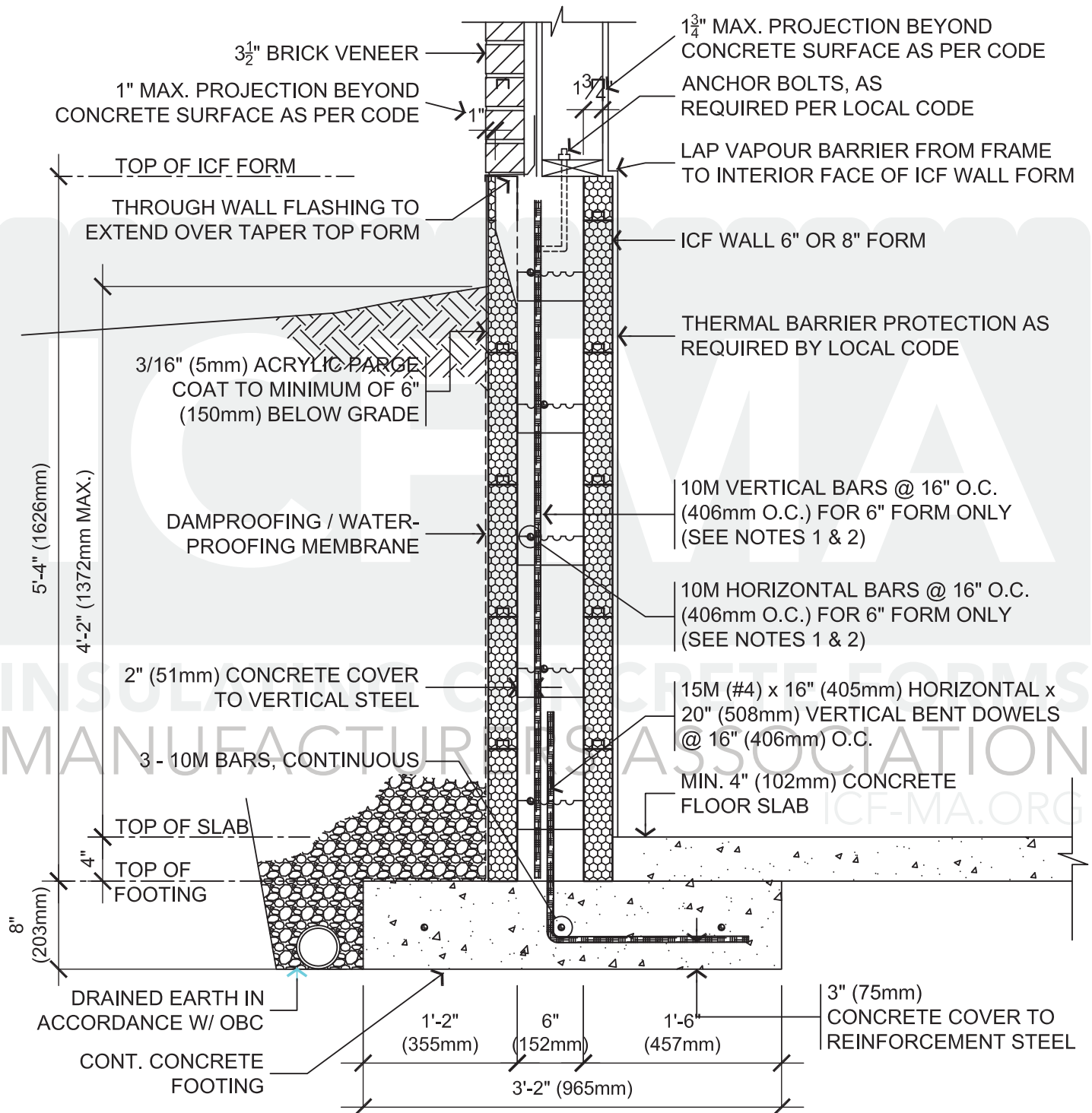

NOTES:

1. This detail applies to one- and two-story buildings conforming to part 9 of the 2015 National Building Code of Canada.
2. Wall reinforcing not required when using 8" forms.
3. Wall reinforcing not required for 6" forms where the backfill height above basement floor does not exceed 2'-7".
4. Footing reinforcement and dowels are required for all cases.
5. Refer to section 5.7, for additional information.

Detail B.4. Laterally Unsupported Foundation Wall (Knee Wall) with Brick Veneer

Ledger Connection Detail and Table

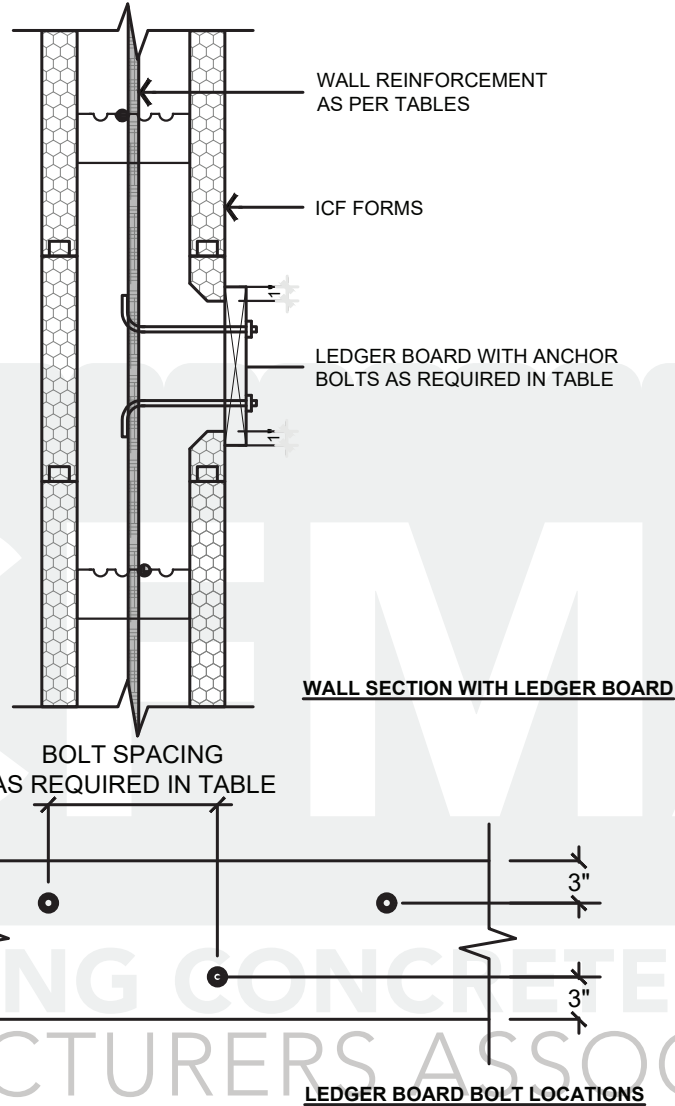

Detail C.1. Wood Ledger Connection

Table C.2. Floor Ledger Anchor Bolts Size and Spacing

Anchor Bolt Diameter	Minimum Spacing of Staggered Anchors, in					
	Tie Spacing	Floor span, ft (m)				
		8' (2.44m)	12' (3.66m)	16' (4.88m)	20' (6.1m)	24' (7.32m)
1/2"	6"	18"	12"	12"	6"	6"
	8"	16"	16"	8"	8"	8"
5/8"	6"	24"	18"	12"	12"	6"
	8"	24"	16"	16"	8"	8"

NOTES:

1. Anchor bolts to be installed at the indicated spacing and staggered as shown.
2. Design assumes floor ledger supports vertical floor load only. Design of floor diaphragm by others.
3. Design loads: 40psf (1.9 kPa) floor live load, 15psf (0.7 kPa) floor dead load.
4. Anchor bolts shall conform to the requirements of ASTM standard A307.
5. Anchor bolt connection to be installed at Dry Service Condition.

Brick Ledge Detail and Table

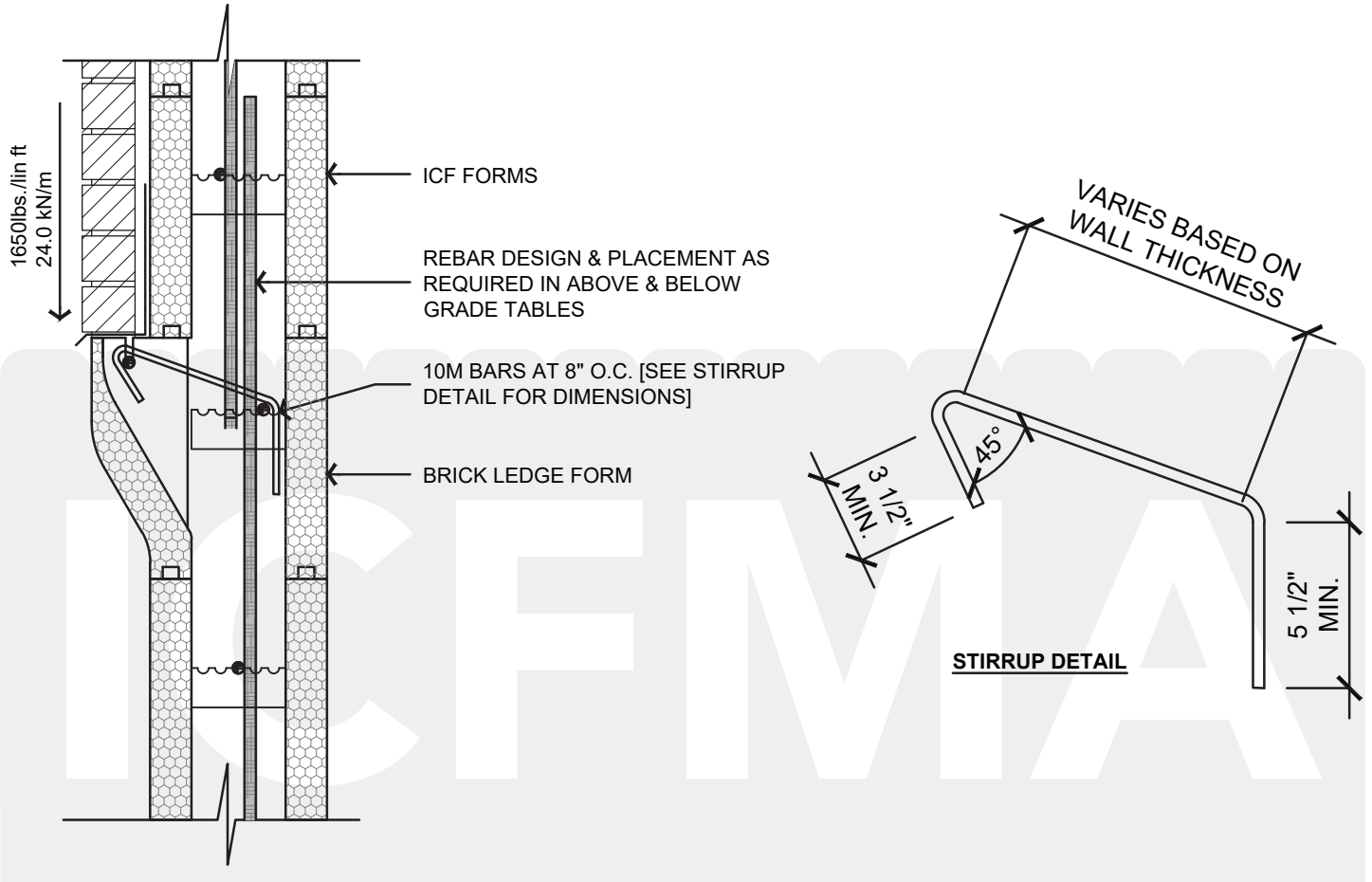

Detail C. 2. Brick Ledge Connection

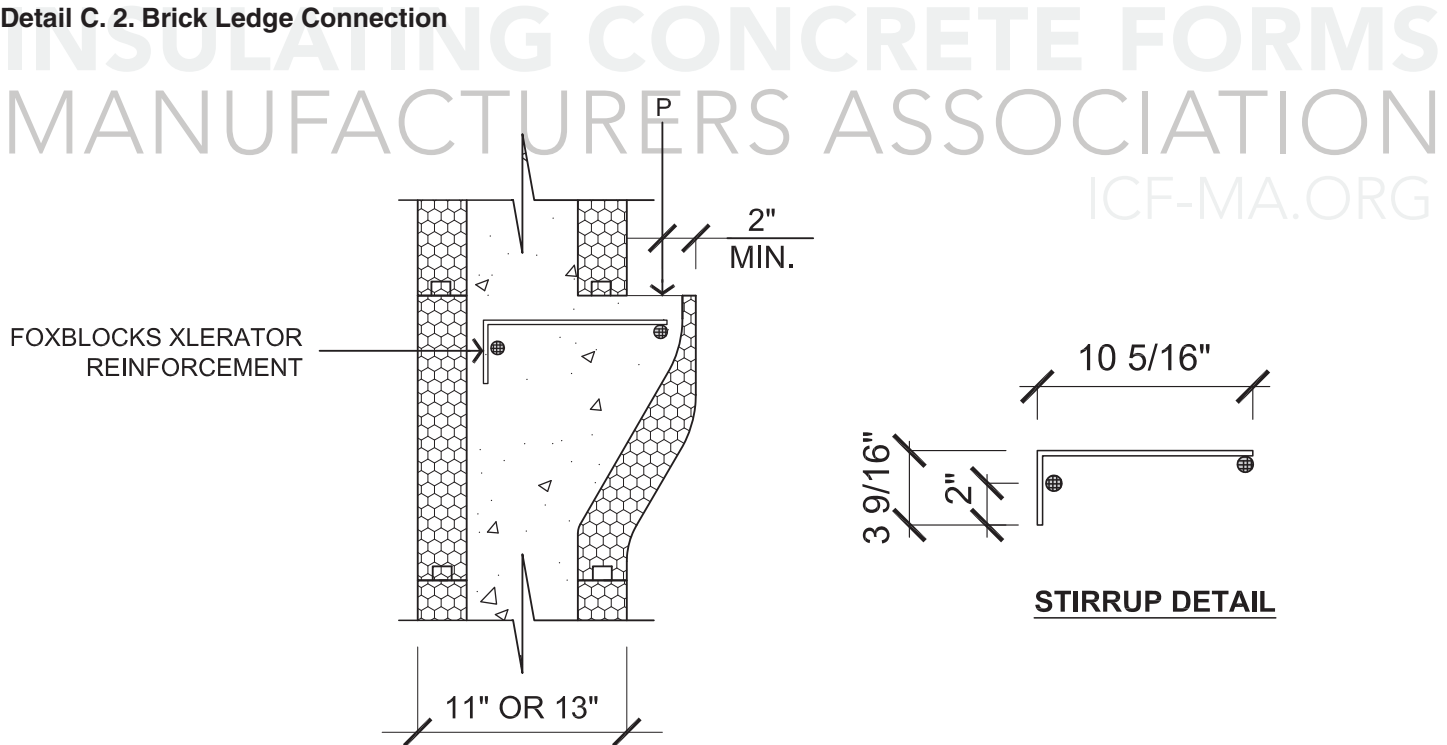

Detail C.3. Fox Blocks xLerator Ledge Reinforcement

Table C.3 Brick Ledge Load Capacity

Application		Capacity
Brick	Max 4" thick	9.6m (31'-6") high
	Max 20kN/cu.m	
Wood Floor Joists		6.4m (21') Tributary floor width
	0.7kPa (15psf) Dead Load	
	1.9kPa (40psf) Live Load	
Other	maximum factored load	24kN/m (1650 plf)

NOTES:

1. 1. Concrete Ledge reinforcement is to support floor framing and masonry veneer in conformance with the "Design Limitations"
2. 2. The concrete ledge is to support uniformly distributed loads only. It is not to support concentrated load.
3. 3. The above grade and below grade wall reinforcing tables include the effects of using the ledge to support floor framing.
4. 4. The below grade wall reinforcing tables include the effects of using the ledge to support masonry veneer.
5. 5. The maximum brick height given does not account for windows. To include the effect of windows, it is necessary to calculate an effective brick height.
6. 6. The ledge reinforcement is 10M hooked rebar as shown in Detail C.2. It is to be placed 6" or 8" on center as shown.

ICFMA

INSULATING CONCRETE FORMS
 MANUFACTURERS ASSOCIATION
 ICF-MA.ORG

Footing Details and Tables

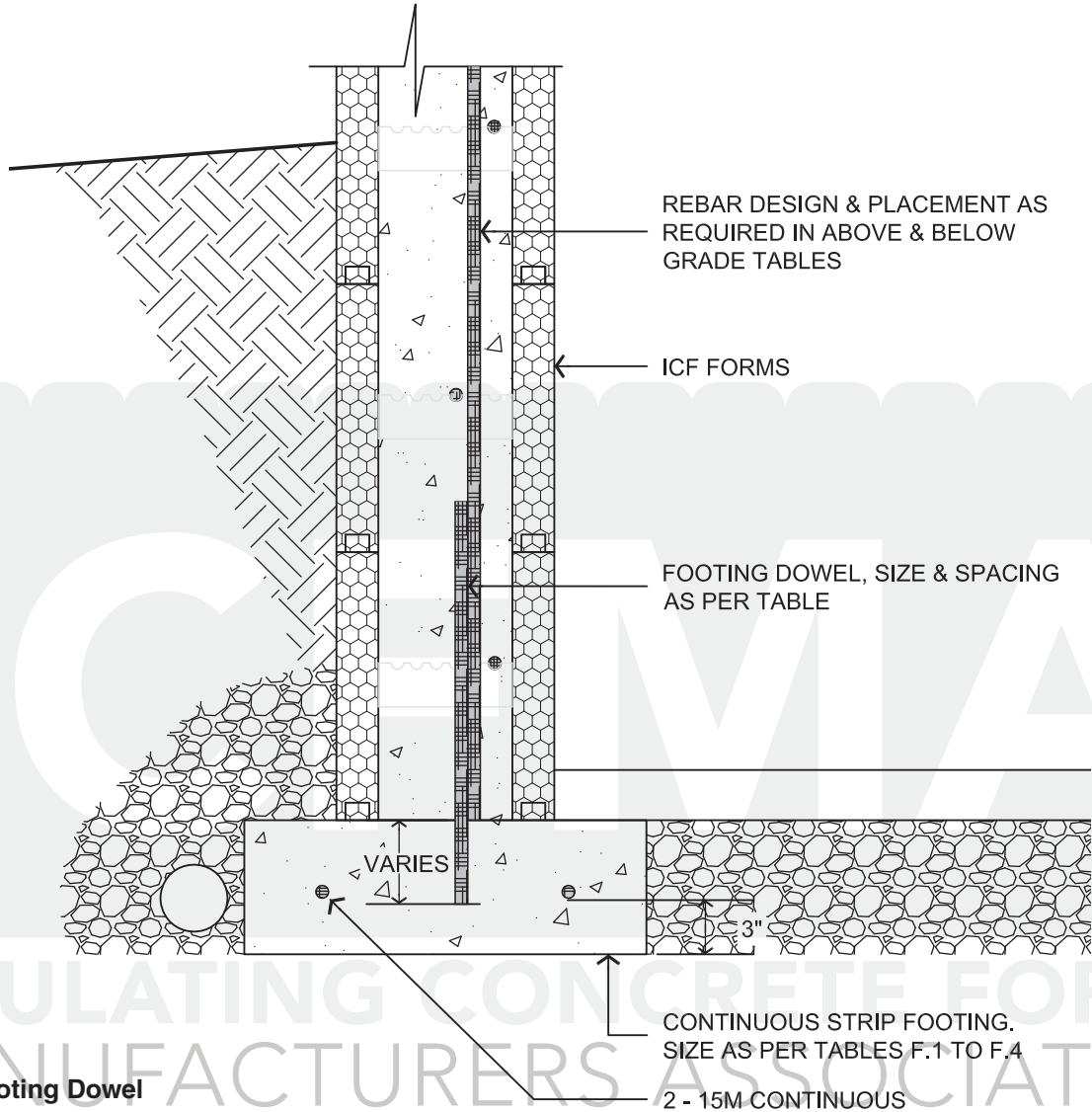

Detail F.1. Footing Dowel

Table F.1- Footing Dowels Size and Spacing

Rebar Diameter	Maximum Spacing of Vertical Footing Dowels, in				
	Backfill Height, ft (m)				
	4' (1.22m)	6' (1.83m)	8' (2.44m)	10' (3.05m)	12' (3.66)
Seismic Zone Classification: $S_a(0.2) \leq 0.25$					
10M	48"	48"	40"	8"	8"
15M	48"	48"	48"	16"	8"
Seismic Zone Classification: $S_a(0.2) \leq 1.20$					
10M	24"	24"	16"	8"	
15M	24"	24"	24"	8"	8"
Seismic Zone Classification: $S_a(0.2) \leq 1.75$					
10M	24"	24"	8"		
15M	24"	24"	16"	8"	8"

NOTES:

1. Footing Dowels to be installed as per Details F.1.
2. Provide 18" long straight dowels for $S_a(0.2) \leq 0.4$ embedded 6" into the footing.
3. Provide 30"V x 8"H bent dowels for $S_a(0.2) > 0.4$ embedded 8" into the footing.
4. Provide 30"V x 8"H bent dowels embedded 8" into the footing at shear walls locations, matching the size and spacing of vertical bars of the shear walls.

Table F.2- Minimum Exterior Strip Footing Sizes Not Supporting Roof Loads

ICF Wall Thickness, in (mm)	Minimum Footing Width x Thickness, in x in							
	Allowable Soil Bearing Pressure, psf (kPa)							
	3000 (144)		2500 (120)		2000 (96)		1500 (72)	
Two Storey - ICF Basement Walls, Wood Main Floor Walls, and Wood Second Floor Walls								
6 (150)	16"	x 6"	16"	x 6"	16"	x 6"	20"	x 6"
8 (200)	18"	x 6"	18"	x 6"	18"	x 6"	22"	x 6"
10 (250)	20"	x 6"	20"	x 6"	20"	x 6"	24"	x 6"
12 (300)	22"	x 6"	22"	x 6"	22"	x 6"	26"	x 8"
Two Storey - ICF Basement Walls, ICF Main Floor Walls, and Wood Second Floor Walls								
6 (150)	16"	x 6"	18"	x 6"	22"	x 8"	28"	x 8"
8 (200)	18"	x 6"	20"	x 6"	26"	x 8"	34"	x 10"
10 (250)	20"	x 6"	24"	x 8"	30"	x 10"	40"	x 10"
12 (300)	22"	x 8"	26"	x 8"	32"	x 10"	42"	x 12"
Two Storey - ICF Basement Walls, ICF Main Floor Walls, and ICF Second Floor Walls								
6 (150)	18"	x 8"	20"	x 8"	26"	x 10"	34"	x 10"
8 (200)	22"	x 8"	26"	x 8"	32"	x 10"	42"	x 12"
10 (250)	26"	x 8"	30"	x 10"	38"	x 12"	50"	x 14"
12 (300)	26"	x 8"	32"	x 10"	40"	x 12"	52"	x 14"
One Storey - ICF Basement Walls, and Wood Main Floor Walls								
6 (150)	16"	x 6"	16"	x 6"	16"	x 6"	16"	x 6"
8 (200)	18"	x 6"	18"	x 6"	18"	x 6"	18"	x 6"
10 (250)	20"	x 6"	20"	x 6"	20"	x 6"	20"	x 6"
12 (300)	22"	x 6"	22"	x 6"	22"	x 6"	22"	x 6"
One Storey - ICF Basement Walls, and ICF Main Floor Walls								
6 (150)	16"	x 6"	16"	x 6"	18"	x 6"	24"	x 8"
8 (200)	18"	x 6"	18"	x 6"	22"	x 8"	28"	x 8"
10 (250)	20"	x 6"	20"	x 6"	26"	x 8"	34"	x 10"
12 (300)	22"	x 8"	22"	x 8"	28"	x 8"	36"	x 10"

NOTES:

1. All footings are to be reinforced with 2-15M continuous bars, as per drawing F.1.
2. Refer to the Canadian Design Limitations for maximum floor and roof spans and loads.
3. This table does not include masonry veneer. Increase the footing width by 2" and the thickness by 1" for:
 - a. Every 12'-0" of masonry veneer for 3000 psf soil bearing capacity.
 - b. Every 10'-0" of masonry veneer for 2500psf soil bearing capacity.
 - c. Every 8'-0" of masonry veneer for 2000psf soil bearing capacity.
 - d. Every 6'-0" of masonry veneer for 1500psf soil bearing capacity.
4. The footing size for locations with $S_a(0.2) > 0.4$ to be the larger of 30" wide by 12" deep or the size shown in the table.

Table F.3- Minimum Exterior Strip Footing Sizes Supporting Roof Snow Loads ≤ 2kPa

ICF Wall Thickness, in (mm)	Minimum Footing Width x Thickness, in x in							
	Allowable Soil Bearing Pressure, psf (kPa)							
	3000 (144)		2500 (120)		2000 (96)		1500 (72)	
Two Storey - ICF Basement Walls, Wood Main Floor Walls, and Wood Second Floor Walls								
6 (150)	16"	x 6"	18"	x 6"	22"	x 8"	28"	x 8"
8 (200)	18"	x 6"	20"	x 6"	24"	x 8"	32"	x 10"
10 (250)	20"	x 6"	20"	x 6"	26"	x 8"	34"	x 10"
12 (300)	22"	x 8"	22"	x 8"	28"	x 8"	36"	x 10"
Two Storey - ICF Basement Walls, ICF Main Floor Walls, and Wood Second Floor Walls								
6 (150)	20"	x 8"	24"	x 8"	28"	x 10"	38"	x 12"
8 (200)	22"	x 8"	26"	x 10"	32"	x 10"	44"	x 12"
10 (250)	24"	x 8"	30"	x 10"	36"	x 10"	48"	x 14"
12 (300)	26"	x 8"	32"	x 10"	38"	x 12"	52"	x 14"
Two Storey - ICF Basement Walls, ICF Main Floor Walls, and ICF Second Floor Walls								
6 (150)	22"	x 8"	26"	x 10"	32"	x 10"	44"	x 12"
8 (200)	26"	x 10"	30"	x 10"	38"	x 12"	50"	x 14"
10 (250)	30"	x 10"	36"	x 12"	44"	x 14"	58"	x 16"
12 (300)	30"	x 10"	36"	x 12"	46"	x 14"	60"	x 16"
One Storey - ICF Basement Walls, and Wood Main Floor Walls								
6 (150)	16"	x 6"	16"	x 6"	18"	x 6"	24"	x 8"
8 (200)	18"	x 6"	18"	x 6"	20"	x 6"	26"	x 8"
10 (250)	20"	x 6"	20"	x 6"	22"	x 6"	28"	x 8"
12 (300)	22"	x 6"	22"	x 6"	22"	x 6"	30"	x 8"
One Storey - ICF Basement Walls, and ICF Main Floor Walls								
6 (150)	16"	x 6"	20"	x 8"	24"	x 8"	32"	x 10"
8 (200)	20"	x 8"	24"	x 8"	28"	x 10"	38"	x 10"
10 (250)	22"	x 8"	26"	x 8"	32"	x 10"	44"	x 12"
12 (300)	24"	x 8"	28"	x 10"	34"	x 10"	46"	x 12"

NOTES:

1. All footings are to be reinforced with 2-15M continuous bars, as per drawing F.1.
2. Refer to the Canadian Design Limitations for maximum floor and roof spans and loads.
3. This table does not include masonry veneer. Increase the footing width by 2" and the thickness by 1" for:
 - a. Every 12'-0" of masonry veneer for 3000 psf soil bearing capacity.
 - b. Every 10'-0" of masonry veneer for 2500psf soil bearing capacity.
 - c. Every 8'-0" of masonry veneer for 2000psf soil bearing capacity.
 - d. Every 6'-0" of masonry veneer for 1500psf soil bearing capacity.
4. The footing size for locations with $S_a(0.2) > 0.4$ to be the larger of 30" wide by 12" deep or the size shown in the table.

Table F.4- Minimum Exterior Strip Footing Sizes Supporting Roof Snow Loads $\leq 4\text{kPa}$

ICF Wall Thickness, in (mm)	Minimum Footing Width x Thickness, in x in							
	Allowable Soil Bearing Pressure, psf (kPa)							
	3000 (144)		2500 (120)		2000 (96)		1500 (72)	
Two Storey - ICF Basement Walls, Wood Main Floor Walls, and Wood Second Floor Walls								
6 (150)	18"	x 8"	22"	x 8"	26"	x 10"	36"	x 10"
8 (200)	20"	x 8"	24"	x 8"	28"	x 10"	38"	x 10"
10 (250)	20"	x 6"	24"	x 8"	30"	x 10"	40"	x 10"
12 (300)	22"	x 8"	26"	x 8"	32"	x 10"	42"	x 12"
Two Storey - ICF Basement Walls, ICF Main Floor Walls, and Wood Second Floor Walls								
6 (150)	22"	x 8"	28"	x 10"	34"	x 12"	44"	x 14"
8 (200)	26"	x 10"	30"	x 10"	38"	x 12"	50"	x 14"
10 (250)	28"	x 10"	34"	x 12"	42"	x 12"	56"	x 16"
12 (300)	30"	x 10"	36"	x 12"	44"	x 14"	58"	x 16"
Two Storey - ICF Basement Walls, ICF Main Floor Walls, and ICF Second Floor Walls								
6 (150)	26"	x 10"	30"	x 12"	38"	x 12"	50"	x 14"
8 (200)	30"	x 12"	34"	x 12"	44"	x 14"	58"	x 16"
10 (250)	34"	x 12"	40"	x 14"	50"	x 16"	66"	x 18"
12 (300)	34"	x 12"	40"	x 14"	50"	x 16"	68"	x 18"
One Storey - ICF Basement Walls, and Wood Main Floor Walls								
6 (150)	16"	x 6"	18"	x 6"	22"	x 8"	30"	x 10"
8 (200)	18"	x 6"	20"	x 6"	24"	x 8"	32"	x 10"
10 (250)	20"	x 6"	22"	x 6"	26"	x 8"	34"	x 10"
12 (300)	22"	x 8"	22"	x 8"	28"	x 8"	38"	x 10"
One Storey - ICF Basement Walls, and ICF Main Floor Walls								
6 (150)	20"	x 8"	24"	x 8"	30"	x 10"	38"	x 12"
8 (200)	22"	x 8"	28"	x 10"	34"	x 10"	44"	x 12"
10 (250)	26"	x 8"	30"	x 10"	38"	x 12"	50"	x 14"
12 (300)	26"	x 8"	32"	x 10"	40"	x 12"	52"	x 14"

NOTES:

1. All footings are to be reinforced with 2-15M continuous bars, as per drawing F.1.
2. Refer to the Canadian Design Limitations for maximum floor and roof spans and loads.
3. This table does not include masonry veneer. Increase the footing width by 2" and the thickness by 1" for:
 - a. Every 12'-0" of masonry veneer for 3000 psf soil bearing capacity.
 - b. Every 10'-0" of masonry veneer for 2500psf soil bearing capacity.
 - c. Every 8'-0" of masonry veneer for 2000psf soil bearing capacity.
 - d. Every 6'-0" of masonry veneer for 1500psf soil bearing capacity.
4. The footing size for locations with $S_a(0.2) > 0.4$ to be the larger of 30" wide by 12" deep or the size shown in the table.

Appendix A: Equivalent Spectral Response Acceleration for ICF Walls, $S_{a,ICF}$

Province and Location	$S_{a,ICF}$	Province and Location	$S_{a,ICF}$	Province and Location	$S_{a,ICF}$	Province and Location	$S_{a,ICF}$
British Columbia		Mackenzie	0.117	Ladner	0.642	Hardisty	0.043
100 Mile House	0.113	Masset	0.588	Langley	0.541	High River	0.134
Abbotsford	0.486	McBride	0.162	New Westminster	0.561	Hinton	0.175
Agassiz	0.338	McLeod Lake	0.110	North Vancouver	0.558	Jasper	0.183
Alberni	0.701	Merritt	0.175	Richmond	0.616	Alberta	
Ashcroft	0.160	Mission City	0.455	Surrey (88 Ave & 156 St.)	0.552	Keg River	0.042
Bamfield	1.010	Montrose	0.102	Vancouver (City Hall)	0.592	Lac la Biche	0.038
Beatton River	0.083	Nakusp	0.102	Vancouver (Granville & 41 Ave)	0.601	Lacombe	0.081
Bella Bella	0.231	Nanaimo	0.719	West Vancouver	0.572	Lethbridge	0.125
Bella Coola	0.172	Nelson	0.103	Vernon	0.108	Manning	0.049
Burns Lake	0.080	Ocean Falls	0.199	Victoria Region		Medicine Hat	0.060
Cache Creek	0.157	Osoyoos	0.150	Victoria (Gonzales Hts)	0.861	Peace River	0.058
Campbell River	0.482	Parksville	0.665	Victoria (Mt Tolmie)	0.853	Pincher Creek	0.195
Carmi	0.120	Penticton	0.138	Victoria	0.868	Ranfurly	0.042
Castlegar	0.100	Port Alberni	0.721	Whistler	0.315	Red Deer	0.085
Chetwynd	0.121	Port Alice	0.950	White Rock	0.601	Rocky Mountain House	0.116
Chilliwack	0.383	Port Hardy	0.533	Williams Lake	0.110	Slave Lake	0.047
Comox	0.536	Port McNeill	0.546	Youbou	0.846	Stettler	0.066
Courtenay	0.541	Port Renfrew	1.010	Alberta		Stony Plain	0.069
Cranbrook	0.138	Powell River	0.464	Athabasca	0.043	Suffield	0.068
Crescent Valley	0.101	Prince George	0.089	Banff	0.178	Taber	0.101
Crofton	0.781	Prince Rupert	0.264	Barrhead	0.064	Turner Valley	0.160
Dawson Creek	0.098	Princeton	0.204	Beaverlodge	0.102	Valleyview	0.078
Dease Lake	0.091	Qualicum Beach	0.652	Brooks	0.076	Vegreville	0.044
Dog Creek	0.140	Queen Charlotte City	1.025	Calgary	0.126	Vermilion	0.038
Duncan	0.816	Quesnel	0.088	Campsie	0.067	Wagner	0.048
Elko	0.174	Revelstoke	0.109	Camrose	0.058	Wainwright	0.040
Fernie	0.174	Salmon Arm	0.104	Canmore	0.177	Wetaskiwin	0.069
Fort Nelson	0.103	Sandspit	0.868	Cardston	0.196	Whitecourt	0.079
Fort St. John	0.094	Sechelt	0.589	Claresholm	0.147	Wimborne	0.087
Glacier	0.142	Sidney	0.823	Cold Lake	0.034	Saskatchewan	
Gold River	0.748	Smith River	0.370	Coleman	0.189	Assiniboia	0.076
Golden	0.170	Smithers	0.090	Coronation	0.048	Battrum	0.042
Grand Forks	0.108	Sooke	0.928	Cowley	0.191	Biggar	0.037
Greenwood	0.113	Squamish	0.434	Drumheller	0.077	Broadview	0.048
Hope	0.280	Stewart	0.132	Edmonton	0.062	Dafoe	0.040
Jordan River	0.980	Tahsis	0.890	Edson	0.111	Dundurn	0.039
Kamloops	0.123	Taylor	0.093	Embarras Portage	0.031	Estevan	0.073
Kaslo	0.109	Terrace	0.145	Fairview	0.071	Hudson Bay	0.034
Kelowna	0.122	Tofino	1.018	Fort MacLeod	0.158	Humboldt	0.037
Kimberley	0.130	Trail	0.101	Fort McMurray	0.034	Island Falls	0.031
Kitimat Plant	0.167	Ucluelet	1.033	Fort Saskatchewan	0.053	Kamsack	0.037
Kitimat Townsite	0.167	Vancouver Region		Fort Vermilion	0.036	Kindersley	0.039
Ladysmith	0.768	Burnaby (Simon Fraser Univ.)	0.540	Grande Prairie	0.093	Lloydminster	0.036
Langford	0.890	Cloverdale	0.560	Habay	0.045	Maple Creek	0.048
Lillooet	0.206	Haney	0.491			Meadow Lake	0.034
Lytton	0.219					Melfort	0.035

Province and Location	S _{a,ICF}
Melville	0.044
Moose Jaw	0.058
Nipawin	0.034
North Battleford	0.036
Prince Albert	0.034
Qu'Appelle	0.054
Regina	0.060
Rosetown	0.038
Saskatoon	0.037
Scott	0.037
Strasbourg	0.046
Swift Current	0.045
Uranium City	0.032
Weyburn	0.105
Yorkton	0.040
Manitoba	
Beausejour	0.033
Boissevain	0.037
Brandon	0.031
Churchill	0.032
Dauphin	0.035
Flin Flon	0.032
Gimli	0.032
Island Lake	0.033
Lac du Bonnet	0.033
Lynn Lake	0.032
Morden	0.031
Neepawa	0.031
Pine Falls	0.033
Portage la Prairie	0.032
Rivers	0.037
Sandilands	0.032
Selkirk	0.032
Split Lake	0.032
Steinbach	0.032
Swan River	0.035
The Pas	0.032
Thompson	0.032
Virden	0.041
Winnipeg	0.032
Ontario	
Ailsa Craig	0.064
Ajax	0.117
Alexandria	0.267
Alliston	0.076
Almonte	0.173
Armstrong	0.037
Arnprior	0.186

Province and Location	S _{a,ICF}
Atikokan	0.039
Attawapiskat	0.043
Aurora	0.087
Bancroft	0.105
Barrie	0.077
Barriefield	0.110
Beaverton	0.082
Belleville	0.105
Belmont	0.073
Kitchenuhmay-kooisib (Big Trout Lake)	0.033
CFB Borden	0.075
Bracebridge	0.084
Bradford	0.081
Brampton	0.096
Brantford	0.089
Brighton	0.106
Brockville	0.151
Burk's Falls	0.096
Burlington	0.143
Cambridge	0.084
Campbellford	0.097
Cannington	0.084
Carleton Place	0.164
Cavan	0.092
Centralia	0.064
Chapleau	0.050
Chatham	0.070
Chesley	0.062
Clinton	0.061
Cobocónk	0.086
Cobourg	0.106
Cochrane	0.122
Colborne	0.106
Collingwood	0.070
Cornwall	0.266
Corunna	0.060
Deep River	0.192
Deseronto	0.106
Dorchester	0.072
Dorion	0.035
Dresden	0.067
Dryden	0.040
Dundalk	0.069
Dunnville	0.127
Durham	0.065
Dutton	0.072
Earlton	0.108
Edison	0.039

Province and Location	S _{a,ICF}
Elliot Lake	0.054
Elmvale	0.074
Embro	0.072
Englehart	0.104
Espanola	0.063
Exeter	0.063
Fenelon Falls	0.086
Fergus	0.075
Forest	0.061
Fort Erie	0.162
Fort Erie (Ridgeway)	0.160
Fort Frances	0.036
Gananoque	0.119
Geraldton	0.036
Glencoe	0.068
Goderich	0.059
Gore Bay	0.055
Graham	0.040
Gravenhurst (Muskoka Airport)	0.082
Grimsby	0.158
Guelph	0.082
Guthrie	0.078
Haileybury	0.125
Haldimand (Caledonia)	0.119
Haldimand (Hagersville)	0.097
Haliburton	0.095
Halton Hills (Georgetown)	0.090
Hamilton	0.140
Hanover	0.063
Hastings	0.096
Hawkesbury	0.238
Hearst	0.048
Honey Harbour	0.076
Hornepayne	0.043
Huntsville	0.091
Ingersoll	0.073
Iroquois Falls	0.110
Jellicoe	0.035
Kapuskasing	0.064
Kemptville	0.209
Kenora	0.036
Killaloe	0.148
Kincardine	0.058
Kingston	0.110
Kinmount	0.089
Kirkland Lake	0.095
Kitchener	0.077

Province and Location	S _{a,ICF}
Lakefield	0.091
Lansdowne House	0.035
Leamington	0.070
Lindsay	0.087
Lion's Head	0.062
Listowel	0.066
London	0.070
Lucan	0.065
Maitland	0.159
Markdale	0.066
Markham	0.103
Martin	0.040
Matheson	0.091
Mattawa	0.215
Midland	0.075
Milton	0.107
Milverton	0.067
Minden	0.089
Mississauga	0.121
Mississauga (Lester B. Pearson Int'l Airport)	0.109
Mississauga (Port Credit)	0.134
Mitchell	0.065
Moosonee	0.051
Morrisburg	0.256
Mount Forest	0.067
Nakina	0.036
Nanticoke (Jarvis)	0.090
Nanticoke (Port Dover)	0.085
Napanee	0.106
New Liskeard	0.121
Newcastle	0.107
Newcastle (Bowmanville)	0.107
Newmarket	0.085
Niagara Falls	0.166
North Bay	0.141
Norwood	0.094
Oakville	0.140
Orangeville	0.076
Orillia	0.079
Oshawa	0.108
Ottawa (City Hall)	0.213
Ottawa (Barrhaven)	0.208
Ottawa (Kanata)	0.197
Ottawa (M-C Int'l Airport)	0.215
Ottawa (Orleans)	0.226
Owen Sound	0.064

Province and Location	S _{a,ICF}
Pagwa River	0.040
Paris	0.084
Parkhill	0.063
Parry Sound	0.079
Pelham (Fonthill)	0.162
Pembroke	0.189
Penetanguishene	0.074
Perth	0.140
Petawawa	0.189
Peterborough	0.092
Petrolia	0.062
Pickering (Dunbarton)	0.121
Picton	0.104
Plattsville	0.075
Point Alexander	0.193
Port Burwell	0.079
Port Colborne	0.157
Port Elgin	0.060
Port Hope	0.106
Port Perry	0.091
Port Stanley	0.075
Prescott	0.178
Princeton	0.079
Raith	0.038
Rayside-Balfour (Chelmsford)	0.072
Red Lake	0.038
Renfrew	0.179
Richmond Hill	0.095
Rockland	0.239
Sarnia	0.059
Sault Ste. Marie	0.044
Schreiber	0.035
Seaforth	0.062
Shelburne	0.072
Simcoe	0.084
Sioux Lookout	0.041
Smiths Falls	0.151
Smithville	0.156
Smooth Rock Falls	0.112
South River	0.106
Southampton	0.060
St. Catharines	0.165
St. Mary's	0.068
St. Thomas	0.073
Stirling	0.100
Stratford	0.069
Strathroy	0.066
Sturgeon Falls	0.113

Province and Location	S _{a,ICF}
Sudbury	0.076
Sundridge	0.103
Tavistock	0.071
Temagami	0.135
Thamesford	0.071
Thedford	0.062
Thunder Bay	0.035
Tillsonburg	0.077
Timmins	0.075
Timmins (Porcupine)	0.081
Etobicoke	0.109
North York	0.110
Scarborough	0.121
Toronto (City Hall)	0.135
Trenton	0.105
Trout Creek	0.116
Uxbridge	0.089
Vaughan (Woodbridge)	0.096
Vittoria	0.083
Walkerton	0.062
Wallaceburg	0.064
Waterloo	0.075
Watford	0.064
Wawa	0.043
Welland	0.161
West Lorne	0.072
Whitby	0.114
Whitby (Brooklin)	0.102
White River	0.041
Warton	0.062
Windsor	0.063
Wingham	0.061
Woodstock	0.075
Wyoming	0.061
Quebec	
Acton-Vale	0.155
Alma	0.356
Amos	0.078
Asbestos	0.137
Aylmer	0.203
Baie-Comeau	0.207
Baie-Saint-Paul	0.735
Beauport	0.239
Bedford	0.185
Beloeil	0.244
Brome	0.149
Brossard	0.266
Buckingham	0.232

Province and Location	S _{a,ICF}
Campbell's Bay	0.192
Chambly	0.254
Coaticook	0.129
Contrecoeur	0.226
Cowansville	0.161
Deux-Montagnes	0.270
Dolbeau	0.230
Drummondville	0.160
Farnham	0.187
Fort-Coulonge	0.193
Gagnon	0.060
Gaspé	0.090
Gatineau	0.214
Gracefield	0.207
Granby	0.161
Harrington-Harbour	0.056
Havre-St-Pierre	0.127
Hemmingford	0.253
Hull	0.210
Iberville	0.243
Inukjuak	0.040
Joliette	0.219
Kuujuuaq	0.054
Kuujuarapik	0.035
La Pocatière	0.685
La-Malbaie	0.785
La-Tuque	0.137
Lac-Mégantic	0.130
Lachute	0.242
Lennoxville	0.129
Léry	0.273
Loretteville	0.236
Louiseville	0.184
Magog	0.133
Malartic	0.092
Maniwaki	0.208
Masson	0.235
Matane	0.218
Mont-Joli	0.208
Mont-Laurier	0.204
Montmagny	0.278
Montreal Region	
Beaconsfield	0.273
Dorval	0.272
Laval	0.270
Montreal (City Hall)	0.270
Montreal-Est	0.266
Montreal-Nord	0.269

Province and Location	S _{a,ICF}
Outremont	0.271
Pierrefonds	0.272
St-Lambert	0.268
St-Laurent	0.271
Ste-Anne-de-Bellevue	0.273
Verdun	0.270
Nicolet (Gentilly)	0.183
Nitchequon	0.047
Noranda	0.088
Perce	0.084
Pincourt	0.273
Plessisville	0.155
Port-Cartier	0.167
Puvirnituq	0.061
Quebec City Region	
Ancienne-Lorette	0.231
Levis	0.233
Quebec	0.233
Sillery	0.230
Ste-Foy	0.231
Richmond	0.140
Rimouski	0.200
Riviere-du-Loup	0.526
Roberval	0.312
Rock-Island	0.133
Rosemere	0.268
Rouyn	0.089
Saguenay	0.359
Saguenay (Bagotville)	0.363
Saguenay (Jonquière)	0.362
Saguenay (Kenogami)	0.362
Saint-Eustache	0.269
Saint-Jean-sur-Richelieu	0.244
Salaberry-de-Valleyfield	0.273
Schefferville	0.042
Senneterre	0.083
Sept-Iles	0.155
Shawinigan	0.167
Shawville	0.191
Sherbrooke	0.129
Sorel	0.200
St-Felicien	0.232
St-Georges-de-Cacouna	0.389
St-Hubert	0.264
Saint-Hubert-de-Riviere-du-Loup	0.239
St-Hyacinthe	0.187

Province and Location	S _{a,ICF}
St-JerOme	0.250
St-Jovite	0.207
Quebec	
St-Lazare-Hudson	0.271
St-Nicolas	0.223
Ste-Agathe-des-Monts	0.209
Sutton	0.150
Tadoussac	0.318
Temiscaming	0.372
Terrebonne	0.265
Theftord Mines	0.142
Thurso	0.232
Trois-Rivieres	0.184
Val-d'Or	0.093
Varenes	0.261
Vercheres	0.249
Victoriaville	0.149
Ville-Marie	0.142
Wakefield	0.201
Waterloo	0.147
Windsor	0.134
New Brunswick	
Alma	0.096
Bathurst	0.125
Campbellton	0.132
Edmundston	0.150
Fredericton	0.126
Gagetown	0.119
Grand Falls	0.148
Miramichi	0.124
Moncton	0.100
Oromocto	0.125
Sackville	0.093
Saint Andrews	0.396
Saint George	0.264
Saint John	0.121
Shippagan	0.096
St. Stephen	0.354
Woodstock	0.128
Nova Scotia	
Amherst	0.089
Antigonish	0.076
Bridgewater	0.086
Canso	0.085
Debert	0.080
Digby	0.105
Greenwood (CFB)	0.090
Dartmouth	0.082

Province and Location	S _{a,ICF}
Halifax	0.082
Kentville	0.087
Liverpool	0.086
Lockeport	0.087
Louisburg	0.089
Lunenburg	0.085
New Glasgow	0.077
North Sydney	0.081
Pictou	0.076
Port Hawkesbury	0.079
Springhill	0.085
Stewiacke	0.081
Sydney	0.083
Tatamagouche	0.079
Truro	0.080
Wolfville	0.086
Yarmouth	0.094
Prince Edward Island	
Charlottetown	0.077
Souris	0.073
Summerside	0.089
Tignish	0.090
Newfoundland	
Argentia	0.079
Bonavista	0.067
Buchans	0.064
Cape Harrison	0.087
Cape Race	0.085
Channel-Port aux Basques	0.071
Corner Brook	0.062
Gander	0.064
Grand Bank	0.090
Grand Falls	0.064
Happy Valley - Goose Bay	0.050
Labrador City	0.052
St. Anthony	0.057
St. John's	0.073
Stephenville	0.064
Twin Falls	0.047
Wabana	0.072
Wabush	0.052



Appendix B: Climatic Design Data

Province and Location	Elev., m	Design Temperature				De- gree- Days Below 18°C	15 Min. Rain, mm	One Day Rain, 1/50, mm	Ann. Rain, mm	Moist. Index	Ann. Tot. Ppn., mm	Driv- ing Rain Wind Pres- sures, Pa, 1/5	Snow Load, kPa, 1/50		Hourly Wind Pressures, kPa	
		January		July 2.5%									S _s	S _r	1/10	1/50
		2.5% °C	1% °C	Dry °C	Wet °C											
British Columbia																
100 Mile House	1040	-30	-32	29	17	5030	10	48	300	0.44	425	60	2.6	0.3	0.27	0.35
Abbotsford	70	-8	-10	29	20	2860	12	112	1525	1.59	1600	160	2.0	0.3	0.34	0.44
Agassiz	15	-9	-11	31	21	2750	8	128	1650	1.71	1700	160	2.4	0.7	0.36	0.47
Alberni	12	-5	-8	31	19	3100	10	144	1900	2.00	2000	220	2.6	0.4	0.25	0.32
Ashcroft	305	-24	-27	34	20	3700	10	37	250	0.25	300	80	1.7	0.1	0.29	0.38
Bamfield	20	-2	-4	23	17	3080	13	170	2870	2.96	2890	280	1.0	0.4	0.39	0.50
Beaton River	840	-37	-39	26	18	6300	15	64	330	0.53	450	80	3.3	0.1	0.23	0.30
Bella Bella	25	-5	-7	23	18	3180	13	145	2715	2.82	2800	350	2.6	0.8	0.39	0.50
Bella Coola	40	-14	-18	27	19	3560	10	140	1500	1.85	1700	350	4.5	0.8	0.30	0.39
Burns Lake	755	-31	-34	26	17	5450	12	54	300	0.56	450	100	3.4	0.2	0.30	0.39
Cache Creek	455	-24	-27	34	20	3700	10	37	250	0.25	300	80	1.7	0.2	0.30	0.39
Campbell River	20	-5	-7	26	18	3000	10	116	1500	1.59	1600	260	2.8	0.4	0.40	0.52
Carmi	845	-24	-26	31	19	4750	10	64	325	0.38	550	60	3.6	0.2	0.29	0.38
Castlegar	430	-18	-20	32	20	3580	10	54	560	0.64	700	60	4.2	0.1	0.27	0.34
Chetwynd	605	-35	-38	27	18	5500	15	70	400	0.58	625	60	2.4	0.2	0.31	0.40
Chilliwack	10	-9	-11	30	20	2780	8	139	1625	1.68	1700	160	2.2	0.3	0.36	0.47
Comox	15	-7	-9	27	18	3100	10	106	1175	1.28	1200	260	2.4	0.4	0.40	0.52
Courtenay	10	-7	-9	28	18	3100	10	106	1400	1.49	1450	260	2.4	0.4	0.40	0.52
Cranbrook	910	-26	-28	32	18	4400	12	59	275	0.30	400	100	3.0	0.2	0.25	0.33
Crescent Valley	585	-18	-20	31	20	3650	10	54	675	0.75	850	80	4.2	0.1	0.25	0.33
Crofton	5	-4	-6	28	19	2880	8	86	925	1.06	950	160	1.8	0.2	0.31	0.40
Dawson Creek	665	-38	-40	27	18	5900	18	75	325	0.49	475	100	2.5	0.2	0.31	0.40
Dease Lake	800	-37	-40	24	15	6730	10	45	265	0.55	425	380	2.8	0.1	0.23	0.30
Dog Creek	450	-28	-30	29	17	4800	10	48	275	0.41	375	100	1.8	0.2	0.27	0.35
Duncan	10	-6	-8	28	19	2980	8	103	1000	1.13	1050	180	1.8	0.4	0.30	0.39
Elko	1065	-28	-31	30	19	4600	13	64	440	0.48	650	100	3.6	0.2	0.31	0.40
Fernie	1010	-27	-30	30	19	4750	13	118	860	0.88	1175	100	4.5	0.2	0.31	0.40
Fort Nelson	465	-39	-42	28	18	6710	15	70	325	0.56	450	80	2.4	0.1	0.23	0.30
Fort St. John	685	-35	-37	26	18	5750	15	72	320	0.50	475	100	2.8	0.1	0.30	0.39
Glacier	1145	-27	-30	27	17	5800	10	70	625	0.83	1500	80	9.4	0.2	0.25	0.32
Gold River	120	-8	-11	31	18	3230	13	200	2730	2.80	2850	250	2.8	0.6	0.25	0.32
Golden	790	-27	-30	30	17	4750	10	55	325	0.57	500	100	3.7	0.2	0.27	0.35
Grand Forks	565	-19	-22	34	20	3820	10	48	390	0.47	475	80	2.8	0.1	0.31	0.40
Greenwood	745	-20	-23	34	20	4100	10	64	430	0.51	550	80	3.6	0.1	0.31	0.40
Hope	40	-13	-15	31	20	3000	8	139	1825	1.88	1900	140	2.8	0.7	0.48	0.63
Jordan River	20	-1	-3	22	17	2900	12	170	2300	2.37	2370	250	1.2	0.4	0.43	0.55
Kamloops	355	-23	-25	34	20	3450	13	42	225	0.23	275	80	1.8	0.2	0.31	0.40
Kaslo	545	-17	-20	30	19	3830	10	55	660	0.82	850	80	2.8	0.1	0.24	0.31

Council, National R. National Building Code 2015. National Research Council.

Province and Location	Elev., m	Design Temperature				De- gree- Days Below 18°C	15 Min. Rain, mm	One Day Rain, 1/50, mm	Ann. Rain, mm	Moist. Index	Ann. Tot. Ppn., mm	Driv- ing Rain Wind Pres- sures, Pa, 1/5	Snow Load, kPa, 1/50		Hourly Wind Pressures, kPa	
		January		July 2.5%									S _s	S _r	1/10	1/50
		2.5% °C	1% °C	Dry °C	Wet °C											
Kelowna	350	-17	-20	33	20	3400	12	43	260	0.29	325	80	1.7	0.1	0.31	0.40
Kimberley	1090	-25	-27	31	18	4650	12	59	350	0.38	500	100	3.0	0.2	0.25	0.33
Kitimat Plant	15	-16	-18	25	16	3750	13	193	2100	2.19	2500	220	5.5	0.8	0.37	0.48
Kitimat Townsite	130	-16	-18	24	16	3900	13	171	1900	2.00	2300	220	6.5	0.8	0.37	0.48
Ladysmith	80	-7	-9	27	19	3000	8	97	1075	1.20	1160	180	2.4	0.4	0.31	0.40
Langford	80	-4	-6	27	19	2750	9	135	1095	1.22	1125	220	1.8	0.3	0.31	0.40
Lillooet	245	-21	-23	34	20	3400	10	70	300	0.31	350	100	2.1	0.1	0.34	0.44
Lytton	325	-17	-20	35	20	3300	10	70	330	0.33	425	80	2.8	0.3	0.33	0.43
Mackenzie	765	-34	-38	27	17	5550	10	50	350	0.54	650	60	5.1	0.2	0.25	0.32
Masset	10	-5	-7	17	15	3700	13	80	1350	1.54	1400	400	1.8	0.4	0.48	0.61
McBride	730	-29	-32	29	18	4980	13	54	475	0.64	650	60	4.3	0.2	0.27	0.35
McLeod Lake	695	-35	-37	27	17	5450	10	50	350	0.54	650	60	4.1	0.2	0.25	0.32
Merritt	570	-24	-27	34	20	3900	8	54	240	0.24	310	80	1.8	0.3	0.34	0.44
Mission City	45	-9	-11	30	20	2850	13	123	1650	1.71	1700	160	2.4	0.3	0.33	0.43
Montrose	615	-16	-18	32	20	3600	10	54	480	0.56	700	60	4.1	0.1	0.27	0.35
Nakusp	445	-20	-22	31	20	3560	10	60	650	0.78	850	60	4.4	0.1	0.25	0.33
Nanaimo	15	-6	-8	27	19	3000	10	91	1000	1.13	1050	200	2.1	0.4	0.39	0.50
Nelson	600	-18	-20	31	20	3500	10	59	460	0.57	700	60	4.2	0.1	0.25	0.33
Ocean Falls	10	-10	-12	23	17	3400	13	260	4150	4.21	4300	350	3.9	0.8	0.46	0.59
Osoyoos	285	-14	-17	35	21	3100	10	48	275	0.28	310	60	1.1	0.1	0.31	0.40
Parksville	40	-6	-8	26	19	3200	10	91	1200	1.31	1250	200	2.0	0.4	0.39	0.50
Penticton	350	-15	-17	33	20	3350	10	48	275	0.28	300	60	1.3	0.1	0.35	0.45
Port Alberni	15	-5	-8	31	19	3100	10	161	1900	2.00	2000	240	2.6	0.4	0.25	0.32
Port Alice	25	-3	-6	26	17	3010	13	200	3300	3.38	3340	220	1.1	0.4	0.25	0.32
Port Hardy	5	-5	-7	20	16	3440	13	150	1775	1.92	1850	220	0.9	0.4	0.40	0.52
Port McNeill	5	-5	-7	22	17	3410	13	128	1750	1.89	1850	260	1.1	0.4	0.40	0.52
Port Renfrew	20	-3	-5	24	17	2900	13	200	3600	3.64	3675	270	1.1	0.4	0.40	0.52
Powell River	10	-7	-9	26	18	3100	10	80	1150	1.27	1200	220	1.7	0.4	0.39	0.51
Prince George	580	-32	-36	28	18	4720	15	54	425	0.58	600	80	3.4	0.2	0.29	0.37
Prince Rupert	20	-13	-15	19	15	3900	13	160	2750	2.84	2900	240	1.9	0.4	0.42	0.54
Princeton	655	-24	-29	33	19	4250	10	43	235	0.35	350	80	2.9	0.6	0.28	0.36
Qualicum Beach	10	-7	-9	27	19	3200	10	96	1200	1.31	1250	200	2.0	0.4	0.41	0.53
Queen Charlotte City	35	-6	-8	21	16	3520	13	110	1300	1.47	1350	360	1.8	0.4	0.48	0.61
Quesnel	475	-31	-33	30	17	4650	10	50	380	0.51	525	80	3.0	0.1	0.24	0.31
Revelstoke	440	-20	-23	31	19	4000	13	55	625	0.80	950	80	7.2	0.1	0.25	0.32
Salmon Arm	425	-19	-24	33	21	3650	13	48	400	0.47	525	80	3.5	0.1	0.30	0.39
Sandspit	5	-4	-6	18	15	3450	13	86	1300	1.47	1350	500	1.8	0.4	0.60	0.78
Sechelt	25	-6	-8	27	20	2680	10	75	1140	1.27	1200	160	1.8	0.4	0.37	0.48
Sidney	10	-4	-6	26	18	2850	8	96	825	0.97	850	160	1.1	0.2	0.33	0.42
Smith River	660	-45	-47	26	17	7100	10	64	300	0.58	500	40	2.8	0.1	0.23	0.30

Council, National R. National Building Code 2015. National Research Council.

Province and Location	Elev., m	Design Temperature				De- gree- Days Below 18°C	15 Min. Rain, mm	One Day Rain, 1/50, mm	Ann. Rain, mm	Moist. Index	Ann. Tot. Ppn., mm	Driv- ing Rain Wind Pres- sures, Pa, 1/5	Snow Load, kPa, 1/50		Hourly Wind Pressures, kPa	
		January		July 2.5%									S _s	S _r	1/10	1/50
		2.5% °C	1% °C	Dry °C	Wet °C											
Smithers	500	-29	-31	26	17	5040	13	60	325	0.60	500	120	3.5	0.2	0.31	0.40
Sooke	20	-1	-3	21	16	2900	9	130	1250	1.37	1280	220	1.3	0.3	0.37	0.48
Squamish	5	-9	-11	29	20	2950	10	140	2050	2.12	2200	160	2.8	0.7	0.39	0.50
Stewart	10	-17	-20	25	16	4350	13	135	1300	1.47	1900	180	7.9	0.8	0.28	0.36
Tahsis	25	-4	-6	26	18	3150	13	200	3845	3.91	3900	300	1.1	0.4	0.26	0.34
Taylor	515	-35	-37	26	18	5720	15	72	320	0.49	450	100	2.3	0.1	0.31	0.40
Terrace	60	-19	-21	27	17	4150	13	120	950	1.08	1150	200	5.4	0.6	0.28	0.36
Tofino	10	-2	-4	20	16	3150	13	193	3275	3.36	3300	300	1.1	0.4	0.53	0.68
Trail	440	-14	-17	33	20	3600	10	54	580	0.65	700	60	4.1	0.1	0.27	0.35
Ucluelet	5	-2	-4	18	16	3120	13	180	3175	3.26	3200	280	1.0	0.4	0.53	0.68
Vancouver Region																
Burnaby (Simon Fraser Univ.)	330	-7	-9	25	17	3100	10	150	1850	1.93	1950	160	2.9	0.7	0.36	0.47
Cloverdale	10	-8	-10	29	20	2700	10	112	1350	1.44	1400	160	2.5	0.2	0.34	0.44
Haney	10	-9	-11	30	20	2840	10	134	1800	1.86	1950	160	2.4	0.2	0.34	0.44
Ladner	3	-6	-8	27	19	2600	10	80	1000	1.14	1050	160	1.3	0.2	0.36	0.46
Langley	15	-8	-10	29	20	2700	10	112	1450	1.53	1500	160	2.4	0.2	0.34	0.44
New Westminster	10	-8	-10	29	19	2800	10	134	1500	1.59	1575	160	2.3	0.2	0.34	0.44
North Vancouver	135	-7	-9	26	19	2910	12	150	2000	2.07	2100	160	3.0	0.3	0.35	0.45
Richmond	5	-7	-9	27	19	2800	10	86	1070	1.20	1100	160	1.5	0.2	0.35	0.45
Surrey (88 Ave & 156 St.)	90	-8	-10	29	20	2750	10	128	1500	1.58	1575	160	2.4	0.3	0.34	0.44
Vancouver (City Hall)	40	-7	-9	28	20	2825	10	112	1325	1.44	1400	160	1.8	0.2	0.35	0.45
Vancouver (Granville & 41 Ave)	120	-6	-8	28	20	2925	10	107	1325	1.44	1400	160	1.9	0.3	0.35	0.45
West Vancouver	45	-7	-9	28	19	2950	12	150	1600	1.69	1700	160	2.4	0.2	0.37	0.48
Vernon	405	-20	-23	33	20	3600	13	43	350	0.41	400	80	2.2	0.1	0.31	0.40
Victoria Region																
Victoria (Gonzales Hts)	65	-4	-6	24	17	2700	9	91	600	0.82	625	220	1.5	0.3	0.44	0.57
Victoria (Mt Tolmie)	125	-6	-8	24	16	2700	9	91	775	0.96	800	220	2.1	0.3	0.48	0.63
Victoria	10	-4	-6	24	17	2650	8	91	800	0.98	825	220	1.1	0.2	0.44	0.57
Whistler	665	-17	-20	30	20	4180	10	85	845	0.99	1215	160	9.5	0.9	0.25	0.32
White Rock	30	-5	-7	25	20	2620	10	80	1065	1.17	1100	160	2.0	0.2	0.34	0.44
Williams Lake	615	-30	-33	29	17	4400	10	48	350	0.47	425	80	2.4	0.2	0.27	0.35
Youbou	200	-5	-8	31	19	3050	10	161	2000	2.09	2100	200	3.5	0.7	0.25	0.32
Alberta																
Athabasca	515	-35	-38	27	19	6000	18	86	370	0.58	480	80	1.5	0.1	0.28	0.36
Banff	1400	-31	-33	27	16	5500	18	65	300	0.58	500	120	3.3	0.1	0.25	0.32
Barrhead	645	-33	-36	27	19	5740	20	86	375	0.58	475	100	1.7	0.1	0.34	0.44

Council, National R. National Building Code 2015. National Research Council.

Province and Location	Elev., m	Design Temperature				De- gree- Days Below 18°C	15 Min. Rain, mm	One Day Rain, 1/50, mm	Ann. Rain, mm	Moist. Index	Ann. Tot. Ppn., mm	Driv- ing Rain Wind Pres- sures, Pa, 1/5	Snow Load, kPa, 1/50		Hourly Wind Pressures, kPa	
		January		July 2.5%									S _s	S _f	1/10	1/50
		2.5% °C	1% °C	Dry °C	Wet °C											
Beaverlodge	730	-36	-39	28	18	5700	20	86	315	0.49	470	100	2.4	0.1	0.28	0.36
Brooks	760	-32	-34	32	20	4880	18	86	260	0.26	340	220	1.2	0.1	0.40	0.52
Calgary	1045	-30	-32	28	17	5000	23	103	325	0.37	425	220	1.1	0.1	0.37	0.48
Campsie	660	-33	-36	27	19	5750	20	86	375	0.58	475	100	1.7	0.1	0.34	0.44
Camrose	740	-33	-35	29	19	5500	20	86	355	0.54	470	160	2.0	0.1	0.30	0.39
Canmore	1320	-31	-33	28	17	5400	18	86	325	0.57	500	120	3.2	0.1	0.29	0.37
Cardston	1130	-29	-32	30	19	4700	20	108	340	0.38	550	140	1.5	0.1	0.56	0.72
Claresholm	1030	-30	-32	30	18	4680	15	97	310	0.35	440	200	1.3	0.1	0.45	0.58
Cold Lake	540	-35	-38	28	19	5860	18	81	320	0.53	430	140	1.7	0.1	0.29	0.38
Coleman	1320	-31	-34	29	18	5210	15	86	400	0.46	550	120	2.7	0.3	0.48	0.63
Coronation	790	-32	-34	30	19	5640	20	92	300	0.45	400	200	1.9	0.1	0.29	0.37
Cowley	1175	-29	-32	29	18	4810	15	92	310	0.36	525	140	1.6	0.1	0.78	1.01
Drumheller	685	-32	-34	30	18	5050	20	86	300	0.39	375	220	1.2	0.1	0.34	0.44
Edmonton	645	-30	-33	28	19	5120	23	97	360	0.48	460	160	1.7	0.1	0.35	0.45
Edson	920	-34	-37	27	18	5750	18	81	450	0.63	570	100	2.1	0.1	0.36	0.46
Embarras Portage	220	-41	-43	28	19	7100	12	81	250	0.56	390	80	2.2	0.1	0.29	0.37
Fairview	670	-37	-40	27	18	5840	15	86	330	0.51	450	100	2.4	0.1	0.27	0.35
Fort MacLeod	945	-30	-32	31	19	4600	16	97	300	0.35	425	180	1.2	0.1	0.53	0.68
Fort McMurray	255	-38	-40	28	19	6250	13	86	340	0.52	460	60	1.5	0.1	0.27	0.35
Fort Saskatchewan	610	-32	-35	28	19	5420	20	86	350	0.49	425	140	1.6	0.1	0.33	0.43
Fort Vermilion	270	-41	-43	28	18	6700	13	70	250	0.53	380	60	2.1	0.1	0.23	0.30
Grande Prairie	650	-36	-39	27	18	5790	20	86	315	0.49	450	120	2.2	0.1	0.33	0.43
Habay	335	-41	-43	28	18	6750	13	70	275	0.54	425	60	2.4	0.1	0.23	0.30
Hardisty	615	-33	-36	30	19	5640	20	81	325	0.48	425	140	1.7	0.1	0.28	0.36
High River	1040	-31	-32	28	17	4900	18	97	300	0.36	425	200	1.3	0.1	0.50	0.65
Hinton	990	-34	-38	27	17	5500	13	81	375	0.55	500	100	2.6	0.1	0.36	0.46
Jasper	1060	-31	-34	28	17	5300	12	76	300	0.52	400	80	3.0	0.1	0.25	0.32
Keg River	420	-40	-42	28	18	6520	13	70	310	0.54	450	80	2.4	0.1	0.23	0.30
Lac la Biche	560	-35	-38	28	19	6100	15	86	375	0.58	475	80	1.6	0.1	0.28	0.36
Lacombe	855	-33	-36	28	19	5500	23	92	350	0.53	450	180	1.9	0.1	0.31	0.40
Lethbridge	910	-30	-32	31	19	4500	20	97	250	0.26	390	200	1.2	0.1	0.51	0.66
Manning	465	-39	-41	27	18	6300	13	76	280	0.49	390	80	2.3	0.1	0.23	0.30
Medicine Hat	705	-31	-34	32	19	4540	23	92	250	0.25	325	220	1.1	0.1	0.37	0.48
Peace River	330	-37	-40	27	18	6050	15	81	300	0.50	390	100	2.2	0.1	0.25	0.32
Pincher Creek	1130	-29	-32	29	18	4740	16	103	325	0.37	575	140	1.5	0.1	0.75	0.96
Ranfurly	670	-34	-37	29	19	5700	18	92	325	0.50	420	100	1.9	0.1	0.28	0.36
Red Deer	855	-32	-35	28	19	5550	20	97	375	0.54	475	200	1.8	0.1	0.31	0.40
Rocky Mountain House	985	-32	-34	27	18	5640	20	92	425	0.59	550	120	1.9	0.1	0.28	0.36
Slave Lake	590	-35	-38	26	19	5850	15	81	380	0.62	500	80	1.9	0.1	0.29	0.37
Stettler	820	-32	-34	30	19	5300	20	97	370	0.53	450	200	1.9	0.1	0.28	0.36

Council, National R. National Building Code 2015. National Research Council.

Province and Location	Elev., m	Design Temperature				De- gree- Days Below 18°C	15 Min. Rain, mm	One Day Rain, 1/50, mm	Ann. Rain, mm	Moist. Index	Ann. Tot. Ppn., mm	Driv- ing Rain Wind Pres- sures, Pa, 1/5	Snow Load, kPa, 1/50		Hourly Wind Pressures, kPa	
		January		July 2.5%									S _s	S _r	1/10	1/50
		2.5% °C	1% °C	Dry °C	Wet °C											
Stony Plain	710	-32	-35	28	19	5300	23	97	410	0.52	540	120	1.7	0.1	0.35	0.45
Suffield	755	-31	-34	32	20	4770	20	86	230	0.23	325	220	1.3	0.1	0.38	0.49
Taber	815	-31	-33	31	19	4580	20	92	260	0.26	370	200	1.2	0.1	0.48	0.63
Turner Valley	1215	-31	-32	28	17	5220	20	97	350	0.48	600	180	1.4	0.1	0.50	0.65
Valleyview	700	-37	-40	27	18	5600	18	86	360	0.54	490	80	2.3	0.1	0.33	0.42
Vegreville	635	-34	-37	29	19	5780	18	86	325	0.50	410	100	1.9	0.1	0.28	0.36
Vermilion	580	-35	-38	29	19	5740	18	86	310	0.53	410	100	1.7	0.1	0.28	0.36
Wagner	585	-35	-38	26	19	5850	15	81	380	0.62	500	80	1.9	0.1	0.29	0.37
Wainwright	675	-33	-36	29	19	5700	20	81	310	0.47	425	120	2.0	0.1	0.28	0.36
Wetaskiwin	760	-33	-35	29	19	5500	23	86	400	0.57	500	160	2.0	0.1	0.30	0.39
Whitecourt	690	-33	-36	27	19	5650	20	97	440	0.63	550	80	1.9	0.1	0.29	0.37
Wimborne	975	-31	-34	29	18	5310	23	92	325	0.48	450	200	1.6	0.1	0.31	0.40
Saskatchewan																
Assiniboia	740	-32	-34	31	21	5180	25	81	290	0.33	375	240	1.6	0.1	0.38	0.49
Batrum	700	-32	-34	32	20	5080	23	81	270	0.35	350	260	1.2	0.1	0.42	0.54
Biggar	645	-34	-36	30	20	5720	23	81	270	0.39	350	180	2.1	0.1	0.35	0.45
Broadview	600	-34	-35	30	21	5760	25	103	320	0.49	420	160	1.7	0.1	0.36	0.46
Dafoe	530	-35	-37	29	21	5860	20	92	300	0.46	380	140	1.7	0.1	0.29	0.37
Dundurn	525	-35	-37	30	21	5600	23	86	275	0.40	380	180	1.5	0.1	0.36	0.46
Estevan	565	-32	-34	32	22	5340	28	92	330	0.43	420	200	1.6	0.1	0.40	0.52
Hudson Bay	370	-36	-38	29	21	6280	20	81	340	0.59	450	80	2.0	0.1	0.29	0.37
Humboldt	565	-36	-38	28	21	6000	20	86	320	0.48	375	140	2.1	0.1	0.30	0.39
Island Falls	305	-39	-41	27	20	7100	18	76	370	0.62	510	80	2.1	0.1	0.27	0.35
Kamsack	455	-34	-37	29	22	6040	20	97	360	0.55	450	120	2.1	0.2	0.31	0.40
Kindersley	685	-33	-35	31	20	5550	23	81	260	0.38	325	200	1.4	0.1	0.36	0.46
Lloydminster	645	-34	-37	28	20	5880	18	81	310	0.53	430	120	2.0	0.1	0.31	0.40
Maple Creek	765	-31	-34	31	20	4780	25	81	275	0.28	380	220	1.2	0.1	0.35	0.45
Meadow Lake	480	-38	-40	28	20	6280	18	81	320	0.53	450	120	1.7	0.1	0.31	0.40
Melfort	455	-36	-38	28	21	6050	20	81	310	0.50	410	120	2.1	0.1	0.28	0.36
Melville	550	-34	-36	29	21	5880	23	97	340	0.52	410	160	1.7	0.1	0.31	0.40
Moose Jaw	545	-32	-34	31	21	5270	25	86	270	0.33	360	200	1.4	0.1	0.40	0.52
Nipawin	365	-37	-39	28	21	6300	20	76	340	0.56	450	100	2.0	0.1	0.29	0.38
North Battleford	545	-34	-36	29	20	5900	20	81	280	0.46	370	120	1.7	0.1	0.36	0.46
Prince Albert	435	-37	-40	28	21	6100	20	81	320	0.51	410	140	1.9	0.1	0.29	0.38
Qu'Appelle	645	-34	-36	30	22	5620	25	97	340	0.45	430	160	1.7	0.1	0.33	0.42
Regina	575	-34	-36	31	21	5600	28	103	300	0.39	365	200	1.4	0.1	0.38	0.49
Rosetown	595	-34	-36	31	20	5620	23	81	260	0.37	330	200	1.7	0.1	0.38	0.49
Saskatoon	500	-35	-37	30	21	5700	23	86	265	0.41	350	160	1.7	0.1	0.33	0.43
Scott	645	-34	-36	30	20	5960	20	81	270	0.41	360	140	1.9	0.1	0.35	0.45
Strasbourg	545	-34	-36	30	22	5600	25	92	300	0.41	390	180	1.5	0.1	0.33	0.42

Council, National R. National Building Code 2015. National Research Council.

Province and Location	Elev., m	Design Temperature				De- gree- Days Below 18°C	15 Min. Rain, mm	One Day Rain, 1/50, mm	Ann. Rain, mm	Moist. Index	Ann. Tot. Ppn., mm	Driv- ing Rain Wind Pres- sures, Pa, 1/5	Snow Load, kPa, 1/50		Hourly Wind Pressures, kPa	
		January		July 2.5%									S _s	S _r	1/10	1/50
		2.5% °C	1% °C	Dry °C	Wet °C											
Swift Current	750	-31	-34	31	20	5150	25	81	260	0.34	350	240	1.4	0.1	0.42	0.54
Uranium City	265	-42	-44	26	19	7500	12	54	300	0.59	360	100	2.0	0.1	0.28	0.36
Weyburn	575	-33	-35	31	23	5400	28	97	320	0.40	400	200	1.8	0.1	0.37	0.48
Yorkton	510	-34	-37	29	21	6000	23	97	350	0.54	440	140	1.9	0.1	0.31	0.40
Manitoba																
Beausejour	245	-33	-35	29	23	5680	28	103	430	0.61	530	180	2.0	0.2	0.32	0.41
Boissevain	510	-32	-34	30	23	5500	28	119	390	0.54	510	180	2.2	0.2	0.40	0.52
Brandon	395	-33	-35	30	22	5760	28	108	375	0.56	460	180	2.1	0.2	0.38	0.49
Churchill	10	-38	-40	25	18	8950	12	76	265	0.82	410	260	3.0	0.2	0.43	0.55
Dauphin	295	-33	-35	30	22	5900	28	103	400	0.56	490	160	1.9	0.2	0.31	0.40
Flin Flon	300	-38	-40	27	20	6440	18	81	340	0.59	475	80	2.2	0.2	0.27	0.35
Gimli	220	-34	-36	29	23	5800	28	108	410	0.65	530	180	1.9	0.2	0.31	0.40
Island Lake	240	-36	-38	27	20	6900	18	86	380	0.67	550	80	2.6	0.2	0.29	0.37
Lac du Bonnet	260	-34	-36	29	23	5730	28	103	445	0.65	560	180	1.9	0.2	0.29	0.37
Lynn Lake	350	-40	-42	27	19	7770	18	86	310	0.62	490	100	2.4	0.2	0.29	0.37
Morden	300	-31	-33	30	24	5400	28	119	420	0.55	520	180	2.2	0.2	0.40	0.52
Neepawa	365	-32	-34	29	23	5760	28	108	410	0.58	470	180	2.2	0.2	0.34	0.44
Pine Falls	220	-34	-36	28	23	5900	25	97	440	0.66	420	180	1.9	0.2	0.30	0.39
Portage la Prairie	260	-31	-33	30	23	5600	28	108	390	0.51	525	180	2.1	0.2	0.36	0.46
Rivers	465	-34	-36	29	23	5840	28	108	370	0.56	460	180	2.1	0.2	0.36	0.46
Sandilands	365	-32	-34	29	23	5650	28	113	460	0.58	550	180	2.2	0.2	0.31	0.40
Selkirk	225	-33	-35	29	23	5700	28	108	420	0.61	500	180	1.9	0.2	0.32	0.41
Split Lake	175	-38	-40	27	19	7900	18	76	325	0.66	500	120	2.5	0.2	0.30	0.39
Steinbach	270	-33	-35	29	23	5700	28	108	440	0.58	500	180	2.0	0.2	0.31	0.40
Swan River	335	-34	-37	29	22	6100	20	92	370	0.58	500	120	2.0	0.2	0.27	0.35
The Pas	270	-36	-38	28	21	6480	18	81	330	0.59	450	160	2.2	0.2	0.29	0.37
Thompson	205	-40	-43	27	19	7600	18	86	350	0.64	540	100	2.4	0.2	0.28	0.36
Virden	435	-33	-35	30	23	5620	28	108	350	0.53	460	180	2.0	0.2	0.36	0.46
Winnipeg	235	-33	-35	30	23	5670	28	108	415	0.58	500	180	1.9	0.2	0.35	0.45
Ontario																
Ailsa Craig	230	-17	-19	30	23	3840	25	103	800	0.93	950	180	2.2	0.4	0.39	0.50
Ajax	95	-20	-22	30	23	3820	23	92	760	0.90	825	160	1.0	0.4	0.37	0.48
Alexandria	80	-24	-26	30	23	4600	25	103	800	0.91	975	160	2.4	0.4	0.31	0.40
Alliston	220	-23	-25	29	23	4200	28	113	690	0.81	875	120	2.0	0.4	0.28	0.36
Almonte	120	-26	-28	30	23	4620	25	97	730	0.84	800	140	2.5	0.4	0.32	0.41
Armstrong	340	-37	-40	28	21	6500	23	97	525	0.75	725	100	2.7	0.4	0.23	0.30
Arnprior	85	-27	-29	30	23	4680	23	86	630	0.76	775	140	2.5	0.4	0.29	0.37
Atikokan	400	-33	-35	29	22	5750	25	103	570	0.77	760	100	2.4	0.3	0.23	0.30
Attawapiskat	10	-37	-39	28	21	7100	18	81	450	0.79	650	160	2.8	0.3	0.32	0.41
Aurora	270	-21	-23	30	23	4210	28	108	700	0.81	800	140	2.0	0.4	0.34	0.44

Council, National R. National Building Code 2015. National Research Council.

Province and Location	Elev., m	Design Temperature				De- gree- Days Below 18°C	15 Min. Rain, mm	One Day Rain, 1/50, mm	Ann. Rain, mm	Moist. Index	Ann. Tot. Ppn., mm	Driv- ing Rain Wind Pres- sures, Pa, 1/5	Snow Load, kPa, 1/50		Hourly Wind Pressures, kPa	
		January		July 2.5%									S _s	S _r	1/10	1/50
		2.5% °C	1% °C	Dry °C	Wet °C											
Bancroft	365	-28	-31	29	23	4740	25	92	720	0.85	900	100	3.1	0.4	0.25	0.32
Barrie	245	-24	-26	29	23	4380	28	97	700	0.83	900	120	2.5	0.4	0.28	0.36
Barriefield	100	-22	-24	28	23	3990	23	108	780	0.96	950	160	2.1	0.4	0.36	0.47
Beaverton	240	-24	-26	30	23	4300	25	108	720	0.87	950	120	2.2	0.4	0.28	0.36
Belleville	90	-22	-24	29	23	3910	23	97	760	0.89	850	180	1.7	0.4	0.33	0.43
Belmont	260	-17	-19	30	24	3840	25	97	850	0.95	950	180	1.7	0.4	0.36	0.47
Kitchenuhmay- koosib (Big Trout Lake)	215	-38	-40	26	20	7450	18	92	400	0.75	600	150	3.2	0.2	0.33	0.42
CFB Borden	225	-23	-25	29	23	4300	28	103	690	0.82	875	120	2.2	0.4	0.28	0.36
Bracebridge	310	-26	-28	29	23	4800	25	103	830	0.95	1050	120	3.1	0.4	0.27	0.35
Bradford	240	-23	-25	30	23	4280	28	108	680	0.80	800	120	2.1	0.4	0.28	0.36
Brampton	215	-19	-21	30	23	4100	28	119	720	0.81	820	140	1.3	0.4	0.34	0.44
Brantford	205	-18	-20	30	23	3900	23	103	780	0.89	850	160	1.3	0.4	0.33	0.42
Brighton	95	-21	-23	29	23	4000	23	94	760	0.90	850	160	1.6	0.4	0.37	0.48
Brockville	85	-23	-25	29	23	4060	25	103	770	0.89	975	180	2.2	0.4	0.34	0.44
Burk's Falls	305	-26	-28	29	22	5020	25	97	810	0.94	1010	120	2.7	0.4	0.27	0.35
Burlington	80	-17	-19	31	23	3740	23	103	770	0.91	850	160	1.1	0.4	0.36	0.46
Cambridge	295	-18	-20	29	23	4100	25	113	800	0.91	890	160	1.6	0.4	0.28	0.36
Campbellford	150	-23	-26	30	23	4280	25	97	730	0.85	850	160	1.7	0.4	0.32	0.41
Cannington	255	-24	-26	30	23	4310	25	108	740	0.85	950	120	2.2	0.4	0.28	0.36
Carleton Place	135	-25	-27	30	23	4600	25	97	730	0.84	850	160	2.5	0.4	0.32	0.41
Cavan	200	-23	-25	30	23	4400	25	97	740	0.86	850	140	2.0	0.4	0.34	0.44
Centralia	260	-17	-19	30	23	3800	25	103	820	0.95	1000	180	2.3	0.4	0.38	0.49
Chapleau	425	-35	-38	27	21	5900	20	97	530	0.72	850	80	3.6	0.4	0.23	0.30
Chatham	180	-16	-18	31	24	3470	28	103	800	0.86	850	180	1.0	0.4	0.33	0.43
Chesley	275	-19	-21	29	22	4320	28	103	810	0.94	1125	140	2.8	0.4	0.37	0.48
Clinton	280	-17	-19	29	23	4150	25	103	810	0.94	1000	160	2.6	0.4	0.38	0.49
Coboconk	270	-25	-27	30	23	4500	25	108	740	0.87	950	120	2.5	0.4	0.27	0.35
Cobourg	90	-21	-23	29	23	3980	23	94	760	0.90	825	160	1.2	0.4	0.38	0.49
Cochrane	245	-34	-36	29	21	6200	20	92	575	0.77	875	80	2.8	0.3	0.27	0.35
Colborne	105	-21	-23	29	23	3980	23	94	760	0.90	850	160	1.6	0.4	0.38	0.49
Collingwood	190	-21	-23	29	23	4180	28	97	720	0.87	950	160	2.7	0.4	0.30	0.39
Cornwall	35	-23	-25	30	23	4250	25	103	780	0.89	960	180	2.2	0.4	0.32	0.41
Corunna	185	-16	-18	31	24	3600	25	100	760	0.87	800	180	1.0	0.4	0.36	0.47
Deep River	145	-29	-32	30	22	4900	23	92	650	0.82	850	100	2.5	0.4	0.27	0.35
Deseronto	85	-22	-24	29	23	4070	23	92	760	0.89	900	160	1.9	0.4	0.33	0.43
Dorchester	260	-18	-20	30	24	3900	28	103	850	0.96	950	180	1.9	0.4	0.36	0.47
Dorion	200	-33	-35	28	21	5950	20	103	550	0.77	725	160	2.8	0.4	0.30	0.39
Dresden	185	-16	-18	31	24	3750	28	97	760	0.84	820	180	1.0	0.4	0.33	0.43
Dryden	370	-34	-36	28	22	5850	25	97	550	0.70	700	120	2.4	0.3	0.23	0.30

Council, National R. National Building Code 2015. National Research Council.

Province and Location	Elev., m	Design Temperature				De- gree- Days Below 18°C	15 Min. Rain, mm	One Day Rain, 1/50, mm	Ann. Rain, mm	Moist. Index	Ann. Tot. Ppn., mm	Driv- ing Rain Wind Pres- sures, Pa, 1/5	Snow Load, kPa, 1/50		Hourly Wind Pressures, kPa	
		January		July 2.5%									S _s	S _r	1/10	1/50
		2.5% °C	1% °C	Dry °C	Wet °C											
Dundalk	525	-22	-24	29	22	4700	28	108	750	0.89	1080	150	3.2	0.4	0.33	0.42
Dunnville	175	-15	-17	30	24	3660	23	108	830	0.95	950	160	2.0	0.4	0.36	0.46
Durham	340	-20	-22	29	22	4340	28	103	815	0.94	1025	140	2.8	0.4	0.34	0.44
Dutton	225	-16	-18	31	24	3700	28	92	850	0.96	925	180	1.3	0.4	0.36	0.47
Earlton	245	-33	-36	29	22	5730	23	92	560	0.75	820	120	3.1	0.4	0.35	0.45
Edison	365	-34	-36	28	22	5740	25	108	510	0.65	680	120	2.4	0.3	0.24	0.31
Elliot Lake	380	-26	-28	29	21	4950	23	108	630	0.83	950	160	2.9	0.4	0.29	0.38
Elmvale	220	-24	-26	29	23	4200	28	97	720	0.87	950	140	2.6	0.4	0.28	0.36
Embros	310	-19	-21	30	23	3950	28	113	830	0.94	950	160	2.0	0.4	0.37	0.48
Englehart	205	-33	-36	29	22	5800	23	92	600	0.78	880	100	2.8	0.4	0.32	0.41
Espanola	220	-25	-27	29	21	4920	23	108	650	0.83	840	160	2.3	0.4	0.33	0.42
Exeter	265	-17	-19	30	23	3900	25	113	810	0.94	975	180	2.4	0.4	0.38	0.49
Fenelon Falls	260	-25	-27	30	23	4440	25	108	730	0.86	950	120	2.3	0.4	0.28	0.36
Fergus	400	-20	-22	29	23	4300	28	108	760	0.87	925	160	2.2	0.4	0.28	0.36
Forest	215	-16	-18	31	23	3740	25	103	810	0.95	875	160	2.0	0.4	0.37	0.48
Fort Erie	180	-15	-17	30	24	3650	23	108	860	0.98	1020	160	2.3	0.4	0.36	0.46
Fort Erie (Ridgeway)	190	-15	-17	30	24	3600	25	108	860	0.98	1000	160	2.3	0.4	0.36	0.46
Fort Frances	340	-33	-35	29	22	5440	25	108	570	0.71	725	120	2.3	0.3	0.24	0.31
Gananoque	80	-22	-24	28	23	4010	23	103	760	0.91	900	180	2.1	0.4	0.36	0.47
Geraldton	345	-36	-39	28	21	6450	20	86	550	0.77	725	100	2.9	0.4	0.23	0.30
Glencoe	215	-16	-18	31	24	3680	28	103	800	0.91	925	180	1.5	0.4	0.33	0.43
Goderich	185	-16	-18	29	23	4000	25	92	810	0.95	950	180	2.4	0.4	0.43	0.55
Gore Bay	205	-24	-26	28	22	4700	23	92	640	0.84	860	160	2.6	0.4	0.34	0.44
Graham	495	-35	-37	29	22	5940	23	97	570	0.75	750	140	2.6	0.3	0.23	0.30
Gravenhurst (Muskoka Airport)	255	-26	-28	29	23	4760	25	103	790	0.92	1050	120	2.7	0.4	0.28	0.36
Grimsby	85	-16	-18	30	23	3520	23	108	760	0.90	875	160	0.9	0.4	0.36	0.46
Guelph	340	-19	-21	29	23	4270	28	103	770	0.88	875	140	1.9	0.4	0.28	0.36
Guthrie	280	-24	-26	29	23	4300	28	103	700	0.83	950	120	2.5	0.4	0.28	0.36
Haileybury	210	-32	-35	30	22	5600	23	92	590	0.77	820	120	2.4	0.4	0.34	0.44
Haldimand (Caledonia)	190	-18	-20	30	23	3750	23	108	810	0.93	875	160	1.2	0.4	0.34	0.44
Haldimand (Hagersville)	215	-17	-19	30	23	3760	25	97	840	0.95	875	160	1.3	0.4	0.36	0.46
Haliburton	335	-27	-29	29	23	4840	25	92	780	0.90	980	100	2.9	0.4	0.27	0.35
Halton Hills (Georgetown)	255	-19	-21	30	23	4200	28	119	750	0.84	850	140	1.4	0.4	0.29	0.37
Hamilton	90	-17	-19	31	23	3460	23	108	810	0.90	875	160	1.1	0.4	0.36	0.46
Hanover	270	-19	-21	29	22	4300	28	103	790	0.92	1050	140	2.6	0.4	0.37	0.48
Hastings	200	-24	-26	30	23	4280	25	92	730	0.85	840	140	2.0	0.4	0.32	0.41
Hawkesbury	50	-25	-27	30	23	4610	23	103	800	0.91	925	160	2.3	0.4	0.32	0.41
Hearst	245	-35	-37	29	21	6450	20	86	520	0.74	825	80	2.8	0.3	0.23	0.30

Council, National R. National Building Code 2015. National Research Council.

Province and Location	Elev., m	Design Temperature				De- gree- Days Below 18°C	15 Min. Rain, mm	One Day Rain, 1/50, mm	Ann. Rain, mm	Moist. Index	Ann. Tot. Ppn., mm	Driv- ing Rain Wind Pres- sures, Pa, 1/5	Snow Load, kPa, 1/50		Hourly Wind Pressures, kPa	
		January		July 2.5%									S _s	S _r	1/10	1/50
		2.5% °C	1% °C	Dry °C	Wet °C											
Honey Harbour	180	-24	-26	29	23	4300	25	97	710	0.87	1050	160	2.7	0.4	0.30	0.39
Hornepayne	360	-37	-40	28	21	6340	20	93	420	0.68	750	80	3.3	0.4	0.23	0.30
Huntsville	335	-26	-29	29	22	4850	25	103	800	0.93	1000	120	2.9	0.4	0.27	0.35
Ingersoll	280	-18	-20	30	23	3920	28	108	840	0.95	950	180	1.7	0.4	0.37	0.48
Iroquois Falls	275	-33	-36	29	21	6100	20	86	575	0.77	825	100	2.9	0.3	0.29	0.37
Jellicoe	330	-36	-39	28	21	6400	20	86	550	0.76	750	100	2.7	0.4	0.23	0.30
Kapuskasing	245	-34	-36	29	21	6250	20	86	550	0.76	825	100	3.0	0.3	0.24	0.31
Kemptville	90	-25	-27	30	23	4540	25	92	750	0.86	925	160	2.3	0.4	0.32	0.41
Kenora	370	-33	-35	28	22	5630	25	113	515	0.64	630	120	2.5	0.3	0.24	0.31
Killaloe	185	-28	-31	30	22	4960	23	86	680	0.83	825	120	2.7	0.4	0.27	0.35
Kincardine	190	-17	-19	28	22	3890	25	92	800	0.95	950	180	2.6	0.4	0.43	0.55
Kingston	80	-22	-24	28	23	4000	23	108	780	0.96	950	180	2.1	0.4	0.36	0.47
Kinmount	295	-26	-28	29	23	4600	25	108	750	0.88	950	120	2.7	0.4	0.27	0.35
Kirkland Lake	325	-33	-36	29	22	6000	23	92	600	0.78	875	100	2.9	0.3	0.30	0.39
Kitchener	335	-19	-21	29	23	4200	28	119	780	0.89	925	140	2.0	0.4	0.29	0.37
Lakefield	240	-24	-26	30	23	4330	25	92	720	0.85	850	140	2.2	0.4	0.29	0.38
Lansdowne House	240	-38	-40	28	21	7150	23	92	500	0.78	680	140	3.0	0.2	0.25	0.32
Leamington	190	-15	-17	31	24	3400	28	113	800	0.91	875	180	0.8	0.4	0.36	0.47
Lindsay	265	-24	-26	30	23	4320	25	103	720	0.84	850	140	2.3	0.4	0.29	0.38
Lion's Head	185	-19	-21	27	22	4300	25	103	700	0.89	950	180	2.7	0.4	0.37	0.48
Listowel	380	-19	-21	29	23	4300	28	119	800	0.93	1000	160	2.6	0.4	0.36	0.47
London	245	-18	-20	30	24	3900	28	103	825	0.94	975	180	1.9	0.4	0.36	0.47
Lucan	300	-17	-19	30	23	3900	25	113	810	0.94	1000	180	2.3	0.4	0.39	0.50
Maitland	85	-23	-25	29	23	4080	25	103	770	0.89	975	180	2.2	0.4	0.34	0.44
Markdale	425	-20	-22	29	22	4500	28	103	820	0.94	1050	160	3.2	0.4	0.32	0.41
Markham	175	-21	-23	31	24	4000	25	86	720	0.81	825	140	1.3	0.4	0.34	0.44
Martin	485	-35	-37	29	22	5900	25	103	560	0.75	750	120	2.6	0.3	0.23	0.30
Matheson	265	-33	-36	29	21	6080	20	86	580	0.77	825	100	2.8	0.3	0.30	0.39
Mattawa	165	-29	-31	30	22	5050	23	86	700	0.86	875	100	2.1	0.4	0.25	0.32
Midland	190	-24	-26	29	23	4200	25	97	740	0.88	1060	160	2.7	0.4	0.30	0.39
Milton	200	-18	-20	30	23	3920	25	125	750	0.85	850	160	1.3	0.4	0.33	0.43
Milverton	370	-19	-21	29	23	4200	28	108	800	0.93	1050	160	2.4	0.4	0.33	0.43
Minden	270	-27	-29	29	23	4640	25	97	780	0.90	1010	100	2.7	0.4	0.27	0.35
Mississauga	160	-18	-20	30	23	3880	25	113	720	0.85	800	160	1.1	0.4	0.34	0.44
Mississauga (Lester B. Pearson Int'l Airport)	170	-20	-22	31	24	3890	26	108	685	0.81	790	160	1.1	0.4	0.34	0.44
Mississauga (Port Credit)	75	-18	-20	29	23	3780	25	108	720	0.87	800	160	0.9	0.4	0.37	0.48
Mitchell	335	-18	-20	29	23	4100	28	113	810	0.94	1050	160	2.4	0.4	0.37	0.48
Moosonee	10	-36	-38	28	22	6800	18	81	500	0.84	700	160	2.7	0.3	0.27	0.35
Morrisburg	75	-23	-25	30	23	4370	25	103	800	0.91	950	180	2.3	0.4	0.32	0.41

Council, National R. National Building Code 2015. National Research Council.

Province and Location	Elev., m	Design Temperature				De- gree- Days Below 18°C	15 Min. Rain, mm	One Day Rain, 1/50, mm	Ann. Rain, mm	Moist. Index	Ann. Tot. Ppn., mm	Driv- ing Rain Wind Pres- sures, Pa, 1/5	Snow Load, kPa, 1/50		Hourly Wind Pressures, kPa	
		January		July 2.5%									S _s	S _r	1/10	1/50
		2.5% °C	1% °C	Dry °C	Wet °C											
Mount Forest	420	-21	-24	28	22	4700	28	103	740	0.87	940	140	2.7	0.4	0.32	0.41
Nakina	325	-36	-38	28	21	6500	20	86	540	0.76	750	100	2.8	0.4	0.23	0.30
Nanticoke (Jarvis)	205	-17	-18	30	23	3700	28	108	840	0.95	900	160	1.4	0.4	0.37	0.48
Nanticoke (Port Dover)	180	-15	-17	30	24	3600	25	108	860	0.98	950	140	1.2	0.4	0.37	0.48
Napanee	90	-22	-24	29	23	4140	23	92	770	0.90	900	160	1.9	0.4	0.33	0.43
New Liskeard	180	-32	-35	30	22	5570	23	92	570	0.75	810	100	2.6	0.4	0.33	0.43
Newcastle	115	-20	-22	30	23	3990	23	86	760	0.90	830	160	1.5	0.4	0.37	0.48
Newcastle (Bowmanville)	95	-20	-22	30	23	4000	23	86	760	0.90	830	160	1.4	0.4	0.37	0.48
Newmarket	185	-22	-24	30	23	4260	28	108	700	0.81	800	140	2.0	0.4	0.29	0.38
Niagara Falls	210	-16	-18	30	23	3600	23	96	810	0.94	950	160	1.8	0.4	0.33	0.43
North Bay	210	-28	-30	28	22	5150	25	95	775	0.93	975	120	2.2	0.4	0.27	0.34
Norwood	225	-24	-26	30	23	4320	25	92	720	0.84	850	120	2.1	0.4	0.32	0.41
Oakville	90	-18	-20	30	23	3760	23	97	750	0.90	850	160	1.1	0.4	0.36	0.47
Orangeville	430	-21	-23	29	23	4450	28	108	730	0.84	875	140	2.3	0.4	0.28	0.36
Orillia	230	-25	-27	29	23	4260	25	103	740	0.88	1000	120	2.4	0.4	0.28	0.36
Oshawa	110	-19	-21	30	23	3860	23	86	760	0.90	875	160	1.4	0.4	0.37	0.48
Ottawa (Metropolitan)																
Ottawa (City Hall)	70	-25	-27	30	23	4440	23	86	750	0.84	900	160	2.4	0.4	0.32	0.41
Ottawa (Barrhaven)	98	-25	-27	30	23	4500	25	92	750	0.84	900	160	2.4	0.4	0.32	0.41
Ottawa (Kanata)	98	-25	-27	30	23	4520	25	92	730	0.84	900	160	2.5	0.4	0.32	0.41
Ottawa (M-C Int'l Airport)	125	-25	-27	30	23	4500	24	89	750	0.84	900	160	2.4	0.4	0.32	0.41
Ottawa (Orleans)	70	-26	-28	30	23	4500	23	91	750	0.84	900	160	2.4	0.4	0.32	0.41
Owen Sound	215	-19	-21	29	22	4030	28	113	760	0.90	1075	160	2.8	0.4	0.37	0.48
Pagwa River	185	-35	-37	28	21	6500	20	86	540	0.76	825	80	2.7	0.4	0.23	0.30
Paris	245	-18	-20	30	23	4000	23	96	790	0.90	925	160	1.4	0.4	0.33	0.42
Parkhill	205	-16	-18	31	23	3800	25	103	800	0.93	925	180	2.1	0.4	0.39	0.50
Parry Sound	215	-24	-26	28	22	4640	23	97	820	0.95	1050	160	2.8	0.4	0.30	0.39
Pelham (Fonthill)	230	-15	-17	30	23	3690	23	96	820	0.94	950	160	2.1	0.4	0.33	0.42
Pembroke	125	-28	-31	30	23	4980	23	105	640	0.80	825	100	2.5	0.4	0.27	0.35
Penetanguishene	220	-24	-26	29	23	4200	25	97	720	0.87	1050	160	2.8	0.4	0.30	0.39
Perth	130	-25	-27	30	23	4540	25	92	730	0.84	900	140	2.3	0.4	0.32	0.41
Petawawa	135	-29	-31	30	23	4980	23	92	640	0.80	825	100	2.6	0.4	0.27	0.35
Peterborough	200	-23	-25	30	23	4400	25	92	710	0.83	840	140	2.0	0.4	0.32	0.41
Petrolia	195	-16	-18	31	24	3640	25	108	810	0.89	920	180	1.3	0.4	0.36	0.47
Pickering (Dunbarton)	85	-19	-21	30	23	3800	23	92	730	0.88	825	140	1.0	0.4	0.37	0.48
Picton	95	-21	-23	29	23	3980	23	92	770	0.91	940	160	2.0	0.4	0.38	0.49
Plattsville	300	-19	-21	29	23	4150	28	103	820	0.93	950	140	1.9	0.4	0.33	0.42
Point Alexander	150	-29	-32	30	22	4960	23	92	650	0.82	850	100	2.5	0.4	0.27	0.35
Port Burwell	195	-15	-17	30	24	3800	25	92	930	1.05	1000	180	1.2	0.4	0.36	0.47

Council, National R. National Building Code 2015. National Research Council.

Province and Location	Elev., m	Design Temperature				De- gree- Days Below 18°C	15 Min. Rain, mm	One Day Rain, 1/50, mm	Ann. Rain, mm	Moist. Index	Ann. Tot. Ppn., mm	Driv- ing Rain Wind Pres- sures, Pa, 1/5	Snow Load, kPa, 1/50		Hourly Wind Pressures, kPa	
		January		July 2.5%									S _s	S _r	1/10	1/50
		2.5% °C	1% °C	Dry °C	Wet °C											
Port Colborne	180	-15	-17	30	24	3600	23	108	850	0.97	1000	160	2.1	0.4	0.36	0.46
Port Elgin	205	-17	-19	28	22	4100	25	92	790	0.94	850	180	2.8	0.4	0.43	0.55
Port Hope	100	-21	-23	29	23	3970	23	94	760	0.90	825	180	1.2	0.4	0.37	0.48
Port Perry	270	-22	-24	30	23	4260	25	97	720	0.84	850	140	2.4	0.4	0.34	0.44
Port Stanley	180	-15	-17	31	24	3850	25	92	940	1.05	975	180	1.2	0.4	0.36	0.47
Prescott	90	-23	-25	29	23	4120	25	103	770	0.88	975	180	2.2	0.4	0.34	0.44
Princeton	280	-18	-20	30	23	4000	25	97	810	0.92	925	160	1.5	0.4	0.33	0.42
Raith	475	-34	-37	28	22	5900	23	97	570	0.75	750	120	2.7	0.4	0.23	0.30
Rayside-Balfour (Chelmsford)	270	-28	-30	29	21	5200	25	92	650	0.80	850	180	2.5	0.4	0.35	0.45
Red Lake	360	-35	-37	28	21	6220	20	92	470	0.69	630	120	2.6	0.3	0.23	0.30
Renfrew	115	-27	-30	30	23	4900	23	97	620	0.75	810	140	2.5	0.4	0.27	0.35
Richmond Hill	230	-21	-23	31	24	4000	25	97	740	0.83	850	140	1.5	0.4	0.34	0.44
Rockland	50	-26	-28	30	23	4600	23	92	780	0.89	950	160	2.4	0.4	0.31	0.40
Sarnia	190	-16	-18	31	24	3750	25	100	750	0.87	825	180	1.1	0.4	0.36	0.47
Sault Ste. Marie	190	-25	-28	29	22	4960	23	97	660	0.89	950	200	3.1	0.4	0.34	0.44
Schreiber	310	-34	-36	27	21	5960	20	103	600	0.82	850	160	3.3	0.4	0.30	0.39
Seaforth	310	-17	-19	30	23	4100	25	108	810	0.94	1025	160	2.5	0.4	0.37	0.48
Shelburne	495	-22	-24	29	23	4700	28	108	740	0.88	900	150	3.1	0.4	0.31	0.40
Simcoe	210	-17	-19	30	24	3700	28	113	860	0.97	950	160	1.3	0.4	0.35	0.45
Sioux Lookout	375	-34	-36	28	22	5950	25	97	520	0.69	710	100	2.6	0.3	0.23	0.30
Smiths Falls	130	-25	-27	30	23	4540	25	92	730	0.84	850	140	2.3	0.4	0.32	0.41
Smithville	185	-16	-18	30	23	3650	23	108	800	0.92	900	160	1.5	0.4	0.33	0.42
Smooth Rock Falls	235	-34	-36	29	21	6250	20	92	560	0.77	850	80	2.7	0.3	0.25	0.32
South River	355	-27	-29	29	22	5090	25	103	830	0.96	975	120	2.8	0.4	0.27	0.35
Southampton	180	-17	-19	28	22	4100	25	92	800	0.95	830	180	2.7	0.4	0.41	0.53
St. Catharines	105	-16	-18	30	23	3540	23	92	770	0.90	850	160	1.0	0.4	0.36	0.46
St. Mary's	310	-18	-20	30	23	4000	28	108	820	0.95	1025	160	2.2	0.4	0.36	0.47
St. Thomas	225	-16	-18	31	24	3780	25	103	900	0.99	975	180	1.4	0.4	0.36	0.47
Stirling	120	-23	-25	30	23	4220	25	97	740	0.86	850	120	1.7	0.4	0.31	0.40
Stratford	360	-18	-20	29	23	4050	28	113	820	0.95	1050	160	2.3	0.4	0.35	0.45
Strathroy	225	-17	-19	31	24	3780	25	103	770	0.88	950	180	1.9	0.4	0.36	0.47
Sturgeon Falls	205	-28	-30	29	21	5200	25	95	700	0.86	910	140	2.4	0.4	0.27	0.35
Sudbury	275	-28	-30	29	21	5180	25	97	650	0.79	875	200	2.5	0.4	0.36	0.46
Sundridge	340	-27	-29	29	22	5080	25	97	840	0.97	975	120	2.8	0.4	0.27	0.35
Tavistock	340	-19	-21	29	23	4100	28	113	820	0.95	1010	160	2.1	0.4	0.35	0.45
Temagami	300	-30	-33	30	22	5420	23	92	650	0.82	875	120	2.6	0.4	0.29	0.37
Thamesford	280	-19	-21	30	23	3950	28	108	820	0.93	975	160	1.9	0.4	0.37	0.48
Theford	205	-16	-18	31	23	3710	25	103	810	0.95	900	180	2.1	0.4	0.39	0.50
Thunder Bay	210	-31	-33	29	21	5650	23	108	560	0.76	710	160	2.9	0.4	0.30	0.39

Council, National R. National Building Code 2015. National Research Council.

Province and Location	Elev., m	Design Temperature				De- gree- Days Below 18°C	15 Min. Rain, mm	One Day Rain, 1/50, mm	Ann. Rain, mm	Moist. Index	Ann. Tot. Ppn., mm	Driv- ing Rain Wind Pres- sures, Pa, 1/5	Snow Load, kPa, 1/50		Hourly Wind Pressures, kPa	
		January		July 2.5%									S _s	S _r	1/10	1/50
		2.5% °C	1% °C	Dry °C	Wet °C											
Tillsonburg	215	-17	-19	30	24	3840	25	103	880	0.98	980	160	1.3	0.4	0.34	0.44
Timmins	300	-34	-36	29	21	5940	20	108	560	0.75	875	100	3.1	0.3	0.27	0.35
Timmins (Porcupine)	295	-34	-36	29	21	6000	20	103	560	0.75	875	100	2.9	0.3	0.29	0.37
Toronto Metropolitan Region																
Etobicoke	160	-20	-22	31	24	3800	26	108	720	0.80	800	160	1.1	0.4	0.34	0.44
North York	175	-20	-22	31	24	3760	25	108	730	0.82	850	150	1.2	0.4	0.34	0.44
Scarborough	180	-20	-22	31	24	3800	25	92	730	0.87	825	160	1.2	0.4	0.36	0.47
Toronto (City Hall)	90	-18	-20	31	23	3520	25	97	720	0.86	820	160	0.9	0.4	0.34	0.44
Trenton	80	-22	-24	29	23	4110	23	97	760	0.89	850	160	1.6	0.4	0.36	0.47
Trout Creek	330	-27	-29	29	22	5100	25	103	780	0.92	975	120	2.7	0.4	0.27	0.35
Uxbridge	275	-22	-24	30	23	4240	25	103	700	0.82	850	140	2.4	0.4	0.33	0.42
Vaughan (Woodbridge)	165	-20	-22	31	24	4100	26	113	700	0.80	800	140	1.1	0.4	0.34	0.44
Vittoria	215	-15	-17	30	24	3680	25	113	880	0.99	950	160	1.3	0.4	0.36	0.47
Walkerton	275	-18	-20	30	22	4300	28	103	790	0.92	1025	160	2.7	0.4	0.39	0.50
Wallaceburg	180	-16	-18	31	24	3600	28	97	760	0.87	825	180	0.9	0.4	0.35	0.45
Waterloo	330	-19	-21	29	23	4200	28	119	780	0.89	925	160	2.0	0.4	0.29	0.37
Watford	240	-17	-19	31	24	3740	25	108	790	0.90	950	160	1.9	0.4	0.36	0.47
Wawa	290	-34	-36	26	21	5840	20	93	725	0.93	950	160	3.4	0.4	0.30	0.39
Welland	180	-15	-17	30	23	3670	23	103	840	0.96	975	160	2.0	0.4	0.33	0.43
West Lorne	215	-16	-18	31	24	3700	28	103	840	0.95	900	180	1.3	0.4	0.36	0.47
Whitby	85	-20	-22	30	23	3820	23	86	760	0.90	850	160	1.2	0.4	0.37	0.48
Whitby (Brooklin)	160	-20	-22	30	23	4010	23	86	770	0.91	850	140	1.9	0.4	0.35	0.45
White River	375	-39	-42	28	21	6150	20	92	575	0.80	825	100	3.6	0.4	0.23	0.30
Warton	185	-19	-21	29	22	4300	25	103	740	0.91	1000	180	2.7	0.4	0.37	0.48
Windsor	185	-16	-18	32	24	3400	28	103	800	0.85	900	180	0.8	0.4	0.36	0.47
Wingham	310	-18	-20	30	23	4220	28	108	780	0.91	1050	160	2.6	0.4	0.39	0.50
Woodstock	300	-19	-21	30	23	3910	28	113	830	0.94	930	160	1.9	0.4	0.34	0.44
Wyoming	215	-16	-18	31	24	3700	25	103	815	0.92	900	180	1.6	0.4	0.36	0.47
Quebec																
Acton-Vale	95	-24	-27	30	23	4620	21	107	860	0.97	1050	180	2.3	0.4	0.27	0.35
Alma	110	-31	-33	28	22	5800	20	91	700	0.86	950	160	3.3	0.4	0.27	0.35
Amos	295	-34	-36	28	21	6160	20	91	670	0.85	920	100	3.2	0.3	0.25	0.32
Asbestos	245	-26	-28	29	22	4800	23	96	870	0.98	1050	160	2.8	0.6	0.27	0.35
Aylmer	90	-25	-28	30	23	4520	23	91	730	0.84	900	160	2.5	0.4	0.32	0.41
Baie-Comeau	60	-27	-29	25	19	6020	16	91	680	0.96	1000	220	4.3	0.4	0.39	0.50
Baie-Saint-Paul	20	-27	-29	28	21	5280	18	102	730	0.89	1000	180	3.4	0.6	0.37	0.48
Beauport	45	-26	-29	28	22	5100	20	107	980	1.09	1200	200	3.4	0.6	0.33	0.42
Bedford	55	-24	-26	29	23	4420	23	91	880	0.99	1260	160	2.1	0.4	0.32	0.41
Beloeil	25	-24	-26	30	23	4500	23	91	840	0.95	1025	180	2.4	0.4	0.29	0.37

Council, National R. National Building Code 2015. National Research Council.

Province and Location	Elev., m	Design Temperature				De- gree- Days Below 18°C	15 Min. Rain, mm	One Day Rain, 1/50, mm	Ann. Rain, mm	Moist. Index	Ann. Tot. Ppn., mm	Driv- ing Rain Wind Pres- sures, Pa, 1/5	Snow Load, kPa, 1/50		Hourly Wind Pressures, kPa	
		January		July 2.5%									S _s	S _r	1/10	1/50
		2.5% °C	1% °C	Dry °C	Wet °C											
Brome	210	-25	-27	29	23	4730	23	96	990	1.09	1240	160	2.5	0.4	0.29	0.37
Brossard	15	-24	-26	30	23	4420	23	91	800	0.90	1025	180	2.4	0.4	0.33	0.42
Buckingham	130	-26	-28	30	23	4880	23	91	810	0.94	990	160	2.6	0.4	0.31	0.40
Campbell's Bay	115	-28	-30	30	23	4900	23	96	700	0.83	850	140	2.6	0.4	0.25	0.32
Chambly	20	-24	-26	30	23	4450	23	91	850	0.96	1000	160	2.3	0.4	0.31	0.40
Coaticook	295	-25	-27	28	22	4750	23	96	860	1.00	1060	160	2.3	0.6	0.27	0.35
Contrecoeur	10	-25	-27	30	23	4500	20	102	810	0.94	1000	180	2.8	0.4	0.33	0.43
Cowansville	120	-25	-27	29	23	4540	23	91	940	1.04	1150	160	2.3	0.4	0.32	0.41
Deux-Montagnes	25	-25	-27	29	23	4440	23	96	820	0.92	1025	160	2.4	0.4	0.29	0.37
Dolbeau	120	-32	-34	28	22	6250	22	91	670	0.85	900	140	3.5	0.3	0.27	0.35
Drummondville	85	-26	-28	30	23	4700	22	107	870	0.98	1075	180	2.5	0.4	0.27	0.35
Farnham	60	-24	-26	29	23	4500	23	96	910	1.01	1050	180	2.5	0.4	0.29	0.37
Fort-Coulonge	110	-28	-30	30	23	4950	23	96	720	0.86	900	100	2.5	0.4	0.25	0.32
Gagnon	545	-34	-36	24	19	7600	17	80	580	0.89	925	140	4.6	0.4	0.30	0.39
Gaspé	55	-25	-26	26	20	5500	19	118	760	0.96	1100	300	4.3	0.6	0.37	0.48
Gatineau	95	-25	-28	30	23	4600	23	91	790	0.92	950	160	2.5	0.4	0.32	0.41
Gracefield	175	-28	-31	30	23	5080	23	96	700	0.85	950	140	2.6	0.4	0.25	0.32
Granby	120	-25	-27	29	23	4500	23	102	940	1.04	1175	160	2.3	0.4	0.27	0.35
Harrington-Harbour	30	-27	-29	19	16	6150	15	96	900	1.18	1150	300	4.9	0.6	0.56	0.72
Havre-St-Pierre	5	-27	-29	22	18	6100	15	96	780	1.05	1125	300	4.1	0.6	0.48	0.63
Hemmingford	75	-24	-26	30	23	4380	23	91	770	0.89	1025	160	2.4	0.4	0.31	0.40
Hull	65	-25	-28	30	23	4550	23	91	730	0.84	900	160	2.4	0.4	0.32	0.41
Iberville	35	-24	-26	29	23	4450	23	91	880	0.99	1010	160	2.2	0.4	0.32	0.41
Inukjuak	5	-36	-38	21	15	9150	9	54	270	0.88	420	240	4.1	0.2	0.47	0.60
Joliette	45	-26	-28	29	23	4720	21	102	790	0.93	1000	160	3.1	0.4	0.28	0.36
Kuujuuaq	25	-37	-39	24	17	8550	9	54	280	0.80	525	260	4.8	0.2	0.47	0.60
Kuujuarapik	20	-36	-38	25	17	7990	12	80	410	0.85	610	180	4.2	0.3	0.43	0.55
La Pocatière	55	-24	-26	28	22	5160	18	102	675	0.85	965	180	3.2	0.6	0.39	0.50
La-Malbaie	25	-26	-28	28	21	5400	18	102	640	0.82	900	180	3.1	0.6	0.37	0.48
La-Tuque	165	-30	-32	29	22	5500	23	96	720	0.87	930	160	3.4	0.4	0.27	0.35
Lac-Mégantic	420	-27	-29	27	22	5180	23	91	790	0.94	1025	160	3.2	0.6	0.27	0.35
Lachute	65	-26	-28	29	23	4640	23	96	910	1.04	1075	160	2.4	0.4	0.31	0.40
Lennoxville	155	-28	-30	29	22	4700	23	96	850	0.98	1100	160	2.1	0.6	0.25	0.32
Léry	30	-24	-26	29	23	4420	23	91	800	0.91	950	180	2.3	0.4	0.33	0.42
Loretteville	100	-26	-29	28	22	5200	20	102	980	1.09	1225	200	3.7	0.6	0.32	0.41
Louiseville	15	-25	-28	29	23	4900	20	102	800	0.93	1025	160	2.9	0.4	0.33	0.43
Magog	215	-26	-28	29	23	4730	23	96	860	0.99	1125	160	2.3	0.4	0.27	0.35
Malartic	325	-33	-36	29	21	6200	20	86	640	0.82	900	100	3.3	0.3	0.25	0.32
Maniwaki	180	-30	-32	29	22	5280	23	96	700	0.86	900	100	2.4	0.4	0.24	0.31
Masson	50	-26	-28	30	23	4610	23	91	790	0.92	975	160	2.4	0.4	0.31	0.40

Council, National R. National Building Code 2015. National Research Council.

Province and Location	Elev., m	Design Temperature				De- gree- Days Below 18°C	15 Min. Rain, mm	One Day Rain, 1/50, mm	Ann. Rain, mm	Moist. Index	Ann. Tot. Ppn., mm	Driv- ing Rain Wind Pres- sures, Pa, 1/5	Snow Load, kPa, 1/50		Hourly Wind Pressures, kPa	
		January		July 2.5%									S _s	S _r	1/10	1/50
		2.5% °C	1% °C	Dry °C	Wet °C											
Matane	5	-24	-26	24	20	5510	18	91	640	0.88	1050	220	3.7	0.4	0.47	0.60
Mont-Joli	90	-24	-26	26	21	5370	18	91	610	0.84	920	220	4.1	0.4	0.40	0.52
Mont-Laurier	225	-29	-32	29	22	5320	24	102	790	0.93	1000	160	2.6	0.4	0.23	0.30
Montmagny	10	-25	-28	28	22	5090	20	102	880	1.01	1090	180	2.9	0.6	0.36	0.47
Montréal Region																
Beaconsfield	25	-24	-26	30	23	4440	23	91	780	0.89	950	180	2.3	0.4	0.33	0.42
Dorval	25	-24	-26	30	23	4400	23	91	760	0.85	940	180	2.4	0.4	0.33	0.42
Laval	35	-24	-26	29	23	4500	23	96	830	0.93	1025	160	2.6	0.4	0.33	0.42
Montréal (City Hall)	20	-23	-26	30	23	4200	23	96	830	0.93	1025	180	2.6	0.4	0.33	0.42
Montréal-Est	25	-23	-26	30	23	4470	23	96	830	0.93	1025	180	2.7	0.4	0.33	0.42
Montréal-Nord	20	-24	-26	30	23	4470	23	96	830	0.93	1025	160	2.6	0.4	0.33	0.42
Outremont	105	-23	-26	30	23	4300	23	96	820	0.91	1025	180	2.8	0.4	0.33	0.42
Pierrefonds	25	-24	-26	30	23	4430	23	96	800	0.90	960	180	2.4	0.4	0.33	0.42
St-Lambert	15	-23	-26	30	23	4400	23	96	810	0.91	1050	160	2.5	0.4	0.33	0.42
St-Laurent	45	-23	-26	30	23	4270	23	96	790	0.89	950	160	2.5	0.4	0.33	0.42
Ste-Anne-de-Bellevue	35	-24	-26	29	23	4460	23	96	780	0.89	960	180	2.3	0.4	0.33	0.42
Verdun	20	-23	-26	30	23	4200	23	91	780	0.88	1025	180	2.5	0.4	0.33	0.42
Nicolet (Gentilly)	15	-25	-28	29	23	4900	20	107	860	0.98	1025	160	2.8	0.4	0.33	0.42
Nitchequon	545	-39	-41	23	19	8100	15	70	500	0.89	825	140	3.5	0.3	0.29	0.37
Noranda	305	-33	-36	29	21	6050	20	91	650	0.82	875	100	3.2	0.3	0.27	0.35
Percé	5	-21	-24	25	19	5400	16	107	1000	1.18	1300	300	3.8	0.6	0.56	0.72
Pincourt	25	-24	-26	29	23	4480	23	96	780	0.88	950	180	2.3	0.4	0.33	0.42
Plessisville	145	-26	-28	29	23	5100	21	107	890	1.00	1150	180	2.8	0.6	0.27	0.35
Port-Cartier	20	-28	-30	25	19	6060	15	106	730	0.99	1125	300	4.1	0.4	0.42	0.54
Puvirnitug	5	-36	-38	23	16	9200	7	54	210	0.87	375	240	4.5	0.2	0.47	0.60
Québec City Region																
Ancienne-Lorette	35	-25	-28	28	23	5130	20	102	940	1.06	1200	200	3.4	0.6	0.32	0.41
Lévis	50	-25	-28	28	22	5050	20	107	920	1.04	1200	160	3.3	0.6	0.32	0.41
Québec	120	-25	-28	28	22	5080	20	107	925	1.04	1210	200	3.6	0.6	0.32	0.41
Sillery	10	-25	-28	28	23	5070	20	107	930	1.05	1200	200	3.1	0.6	0.32	0.41
Ste-Foy	115	-25	-28	28	23	5100	20	107	940	1.06	1200	180	3.7	0.6	0.32	0.41
Richmond	150	-25	-27	29	22	4700	23	96	870	0.98	1060	160	2.4	0.6	0.25	0.32
Rimouski	30	-25	-27	26	20	5300	18	91	640	0.84	890	200	3.8	0.4	0.40	0.52
Rivière-du-Loup	55	-25	-27	26	21	5380	18	91	660	0.84	900	180	3.5	0.6	0.39	0.50
Roberval	100	-31	-33	28	21	5750	22	91	590	0.77	910	140	3.5	0.3	0.27	0.35
Rock-Island	160	-25	-27	29	23	4850	23	91	900	1.03	1125	160	2.0	0.4	0.27	0.35
Rosemère	25	-24	-26	29	23	4550	23	96	840	0.97	1050	160	2.6	0.4	0.31	0.40
Rouyn	300	-33	-36	29	21	6050	20	91	650	0.82	900	100	3.1	0.3	0.27	0.35
Saguenay	10	-30	-32	28	22	5700	18	86	710	0.88	975	140	2.7	0.4	0.28	0.36

Council, National R. National Building Code 2015. National Research Council.

Province and Location	Elev., m	Design Temperature				De- gree- Days Below 18°C	15 Min. Rain, mm	One Day Rain, 1/50, mm	Ann. Rain, mm	Moist. Index	Ann. Tot. Ppn., mm	Driv- ing Rain Wind Pres- sures, Pa, 1/5	Snow Load, kPa, 1/50		Hourly Wind Pressures, kPa	
		January		July 2.5%									S _s	S _t	1/10	1/50
		2.5% °C	1% °C	Dry °C	Wet °C											
Saguenay (Bagotville)	5	-31	-33	28	21	5700	18	86	690	0.86	925	160	2.7	0.4	0.29	0.38
Saguenay (Jonquière)	135	-30	-32	28	22	5650	18	86	710	0.87	925	160	3.1	0.4	0.27	0.35
Saguenay (Kenogami)	140	-30	-32	28	22	5650	18	86	690	0.86	925	160	3.1	0.4	0.27	0.35
Saint-Eustache	35	-25	-27	29	23	4500	23	96	820	0.92	1025	160	2.4	0.4	0.29	0.37
Saint-Jean-sur- Richelieu	35	-24	-26	29	23	4450	23	91	880	0.99	1010	180	2.2	0.4	0.32	0.41
Salaberry-de- Valleyfield	50	-23	-25	29	23	4400	23	96	760	0.87	900	180	2.3	0.4	0.33	0.42
Schefferville	550	-37	-39	24	16	8550	13	64	410	0.81	800	180	4.5	0.3	0.33	0.42
Senneterre	310	-34	-36	29	21	6180	22	91	740	0.91	925	100	3.3	0.3	0.25	0.32
Sept-Îles	5	-29	-31	24	18	6200	15	106	760	1.01	1125	300	4.1	0.4	0.42	0.54
Shawinigan	60	-26	-29	29	23	5050	22	102	820	0.96	1050	180	3.1	0.4	0.27	0.35
Shawville	170	-27	-30	30	23	4880	23	96	670	0.79	880	160	2.8	0.4	0.27	0.35
Sherbrooke	185	-28	-30	29	23	4700	23	96	900	1.03	1100	160	2.2	0.6	0.25	0.32
Sorel	10	-25	-27	29	23	4550	20	102	800	0.93	975	180	2.8	0.4	0.33	0.43
St-Félicien	105	-32	-34	28	22	5850	22	91	570	0.76	900	140	3.5	0.3	0.27	0.35
St-Georges-de- Cacouna	35	-25	-27	26	21	5400	18	91	660	0.85	925	180	3.2	0.6	0.39	0.50
St-Hubert	25	-24	-26	30	23	4490	23	91	820	0.92	1020	180	2.5	0.4	0.33	0.42
Saint-Hubert-de- Rivière-du-Loup	310	-26	-28	26	21	5520	22	91	740	0.90	1025	180	4.4	0.6	0.31	0.40
St-Hyacinthe	35	-24	-27	30	23	4500	21	91	840	0.95	1030	160	2.3	0.4	0.27	0.35
St-Jérôme	95	-26	-28	29	23	4820	23	96	830	0.97	1025	160	2.7	0.4	0.29	0.37
St-Jovite	230	-29	-31	28	22	5250	23	96	810	0.99	1025	160	2.8	0.4	0.25	0.33
St-Lazare-Hudson	60	-24	-26	30	23	4520	23	96	750	0.85	950	180	2.3	0.4	0.33	0.42
St-Nicolas	65	-25	-28	28	22	4990	20	102	890	1.01	1200	200	3.5	0.6	0.33	0.42
Ste-Agathe-des- Monts	360	-28	-30	28	22	5390	23	96	820	1.00	1170	140	3.4	0.4	0.27	0.35
Sutton	185	-25	-27	29	23	4600	23	96	990	1.09	1260	160	2.4	0.4	0.32	0.41
Tadoussac	65	-26	-28	27	21	5450	18	96	700	0.88	1000	180	3.7	0.4	0.40	0.52
Témiscaming	240	-30	-32	30	22	5020	23	96	730	0.88	940	100	2.5	0.4	0.25	0.32
Terrebonne	20	-25	-27	29	23	4500	23	96	830	0.93	1025	160	2.6	0.4	0.31	0.40
Thetford Mines	330	-26	-28	28	22	5120	22	107	950	1.06	1230	160	3.5	0.6	0.27	0.35
Thurso	50	-26	-28	30	23	4820	23	91	800	0.93	950	160	2.4	0.4	0.31	0.40
Trois-Rivières	25	-25	-28	29	23	4900	20	107	860	0.98	1050	180	2.8	0.4	0.33	0.43
Val-d'Or	310	-33	-36	29	21	6180	20	86	640	0.83	925	100	3.4	0.3	0.25	0.32
Varennes	15	-24	-26	30	23	4500	23	96	810	0.94	1000	160	2.6	0.4	0.31	0.40
Verchères	15	-24	-26	30	23	4450	23	96	810	0.94	1000	160	2.7	0.4	0.33	0.43
Victoriaville	125	-26	-28	29	23	4900	21	102	850	0.97	1100	180	2.6	0.6	0.27	0.35
Ville-Marie	200	-31	-34	30	22	5550	23	96	630	0.80	825	120	2.3	0.4	0.31	0.40
Wakefield	120	-27	-30	30	23	4820	23	91	780	0.91	1020	160	2.4	0.4	0.27	0.34

Council, National R. National Building Code 2015. National Research Council.

Province and Location	Elev., m	Design Temperature				De- gree- Days Below 18°C	15 Min. Rain, mm	One Day Rain, 1/50, mm	Ann. Rain, mm	Moist. Index	Ann. Tot. Ppn., mm	Driv- ing Rain Wind Pres- sures, Pa, 1/5	Snow Load, kPa, 1/50		Hourly Wind Pressures, kPa	
		January		July 2.5%									S _s	S _t	1/10	1/50
		2.5% °C	1% °C	Dry °C	Wet °C											
Waterloo	205	-25	-27	29	23	4650	23	96	980	1.08	1250	160	2.5	0.4	0.27	0.35
Windsor	150	-25	-27	29	23	4700	23	96	930	1.04	1075	160	2.3	0.4	0.25	0.32
New Brunswick																
Alma	5	-21	-23	26	20	4500	18	144	1175	1.32	1450	260	2.6	0.6	0.37	0.48
Bathurst	10	-23	-26	30	22	5020	20	106	775	0.94	1020	180	4.1	0.6	0.37	0.48
Campbellton	30	-26	-28	29	22	5500	20	107	725	0.93	1025	180	4.3	0.4	0.35	0.45
Edmundston	160	-27	-29	28	22	5320	23	91	750	0.94	1000	160	3.4	0.6	0.29	0.38
Fredericton	15	-24	-27	29	22	4670	22	112	900	1.02	1100	160	3.1	0.6	0.29	0.38
Gagetown	20	-24	-26	29	22	4460	20	112	900	1.04	1125	180	2.8	0.6	0.31	0.40
Grand Falls	115	-27	-30	28	22	5300	23	107	850	1.00	1100	160	3.6	0.6	0.29	0.38
Miramichi	5	-24	-26	30	22	4950	20	96	825	0.97	1050	200	3.4	0.6	0.32	0.41
Moncton	20	-23	-25	28	21	4680	20	112	850	1.02	1175	220	3.0	0.6	0.39	0.50
Oromocto	20	-24	-26	29	22	4650	22	112	900	1.02	1110	160	3.0	0.6	0.30	0.39
Sackville	15	-22	-24	27	21	4590	18	112	975	1.14	1175	220	2.5	0.6	0.38	0.49
Saint Andrews	35	-22	-24	25	20	4680	19	123	1000	1.15	1200	220	2.8	0.6	0.35	0.45
Saint George	35	-21	-23	25	20	4680	18	123	1000	1.15	1200	220	2.8	0.6	0.35	0.45
Saint John	5	-22	-24	25	20	4570	18	139	1100	1.27	1425	260	2.3	0.6	0.41	0.53
Shippagan	5	-22	-24	28	21	4930	18	96	800	0.98	1050	260	3.4	0.6	0.48	0.63
St. Stephen	20	-24	-26	28	22	4700	20	123	1000	1.15	1160	180	2.9	0.6	0.33	0.42
Woodstock	60	-26	-29	30	22	4910	22	107	875	0.99	1100	160	3.1	0.6	0.29	0.37
Nova Scotia																
Amherst	25	-21	-24	27	21	4500	18	118	950	1.12	1150	220	2.4	0.6	0.37	0.48
Antigonish	10	-17	-20	27	21	4510	15	123	1100	1.25	1250	240	2.3	0.6	0.42	0.54
Bridgewater	10	-15	-17	27	20	4140	16	144	1300	1.45	1475	260	1.9	0.6	0.43	0.55
Canso	5	-13	-15	25	20	4400	15	123	1325	1.48	1400	260	1.7	0.6	0.48	0.61
Debert	45	-21	-24	27	21	4500	18	118	1000	1.16	1200	240	2.1	0.6	0.37	0.48
Digby	35	-15	-17	25	20	4020	15	130	1100	1.27	1275	260	2.2	0.6	0.43	0.55
Greenwood (CFB)	28	-18	-20	29	22	4140	16	118	925	1.05	1100	280	2.7	0.6	0.42	0.54
Halifax Region																
Dartmouth	10	-16	-18	26	20	4100	18	144	1250	1.40	1400	280	1.6	0.6	0.45	0.58
Halifax	55	-16	-18	26	20	4000	17	150	1350	1.49	1500	280	1.9	0.6	0.45	0.58
Kentville	25	-18	-20	28	21	4130	17	118	950	1.09	1200	260	2.6	0.6	0.42	0.54
Liverpool	20	-16	-18	27	20	3990	16	150	1325	1.48	1425	280	1.7	0.6	0.48	0.61
Lockeport	5	-14	-16	25	20	4000	18	139	1250	1.42	1450	280	1.4	0.6	0.47	0.60
Louisburg	5	-15	-17	26	20	4530	15	118	1300	1.46	1500	300	2.1	0.7	0.50	0.65
Lunenburg	25	-15	-17	26	20	4140	16	144	1300	1.45	1450	260	1.9	0.6	0.48	0.61
New Glasgow	30	-19	-21	27	21	4320	15	135	975	1.13	1200	260	2.2	0.6	0.43	0.55
North Sydney	20	-16	-19	27	21	4500	15	123	1200	1.36	1475	300	2.4	0.6	0.46	0.59
Pictou	25	-19	-21	27	21	4310	15	107	950	1.11	1175	260	2.2	0.6	0.43	0.55
Port Hawkesbury	40	-17	-19	27	21	4500	15	128	1325	1.48	1450	260	2.1	0.6	0.57	0.74

Council, National R. National Building Code 2015. National Research Council.

Province and Location	Elev., m	Design Temperature				De- gree- Days Below 18°C	15 Min. Rain, mm	One Day Rain, 1/50, mm	Ann. Rain, mm	Moist. Index	Ann. Tot. Ppn., mm	Driv- ing Rain Wind Pres- sures, Pa, 1/5	Snow Load, kPa, 1/50		Hourly Wind Pressures, kPa	
		January		July 2.5%									S _s	S _r	1/10	1/50
		2.5% °C	1% °C	Dry °C	Wet °C											
Springhill	185	-20	-23	27	21	4540	18	118	1075	1.22	1175	220	3.1	0.6	0.37	0.48
Stewiacke	25	-20	-22	27	21	4400	18	128	1050	1.20	1250	240	1.8	0.6	0.39	0.50
Sydney	5	-16	-19	27	21	4530	15	123	1200	1.36	1475	300	2.3	0.6	0.46	0.59
Tatamagouche	25	-20	-23	27	21	4380	18	118	875	1.05	1150	260	2.2	0.6	0.43	0.55
Truro	25	-20	-22	27	21	4500	18	118	1000	1.16	1175	240	2.0	0.6	0.37	0.48
Wolfville	35	-19	-21	28	21	4140	17	118	975	1.13	1175	260	2.6	0.6	0.42	0.54
Yarmouth	10	-14	-16	22	19	3990	19	135	1125	1.32	1260	280	1.8	0.6	0.43	0.56
Prince Edward Island																
Charlottetown	5	-20	-22	26	21	4460	16	107	900	1.09	1150	350	2.7	0.6	0.43	0.56
Souris	5	-19	-21	27	21	4550	15	112	950	1.14	1130	350	2.7	0.6	0.45	0.58
Summerside	10	-20	-22	27	21	4600	16	112	825	1.03	1060	350	3.1	0.6	0.47	0.60
Tignish	10	-20	-22	27	21	4770	16	96	800	1.01	1100	350	3.2	0.6	0.51	0.66
Newfoundland																
Argentia	15	-12	-14	21	18	4600	15	107	1250	1.47	1400	400	2.4	0.7	0.58	0.75
Bonavista	15	-14	-16	24	19	5000	18	96	825	1.11	1010	400	3.1	0.6	0.65	0.84
Buchans	255	-24	-27	27	20	5250	13	107	850	1.04	1125	200	4.7	0.6	0.47	0.60
Cape Harrison	5	-29	-31	26	16	6900	10	106	475	0.94	950	350	6.3	0.4	0.47	0.60
Cape Race	5	-11	-13	19	18	4900	18	130	1425	1.66	1550	400	2.3	0.7	0.81	1.05
Channel-Port aux Basques	5	-13	-15	19	18	5000	13	123	1175	1.43	1520	450	3.6	0.7	0.60	0.78
Corner Brook	35	-16	-18	26	20	4760	13	91	875	1.08	1190	300	3.7	0.6	0.43	0.55
Gander	125	-18	-20	27	20	5110	18	91	775	1.01	1180	280	3.7	0.6	0.47	0.60
Grand Bank	5	-14	-15	20	18	4550	15	123	1350	1.58	1525	400	2.4	0.7	0.57	0.74
Grand Falls	60	-26	-29	27	20	5020	15	86	775	0.97	1030	240	3.4	0.6	0.47	0.60
Happy Valley-Goose Bay	15	-31	-32	27	19	6670	18	80	575	0.83	960	160	5.3	0.4	0.33	0.42
Labrador City	550	-36	-38	24	17	7710	15	70	500	0.82	880	140	4.8	0.3	0.31	0.40
St. Anthony	10	-25	-27	22	18	6440	13	86	800	1.07	1280	450	6.1	0.6	0.67	0.87
St. John's	65	-15	-16	24	20	4800	18	118	1200	1.41	1575	400	2.9	0.7	0.60	0.78
Stephenville	25	-16	-18	24	19	4850	14	102	1000	1.19	1275	350	4.1	0.6	0.45	0.58
Twin Falls	425	-35	-37	24	17	7790	15	70	500	0.85	950	120	4.8	0.4	0.31	0.40
Wabana	75	-15	-17	24	20	4750	18	112	1125	1.34	1500	400	3.0	0.7	0.58	0.75
Wabush	550	-36	-38	24	17	7710	15	70	500	0.82	880	140	4.8	0.3	0.31	0.40
Yukon																
Aishihik	920	-44	-46	23	15	7500	8	43	190	0.57	275	40	1.9	0.1	0.29	0.38
Dawson	330	-50	-51	26	16	8120	10	49	200	0.57	350	40	2.9	0.1	0.24	0.31
Destruction Bay	815	-43	-45	23	14	7800	8	49	190	0.62	300	80	1.9	0.1	0.47	0.60
Faro	670	-46	-47	25	16	7300	10	33	215	0.58	315	40	2.3	0.1	0.27	0.35
Haines Junction	600	-45	-47	24	14	7100	8	51	145	0.56	315	180	2.2	0.1	0.26	0.34
Snag	595	-51	-53	23	16	8300	8	59	290	0.57	350	40	2.2	0.1	0.24	0.31
Teslin	690	-42	-44	24	15	6770	10	38	200	0.51	340	40	3.0	0.1	0.26	0.34

Council, National R. National Building Code 2015. National Research Council.

Province and Location	Elev., m	Design Temperature				De- gree- Days Below 18°C	15 Min. Rain, mm	One Day Rain, 1/50, mm	Ann. Rain, mm	Moist. Index	Ann. Tot. Ppn., mm	Driv- ing Rain Wind Pres- sures, Pa, 1/5	Snow Load, kPa, 1/50		Hourly Wind Pressures, kPa	
		January		July 2.5%									S _s	S _r	1/10	1/50
		2.5% °C	1% °C	Dry °C	Wet °C											
Watson Lake	685	-46	-48	26	16	7470	10	54	250	0.55	410	60	3.2	0.1	0.27	0.35
Whitehorse	655	-41	-43	25	15	6580	8	43	170	0.49	275	40	2.0	0.1	0.29	0.38
Northwest Territories																
Aklavik	5	-42	-44	26	17	9600	6	49	115	0.67	250	60	2.8	0.1	0.37	0.48
Echo Bay / Port Radium	195	-42	-44	22	16	9300	8	60	160	0.70	250	80	3.0	0.1	0.41	0.53
Fort Good Hope	100	-43	-45	28	18	8700	9	60	140	0.60	280	80	2.9	0.1	0.34	0.44
Fort McPherson	25	-44	-46	26	17	9150	6	50	145	0.67	315	60	3.2	0.1	0.31	0.40
Fort Providence	150	-40	-43	28	18	7620	10	71	210	0.56	350	100	2.4	0.1	0.27	0.35
Fort Resolution	160	-40	-42	26	18	7750	10	60	175	0.61	300	140	2.3	0.1	0.30	0.39
Fort Simpson	120	-42	-44	28	19	7660	12	76	225	0.56	360	80	2.3	0.1	0.30	0.39
Fort Smith	205	-41	-43	28	19	7300	10	65	250	0.56	350	80	2.3	0.2	0.30	0.39
Hay River	45	-38	-41	27	18	7550	10	60	200	0.62	150	140	2.4	0.1	0.27	0.35
Holman/ Ulukhaqtuuq	10	-39	-41	18	12	10700	3	44	80	0.93	250	120	2.1	0.1	0.66	0.86
Inuvik	45	-43	-45	26	17	9600	6	49	115	0.67	425	60	3.1	0.1	0.37	0.48
Mould Bay	5	-44	-46	11	8	12900	3	33	25	0.94	100	140	1.5	0.1	0.45	0.58
Norman Wells	65	-43	-45	28	18	8510	9	60	165	0.57	320	80	3.0	0.1	0.34	0.44
Rae-Edzo	160	-42	-44	25	17	8300	10	60	175	0.59	275	80	2.3	0.1	0.36	0.47
Tungsten	1340	-49	-51	26	16	7700	10	44	315	0.75	640	40	4.3	0.1	0.34	0.44
Wrigley	80	-42	-44	28	18	8050	10	54	220	0.58	350	80	2.8	0.1	0.30	0.39
Yellowknife	160	-41	-44	25	17	8170	10	60	175	0.58	275	100	2.2	0.1	0.36	0.47
Nunavut																
Alert	5	-43	-44	13	8	13030	3	22	20	0.95	150	100	2.6	0.1	0.58	0.75
Arctic Bay	15	-42	-44	14	10	11900	3	38	60	0.90	150	160	2.4	0.1	0.43	0.55
Arviat / Eskimo Point	5	-40	-41	22	16	9850	8	65	225	0.85	300	240	3.0	0.2	0.45	0.58
Baker Lake	5	-42	-44	23	15	10700	5	55	160	0.84	260	180	3.4	0.2	0.42	0.54
Cambridge Bay/Iqaluktuuttiaq	15	-41	-44	18	13	11670	4	38	70	0.89	140	100	1.9	0.1	0.42	0.54
Chesterfield Inlet/Igluligaarjuk	10	-40	-41	20	14	10500	5	60	175	0.88	270	240	3.6	0.2	0.43	0.56
Clyde River /Kanngiqtugaapik	5	-40	-42	14	10	11300	5	44	55	0.90	225	220	4.2	0.2	0.56	0.72
Coppermine (Kugluktuk)	10	-41	-43	23	16	10300	6	65	140	0.84	150	80	3.4	0.1	0.36	0.46
Coral Harbour /Salliq	15	-41	-42	20	14	10720	5	65	150	0.87	280	200	3.8	0.2	0.54	0.69
Eureka	5	-47	-48	12	8	13500	3	27	25	0.95	70	100	1.6	0.1	0.43	0.55
Iqaluit	45	-40	-41	17	12	9980	5	58	200	0.86	433	200	2.9	0.2	0.45	0.58
Isachsen	10	-46	-48	12	9	13600	3	27	25	0.95	75	140	1.9	0.1	0.47	0.60
Nottingham Island	30	-37	-39	16	13	10000	5	54	175	0.88	325	200	4.7	0.2	0.60	0.78
Rankin Inlet (Kangiqiniq)	10	-41	-42	21	15	10500	5	65	180	0.87	250	240	3.0	0.2	0.47	0.60

Council, National R. National Building Code 2015. National Research Council.

Province and Location	Elev., m	Design Temperature				De- gree- Days Below 18°C	15 Min. Rain, mm	One Day Rain, 1/50, mm	Ann. Rain, mm	Moist. Index	Ann. Tot. Ppn., mm	Driv- ing Rain Wind Pres- sures, Pa, 1/5	Snow Load, kPa, 1/50		Hourly Wind Pressures, kPa	
		January		July 2.5%									S _s	S _r	1/10	1/50
		2.5% °C	1% °C	Dry °C	Wet °C											
Resolute	25	-42	-43	11	9	12360	3	27	50	0.93	140	180	2.0	0.1	0.54	0.69
Resolution Island	5	-32	-34	12	10	9000	5	71	240	0.89	550	200	5.5	0.2	0.95	1.23

Council, National R. National Building Code 2015. National Research Council.

ICFMA

INSULATING CONCRETE FORMS
MANUFACTURERS ASSOCIATION
ICF-MA.ORG

Appendix C: Seismic Design Data for Selected Locations in Canada

Table C-3
Seismic Design Data for Selected Locations in Canada

Province and Location	Seismic Data							
	$S_a(0.2)$	$S_a(0.5)$	$S_a(1.0)$	$S_a(2.0)$	$S_a(5.0)$	$S_a(10.0)$	PGA	PGV
British Columbia								
100 Mile House	0.140	0.113	0.083	0.058	0.027	0.0080	0.064	0.109
Abbotsford	0.701	0.597	0.350	0.215	0.071	0.025	0.306	0.445
Agassiz	0.457	0.384	0.244	0.157	0.057	0.020	0.206	0.306
Alberni	0.955	0.915	0.594	0.373	0.124	0.044	0.434	0.683
Ashcroft	0.198	0.160	0.115	0.078	0.034	0.011	0.092	0.149
Bamfield	1.44	1.35	0.871	0.525	0.167	0.059	0.682	0.931
Beaton River	0.132	0.083	0.049	0.026	0.0083	0.0037	0.079	0.056
Bella Bella	0.208	0.232	0.187	0.129	0.049	0.017	0.103	0.286
Bella Coola	0.163	0.172	0.143	0.105	0.043	0.014	0.083	0.225
Burns Lake	0.095	0.080	0.066	0.052	0.024	0.0076	0.043	0.111
Cache Creek	0.195	0.157	0.112	0.077	0.034	0.010	0.090	0.148
Campbell River	0.595	0.582	0.408	0.265	0.094	0.034	0.283	0.487
Carmi	0.141	0.120	0.090	0.062	0.028	0.0086	0.065	0.111
Castlegar	0.129	0.100	0.074	0.048	0.022	0.0069	0.058	0.085
Chetwynd	0.176	0.121	0.068	0.033	0.013	0.0045	0.082	0.071

National Building Code of Canada 2015 Volume 1, Division B

INSULATING CONCRETE FORMS
MANUFACTURERS ASSOCIATION
ICF-MA.ORG

Table C-3 (Continued)

Province and Location	Seismic Data							
	S _a (0.2)	S _a (0.5)	S _a (1.0)	S _a (2.0)	S _a (5.0)	S _a (10.0)	PGA	PGV
Chilliwack	0.539	0.448	0.277	0.174	0.062	0.021	0.242	0.347
Comox	0.685	0.662	0.455	0.292	0.102	0.036	0.317	0.538
Courtenay	0.692	0.670	0.461	0.296	0.104	0.037	0.321	0.545
Cranbrook	0.170	0.138	0.089	0.047	0.018	0.0062	0.075	0.085
Crescent Valley	0.130	0.101	0.073	0.047	0.021	0.0067	0.058	0.082
Crofton	1.13	1.04	0.598	0.358	0.111	0.039	0.491	0.754
Dawson Creek	0.150	0.098	0.055	0.026	0.0080	0.0032	0.080	0.059
Dease Lake	0.103	0.091	0.074	0.049	0.017	0.0067	0.044	0.078
Dog Creek	0.172	0.140	0.102	0.071	0.032	0.0098	0.079	0.140
Duncan	1.17	1.09	0.631	0.378	0.118	0.042	0.513	0.786
Elko	0.217	0.174	0.108	0.053	0.019	0.0066	0.098	0.101
Fernie	0.234	0.175	0.106	0.052	0.019	0.0065	0.106	0.101
Fort Nelson	0.141	0.103	0.068	0.036	0.012	0.0049	0.081	0.071
Fort St. John	0.145	0.094	0.053	0.026	0.0077	0.0032	0.079	0.058
Glacier	0.206	0.142	0.081	0.044	0.018	0.0058	0.093	0.083
Gold River	1.01	0.988	0.664	0.413	0.135	0.048	0.466	0.743
Golden	0.263	0.174	0.094	0.046	0.017	0.0056	0.120	0.095
Grand Forks	0.133	0.108	0.082	0.056	0.026	0.0079	0.061	0.101
Greenwood	0.136	0.113	0.085	0.059	0.027	0.0082	0.063	0.105
Hope	0.363	0.304	0.201	0.131	0.051	0.017	0.167	0.251
Jordan River	1.40	1.31	0.817	0.495	0.157	0.055	0.639	0.923
Kamloops	0.146	0.123	0.091	0.064	0.029	0.0087	0.067	0.117
Kaslo	0.142	0.109	0.073	0.043	0.019	0.0062	0.063	0.076
Kelowna	0.143	0.122	0.091	0.063	0.029	0.0087	0.066	0.115
Kimberley	0.165	0.130	0.084	0.045	0.018	0.0060	0.073	0.080
Kitimat Plant	0.161	0.167	0.137	0.096	0.036	0.012	0.080	0.224
Kitimat Townsite	0.161	0.167	0.137	0.096	0.036	0.012	0.080	0.224
Ladysmith	1.10	1.02	0.587	0.353	0.110	0.039	0.482	0.738
Langford	1.32	1.19	0.697	0.415	0.130	0.045	0.590	0.852
Lillooet	0.285	0.214	0.145	0.096	0.040	0.013	0.132	0.188
Lytton	0.292	0.228	0.155	0.103	0.042	0.013	0.136	0.197
Mackenzie	0.165	0.117	0.066	0.036	0.015	0.0052	0.074	0.078
Masset	0.791	0.744	0.496	0.283	0.083	0.029	0.364	0.632
McBride	0.253	0.165	0.089	0.044	0.018	0.0056	0.117	0.097
McLeod Lake	0.153	0.110	0.064	0.037	0.016	0.0053	0.068	0.078
Merritt	0.211	0.175	0.125	0.085	0.037	0.011	0.098	0.160
Mission City	0.644	0.550	0.327	0.204	0.069	0.024	0.283	0.419
Montrose	0.129	0.102	0.075	0.049	0.022	0.0069	0.058	0.086
Nakusp	0.135	0.102	0.070	0.045	0.020	0.0063	0.060	0.079
Nanaimo	1.02	0.942	0.542	0.328	0.104	0.037	0.446	0.684
Nelson	0.131	0.103	0.073	0.046	0.020	0.0065	0.058	0.080
Ocean Falls	0.180	0.199	0.163	0.117	0.046	0.015	0.091	0.258

Table C-3 (Continued)

Province and Location	Seismic Data							
	S _a (0.2)	S _a (0.5)	S _a (1.0)	S _a (2.0)	S _a (5.0)	S _a (10.0)	PGA	PGV
Osoyoos	0.175	0.150	0.110	0.075	0.033	0.010	0.081	0.138
Parksville	0.917	0.859	0.519	0.322	0.106	0.038	0.405	0.639
Penticton	0.159	0.138	0.101	0.070	0.031	0.0096	0.074	0.129
Port Alberni	0.987	0.946	0.614	0.383	0.126	0.045	0.450	0.702
Port Alice	1.60	1.27	0.759	0.412	0.128	0.042	0.689	0.868
Port Hardy	0.700	0.659	0.447	0.272	0.091	0.032	0.320	0.543
Port McNeill	0.711	0.678	0.464	0.285	0.096	0.034	0.326	0.557
Port Renfrew	1.44	1.35	0.850	0.511	0.162	0.057	0.668	0.939
Powell River	0.595	0.556	0.373	0.242	0.086	0.031	0.273	0.457
Prince George	0.113	0.089	0.059	0.040	0.019	0.0059	0.049	0.079
Prince Rupert	0.246	0.269	0.209	0.135	0.046	0.016	0.117	0.314
Princeton	0.259	0.209	0.144	0.096	0.040	0.012	0.121	0.182
Qualicum Beach	0.888	0.838	0.517	0.323	0.108	0.038	0.395	0.629
Queen Charlotte City	1.62	1.37	0.842	0.452	0.124	0.041	0.757	0.989
Quesnel	0.105	0.088	0.065	0.047	0.022	0.0069	0.047	0.091
Revelstoke	0.145	0.109	0.070	0.043	0.019	0.0062	0.064	0.078
Salmon Arm	0.131	0.104	0.075	0.052	0.024	0.0073	0.059	0.093
Sandspit	1.31	1.16	0.724	0.396	0.110	0.036	0.603	0.868
Sechelt	0.828	0.745	0.434	0.265	0.086	0.030	0.363	0.555
Sidney	1.23	1.10	0.630	0.371	0.115	0.040	0.545	0.790
Smith River	0.705	0.447	0.234	0.100	0.028	0.0096	0.354	0.255
Smithers	0.100	0.090	0.076	0.058	0.025	0.0082	0.047	0.134
Sooke	1.34	1.24	0.752	0.456	0.144	0.050	0.605	0.885
Squamish	0.600	0.517	0.314	0.200	0.069	0.024	0.266	0.404
Stewart	0.139	0.132	0.111	0.078	0.029	0.010	0.068	0.180
Tahsis	1.35	1.19	0.767	0.456	0.144	0.050	0.622	0.852
Taylor	0.143	0.093	0.052	0.025	0.0076	0.0031	0.079	0.058
Terrace	0.146	0.145	0.120	0.085	0.032	0.011	0.072	0.200
Tofino	1.46	1.36	0.891	0.536	0.170	0.060	0.695	0.945
Trail	0.129	0.101	0.075	0.050	0.022	0.0070	0.058	0.087
Ucluelet	1.48	1.38	0.897	0.539	0.171	0.060	0.708	0.949
Vancouver Region								
Burnaby (Simon Fraser Univ.)	0.768	0.673	0.386	0.236	0.076	0.027	0.333	0.500
Cloverdale	0.800	0.702	0.400	0.243	0.077	0.027	0.347	0.519
Haney	0.691	0.602	0.352	0.217	0.071	0.025	0.301	0.452
Ladner	0.924	0.827	0.461	0.276	0.085	0.030	0.399	0.601
Langley	0.772	0.674	0.387	0.236	0.076	0.027	0.335	0.500
New Westminster	0.800	0.704	0.401	0.244	0.077	0.027	0.347	0.522
North Vancouver	0.794	0.699	0.399	0.243	0.077	0.027	0.345	0.518
Richmond	0.885	0.787	0.443	0.266	0.083	0.029	0.383	0.578
Surrey (88 Ave & 156 St.)	0.786	0.690	0.394	0.240	0.076	0.027	0.341	0.511
Vancouver (City Hall)	0.848	0.751	0.425	0.257	0.080	0.029	0.369	0.553

Table C-3 (Continued)

Province and Location	Seismic Data							
	S _a (0.2)	S _a (0.5)	S _a (1.0)	S _a (2.0)	S _a (5.0)	S _a (10.0)	PGA	PGV
Vancouver (Granville & 41 Ave)	0.863	0.765	0.432	0.261	0.081	0.029	0.375	0.563
West Vancouver	0.818	0.721	0.410	0.250	0.079	0.028	0.356	0.534
Vernon	0.133	0.108	0.080	0.056	0.025	0.0077	0.061	0.099
Victoria Region								
Victoria (Gonzales Hts)	1.30	1.15	0.668	0.394	0.123	0.043	0.576	0.829
Victoria (Mt Tolmie)	1.29	1.14	0.662	0.390	0.121	0.042	0.573	0.824
Victoria	1.30	1.16	0.676	0.399	0.125	0.044	0.580	0.834
Whistler	0.438	0.357	0.233	0.152	0.058	0.020	0.203	0.296
White Rock	0.868	0.765	0.432	0.260	0.081	0.029	0.376	0.562
Williams Lake	0.136	0.110	0.081	0.057	0.027	0.0080	0.062	0.110
Youbou	1.20	1.13	0.678	0.414	0.131	0.046	0.536	0.816
Alberta								
Athabasca	0.068	0.043	0.027	0.014	0.0041	0.0018	0.039	0.031
Banff	0.279	0.184	0.099	0.046	0.016	0.0053	0.128	0.097
Barrhead	0.105	0.064	0.038	0.019	0.0055	0.0024	0.065	0.046
Beaverlodge	0.153	0.102	0.057	0.028	0.0090	0.0035	0.081	0.062
Brooks	0.116	0.076	0.051	0.028	0.0089	0.0042	0.072	0.056
Calgary	0.192	0.126	0.072	0.036	0.012	0.0048	0.098	0.075
Campsie	0.113	0.067	0.040	0.020	0.0058	0.0024	0.070	0.048
Camrose	0.095	0.058	0.035	0.018	0.0052	0.0022	0.058	0.042
Canmore	0.278	0.183	0.098	0.046	0.016	0.0053	0.128	0.097
Cardston	0.273	0.203	0.122	0.058	0.018	0.0066	0.131	0.118
Claresholm	0.217	0.148	0.090	0.044	0.015	0.0056	0.107	0.089
Cold Lake	0.055	0.034	0.019	0.0078	0.0016	0.0008	0.032	0.023
Coleman	0.279	0.195	0.114	0.054	0.019	0.0065	0.128	0.110
Coronation	0.075	0.048	0.029	0.015	0.0046	0.0020	0.044	0.034
Cowley	0.282	0.198	0.116	0.055	0.018	0.0065	0.130	0.113
Drumheller	0.122	0.077	0.048	0.026	0.0080	0.0037	0.075	0.055
Edmonton	0.103	0.062	0.036	0.018	0.0053	0.0022	0.064	0.044
Edson	0.165	0.111	0.062	0.030	0.0089	0.0035	0.087	0.066
Embarras Portage	0.052	0.031	0.016	0.0065	0.0013	0.0007	0.030	0.020
Fairview	0.121	0.071	0.041	0.020	0.0059	0.0025	0.075	0.051
Fort MacLeod	0.225	0.160	0.097	0.047	0.015	0.0058	0.111	0.095
Fort McMurray	0.053	0.034	0.018	0.0078	0.0016	0.0008	0.031	0.023
Fort Saskatchewan	0.086	0.053	0.032	0.017	0.0050	0.0021	0.052	0.038
Fort Vermilion	0.056	0.036	0.019	0.0081	0.0018	0.0008	0.032	0.024
Grande Prairie	0.141	0.093	0.053	0.026	0.0074	0.0031	0.079	0.058
Habay	0.068	0.045	0.033	0.020	0.0067	0.0031	0.040	0.036
Hardisty	0.068	0.043	0.027	0.014	0.0041	0.0018	0.040	0.031
High River	0.203	0.134	0.079	0.039	0.013	0.0052	0.101	0.079
Hinton	0.280	0.182	0.096	0.043	0.015	0.0048	0.131	0.097
Jasper	0.287	0.190	0.101	0.046	0.017	0.0052	0.132	0.101

Table C-3 (Continued)

Province and Location	Seismic Data							
	S _a (0.2)	S _a (0.5)	S _a (1.0)	S _a (2.0)	S _a (5.0)	S _a (10.0)	PGA	PGV
Keg River	0.067	0.042	0.025	0.012	0.0034	0.0015	0.039	0.030
Lac la Biche	0.059	0.038	0.023	0.011	0.0033	0.0015	0.034	0.027
Lacombe	0.127	0.081	0.047	0.023	0.0065	0.0027	0.077	0.055
Lethbridge	0.164	0.125	0.081	0.042	0.013	0.0053	0.087	0.079
Manning	0.081	0.049	0.029	0.015	0.0046	0.0020	0.048	0.036
Medicine Hat	0.083	0.060	0.045	0.026	0.0083	0.0039	0.050	0.047
Peace River	0.098	0.058	0.034	0.017	0.0052	0.0022	0.061	0.043
Pincher Creek	0.284	0.202	0.119	0.056	0.019	0.0066	0.132	0.115
Ranfurly	0.066	0.042	0.026	0.013	0.0039	0.0018	0.038	0.030
Red Deer	0.131	0.085	0.049	0.024	0.0067	0.0028	0.078	0.056
Rocky Mountain House	0.174	0.116	0.065	0.030	0.0090	0.0035	0.090	0.067
Slave Lake	0.075	0.047	0.029	0.015	0.0046	0.0020	0.044	0.034
Stettler	0.109	0.066	0.039	0.019	0.0056	0.0024	0.067	0.047
Stony Plain	0.115	0.069	0.040	0.020	0.0058	0.0025	0.071	0.050
Suffield	0.099	0.068	0.049	0.028	0.0087	0.0041	0.060	0.052
Taber	0.134	0.101	0.069	0.036	0.012	0.0049	0.079	0.070
Turner Valley	0.253	0.164	0.091	0.043	0.015	0.0053	0.122	0.093
Valleyview	0.126	0.078	0.045	0.022	0.0064	0.0027	0.077	0.054
Vegreville	0.069	0.044	0.027	0.014	0.0041	0.0018	0.040	0.031
Vermilion	0.060	0.038	0.023	0.012	0.0034	0.0015	0.035	0.027
Wagner	0.077	0.048	0.030	0.015	0.0046	0.0020	0.046	0.035
Wainwright	0.062	0.040	0.025	0.012	0.0037	0.0017	0.036	0.028
Wetaskiwin	0.115	0.069	0.040	0.020	0.0058	0.0024	0.071	0.048
Whitecourt	0.125	0.079	0.046	0.023	0.0064	0.0027	0.076	0.054
Wimborne	0.133	0.087	0.052	0.027	0.0081	0.0037	0.078	0.058
Saskatchewan								
Assiniboia	0.136	0.076	0.038	0.016	0.0034	0.0014	0.084	0.054
Batrum	0.065	0.042	0.024	0.012	0.0031	0.0015	0.037	0.030
Biggar	0.057	0.037	0.021	0.0088	0.0019	0.0010	0.033	0.025
Broadview	0.077	0.048	0.025	0.010	0.0022	0.0011	0.045	0.034
Dafoe	0.062	0.040	0.022	0.0089	0.0019	0.0010	0.036	0.027
Dundurn	0.059	0.039	0.022	0.0092	0.0019	0.0010	0.034	0.027
Estevan	0.129	0.072	0.035	0.015	0.0031	0.0013	0.079	0.051
Hudson Bay	0.055	0.034	0.019	0.0079	0.0016	0.0008	0.032	0.023
Humboldt	0.058	0.037	0.020	0.0085	0.0018	0.0010	0.033	0.025
Island Falls	0.054	0.031	0.016	0.0065	0.0013	0.0007	0.031	0.021
Kamsack	0.058	0.037	0.020	0.0085	0.0018	0.0010	0.033	0.025
Kindersley	0.060	0.039	0.024	0.012	0.0033	0.0015	0.035	0.028
Lloydminster	0.057	0.036	0.021	0.010	0.0030	0.0015	0.033	0.025
Maple Creek	0.069	0.048	0.036	0.021	0.0068	0.0032	0.040	0.039
Meadow Lake	0.055	0.034	0.018	0.0075	0.0016	0.0008	0.032	0.023
Melfort	0.055	0.035	0.019	0.0081	0.0018	0.0010	0.032	0.024
Melville	0.069	0.044	0.023	0.0097	0.0021	0.0011	0.040	0.031

National Building Code of Canada 2015 Volume 1, Division B

Table C-3 (Continued)

Province and Location	Seismic Data							
	S _a (0.2)	S _a (0.5)	S _a (1.0)	S _a (2.0)	S _a (5.0)	S _a (10.0)	PGA	PGV
Moose Jaw	0.096	0.058	0.030	0.013	0.0027	0.0013	0.057	0.042
Nipawin	0.054	0.034	0.018	0.0078	0.0016	0.0008	0.032	0.023
North Battleford	0.056	0.036	0.020	0.0085	0.0018	0.0010	0.032	0.024
Prince Albert	0.055	0.034	0.019	0.0078	0.0016	0.0008	0.032	0.023
Qu'Appelle	0.090	0.054	0.028	0.012	0.0025	0.0011	0.054	0.039
Regina	0.101	0.060	0.030	0.013	0.0027	0.0013	0.061	0.043
Rosetown	0.059	0.038	0.022	0.0091	0.0019	0.0010	0.034	0.027
Saskatoon	0.057	0.037	0.021	0.0089	0.0019	0.0010	0.033	0.025
Scott	0.057	0.037	0.020	0.0086	0.0019	0.0010	0.033	0.025
Strasbourg	0.074	0.046	0.025	0.010	0.0022	0.0011	0.043	0.032
Swift Current	0.070	0.045	0.025	0.012	0.0030	0.0014	0.040	0.032
Uranium City	0.053	0.032	0.016	0.0066	0.0013	0.0007	0.031	0.021
Weyburn	0.186	0.097	0.045	0.018	0.0039	0.0014	0.118	0.070
Yorkton	0.063	0.040	0.022	0.0091	0.0019	0.0010	0.036	0.028
Manitoba								
Beausejour	0.056	0.033	0.017	0.0067	0.0015	0.0007	0.032	0.021
Boissevain	0.059	0.037	0.020	0.0082	0.0018	0.0010	0.034	0.025
Brandon	0.054	0.031	0.016	0.0063	0.0013	0.0007	0.031	0.020
Churchill	0.053	0.032	0.017	0.0069	0.0015	0.0008	0.031	0.021
Dauphin	0.055	0.035	0.019	0.0079	0.0018	0.0010	0.032	0.024
Flin Flon	0.054	0.032	0.016	0.0065	0.0013	0.0007	0.031	0.021
Gimli	0.055	0.032	0.017	0.0067	0.0015	0.0007	0.032	0.021
Island Lake	0.054	0.033	0.017	0.0070	0.0015	0.0008	0.031	0.021
Lac du Bonnet	0.056	0.033	0.017	0.0067	0.0015	0.0007	0.033	0.023
Lynn Lake	0.053	0.032	0.016	0.0066	0.0013	0.0007	0.031	0.021
Morden	0.053	0.031	0.015	0.0063	0.0013	0.0007	0.031	0.020
Neepawa	0.054	0.031	0.016	0.0065	0.0013	0.0007	0.031	0.021
Pine Falls	0.056	0.033	0.017	0.0067	0.0015	0.0007	0.032	0.021
Portage la Prairie	0.054	0.032	0.016	0.0065	0.0013	0.0007	0.031	0.021
Rivers	0.058	0.037	0.020	0.0084	0.0018	0.0010	0.034	0.025
Sandilands	0.055	0.032	0.016	0.0065	0.0013	0.0007	0.032	0.021
Selkirk	0.055	0.032	0.016	0.0066	0.0013	0.0007	0.032	0.021
Split Lake	0.053	0.032	0.017	0.0067	0.0015	0.0007	0.031	0.021
Steinbach	0.055	0.032	0.016	0.0065	0.0013	0.0007	0.032	0.021
Swan River	0.055	0.035	0.019	0.0079	0.0018	0.0008	0.032	0.024
The Pas	0.054	0.032	0.016	0.0065	0.0013	0.0007	0.031	0.021
Thompson	0.053	0.032	0.017	0.0067	0.0015	0.0007	0.031	0.021
Virden	0.064	0.041	0.022	0.0089	0.0019	0.0010	0.037	0.028
Winnipeg	0.054	0.032	0.016	0.0066	0.0013	0.0007	0.032	0.021
Ontario								
Ailsa Craig	0.095	0.064	0.039	0.020	0.0049	0.0021	0.056	0.050
Ajax	0.210	0.114	0.060	0.029	0.0071	0.0028	0.134	0.091

Table C-3 (Continued)

Province and Location	Seismic Data							
	S _a (0.2)	S _a (0.5)	S _a (1.0)	S _a (2.0)	S _a (5.0)	S _a (10.0)	PGA	PGV
Alexandria	0.589	0.309	0.148	0.068	0.018	0.0062	0.376	0.255
Alliston	0.111	0.076	0.046	0.024	0.0059	0.0025	0.066	0.060
Almonte	0.337	0.188	0.098	0.048	0.013	0.0049	0.215	0.157
Armstrong	0.064	0.037	0.019	0.0081	0.0018	0.0008	0.038	0.025
Arnprior	0.371	0.201	0.102	0.049	0.013	0.0049	0.238	0.168
Atikokan	0.069	0.038	0.018	0.0072	0.0015	0.0007	0.041	0.025
Attawapiskat	0.074	0.043	0.022	0.0092	0.0019	0.0010	0.045	0.030
Aurora	0.138	0.087	0.050	0.026	0.0064	0.0027	0.085	0.068
Bancroft	0.151	0.105	0.063	0.032	0.0084	0.0035	0.090	0.085
Barrie	0.108	0.077	0.047	0.025	0.0061	0.0025	0.063	0.060
Barriefield	0.162	0.110	0.066	0.034	0.0089	0.0038	0.098	0.091
Beaverton	0.117	0.082	0.050	0.026	0.0065	0.0028	0.069	0.064
Belleville	0.162	0.105	0.061	0.031	0.0080	0.0034	0.100	0.087
Belmont	0.116	0.073	0.042	0.021	0.0053	0.0021	0.070	0.056
Kitchenuhmay-koosib (Big Trout Lake)	0.054	0.033	0.017	0.0072	0.0015	0.0008	0.032	0.023
CFB Borden	0.107	0.075	0.046	0.024	0.0059	0.0025	0.063	0.059
Bracebridge	0.116	0.084	0.051	0.027	0.0068	0.0028	0.068	0.067
Bradford	0.123	0.081	0.048	0.025	0.0062	0.0027	0.074	0.063
Brampton	0.168	0.096	0.052	0.026	0.0064	0.0025	0.106	0.074
Brantford	0.155	0.089	0.049	0.024	0.0059	0.0024	0.097	0.068
Brighton	0.173	0.106	0.060	0.030	0.0076	0.0032	0.108	0.087
Brockville	0.259	0.157	0.086	0.043	0.011	0.0046	0.164	0.131
Burk's Falls	0.143	0.096	0.057	0.029	0.0074	0.0031	0.086	0.076
Burlington	0.266	0.131	0.062	0.029	0.0068	0.0027	0.172	0.102
Cambridge	0.141	0.084	0.047	0.024	0.0058	0.0024	0.088	0.066
Campbellford	0.144	0.097	0.058	0.030	0.0076	0.0032	0.088	0.078
Cannington	0.122	0.084	0.051	0.027	0.0067	0.0028	0.073	0.067
Carleton Place	0.302	0.175	0.093	0.046	0.012	0.0048	0.192	0.146
Cavan	0.140	0.092	0.055	0.028	0.0071	0.0030	0.086	0.074
Centralia	0.092	0.064	0.039	0.020	0.0050	0.0021	0.054	0.050
Chapleau	0.071	0.050	0.031	0.016	0.0037	0.0017	0.041	0.039
Chatham	0.112	0.070	0.039	0.019	0.0047	0.0020	0.068	0.054
Chesley	0.083	0.062	0.040	0.021	0.0052	0.0022	0.047	0.050
Clinton	0.084	0.061	0.038	0.020	0.0049	0.0021	0.048	0.048
Coboconk	0.120	0.086	0.052	0.027	0.0070	0.0030	0.070	0.068
Cobourg	0.179	0.106	0.059	0.030	0.0074	0.0031	0.113	0.086
Cochrane	0.222	0.107	0.052	0.024	0.0058	0.0022	0.145	0.083
Colborne	0.176	0.106	0.060	0.030	0.0076	0.0031	0.111	0.087
Collingwood	0.096	0.070	0.044	0.023	0.0058	0.0024	0.055	0.056
Cornwall	0.587	0.307	0.147	0.067	0.017	0.0060	0.375	0.254
Corunna	0.087	0.060	0.036	0.018	0.0046	0.0020	0.050	0.047
Deep River	0.389	0.208	0.104	0.049	0.013	0.0048	0.250	0.172

Table C-3 (Continued)

Province and Location	Seismic Data							
	S _a (0.2)	S _a (0.5)	S _a (1.0)	S _a (2.0)	S _a (5.0)	S _a (10.0)	PGA	PGV
Deseronto	0.158	0.106	0.062	0.032	0.0081	0.0035	0.096	0.087
Dorchester	0.112	0.072	0.042	0.021	0.0052	0.0021	0.067	0.056
Dorion	0.059	0.035	0.018	0.0076	0.0016	0.0008	0.035	0.024
Dresden	0.104	0.067	0.039	0.019	0.0047	0.0020	0.062	0.051
Dryden	0.072	0.040	0.019	0.0076	0.0016	0.0008	0.043	0.027
Dundalk	0.097	0.069	0.043	0.022	0.0056	0.0024	0.057	0.055
Dunnville	0.232	0.120	0.059	0.028	0.0067	0.0027	0.149	0.093
Durham	0.088	0.065	0.041	0.021	0.0053	0.0022	0.051	0.051
Dutton	0.116	0.072	0.041	0.021	0.0050	0.0021	0.071	0.056
Earlton	0.182	0.108	0.059	0.029	0.0074	0.0030	0.114	0.086
Edison	0.070	0.039	0.019	0.0075	0.0016	0.0008	0.042	0.027
Elliot Lake	0.074	0.054	0.035	0.018	0.0046	0.0020	0.043	0.043
Elmvale	0.101	0.074	0.046	0.024	0.0061	0.0025	0.059	0.059
Embro	0.111	0.072	0.042	0.022	0.0053	0.0022	0.067	0.056
Englehart	0.175	0.104	0.057	0.029	0.0073	0.0030	0.109	0.083
Espanola	0.086	0.063	0.039	0.021	0.0052	0.0021	0.050	0.050
Exeter	0.090	0.063	0.039	0.020	0.0049	0.0021	0.052	0.050
Fenelon Falls	0.121	0.086	0.052	0.027	0.0068	0.0030	0.072	0.068
Fergus	0.115	0.075	0.045	0.023	0.0056	0.0024	0.069	0.059
Forest	0.087	0.061	0.037	0.019	0.0047	0.0020	0.051	0.047
Fort Erie	0.312	0.152	0.070	0.032	0.0074	0.0028	0.202	0.117
Fort Erie (Ridgeway)	0.307	0.149	0.069	0.031	0.0073	0.0028	0.198	0.115
Fort Frances	0.064	0.035	0.017	0.0069	0.0015	0.0007	0.039	0.024
Gananoque	0.180	0.119	0.070	0.036	0.0095	0.0039	0.110	0.099
Geraldton	0.057	0.036	0.019	0.0082	0.0018	0.0010	0.033	0.024
Glencoe	0.107	0.068	0.040	0.020	0.0049	0.0021	0.064	0.054
Goderich	0.079	0.059	0.037	0.019	0.0049	0.0020	0.045	0.047
Gore Bay	0.071	0.055	0.035	0.018	0.0047	0.0020	0.040	0.044
Graham	0.071	0.039	0.020	0.0079	0.0016	0.0008	0.043	0.027
Gravenhurst (Muskoka Airport)	0.112	0.082	0.050	0.026	0.0067	0.0028	0.065	0.064
Grimsby	0.301	0.146	0.068	0.030	0.0073	0.0028	0.195	0.113
Guelph	0.133	0.082	0.047	0.024	0.0058	0.0024	0.082	0.063
Guthrie	0.109	0.078	0.048	0.025	0.0062	0.0027	0.064	0.062
Haileybury	0.219	0.127	0.067	0.033	0.0083	0.0034	0.138	0.101
Haldimand (Caledonia)	0.215	0.112	0.056	0.027	0.0064	0.0025	0.138	0.087
Haldimand (Hagersville)	0.172	0.096	0.051	0.025	0.0061	0.0024	0.108	0.074
Haliburton	0.133	0.095	0.057	0.030	0.0077	0.0032	0.079	0.076
Halton Hills (Georgetown)	0.155	0.090	0.050	0.025	0.0062	0.0025	0.097	0.070
Hamilton	0.260	0.128	0.061	0.028	0.0068	0.0027	0.168	0.101
Hanover	0.085	0.063	0.040	0.021	0.0052	0.0022	0.049	0.050
Hastings	0.141	0.096	0.057	0.029	0.0074	0.0031	0.085	0.076
Hawkesbury	0.506	0.268	0.131	0.062	0.016	0.0058	0.326	0.224

Table C-3 (Continued)

Province and Location	Seismic Data							
	S _a (0.2)	S _a (0.5)	S _a (1.0)	S _a (2.0)	S _a (5.0)	S _a (10.0)	PGA	PGV
Hearst	0.073	0.048	0.028	0.013	0.0031	0.0014	0.043	0.035
Honey Harbour	0.103	0.076	0.047	0.025	0.0062	0.0027	0.060	0.060
Hornepayne	0.063	0.043	0.025	0.012	0.0028	0.0014	0.037	0.031
Huntsville	0.129	0.091	0.054	0.028	0.0071	0.0031	0.077	0.072
Ingersoll	0.116	0.073	0.043	0.022	0.0053	0.0022	0.070	0.058
Iroquois Falls	0.196	0.101	0.052	0.025	0.0061	0.0024	0.127	0.079
Jellicoe	0.057	0.035	0.019	0.0081	0.0018	0.0010	0.033	0.024
Kapuskasing	0.112	0.064	0.035	0.017	0.0040	0.0017	0.070	0.048
Kemptville	0.429	0.229	0.114	0.054	0.014	0.0052	0.275	0.189
Kenora	0.064	0.036	0.018	0.0072	0.0015	0.0007	0.038	0.024
Killaloe	0.264	0.154	0.083	0.041	0.011	0.0044	0.168	0.127
Kincardine	0.076	0.058	0.037	0.019	0.0049	0.0021	0.043	0.046
Kingston	0.161	0.110	0.065	0.034	0.0089	0.0038	0.098	0.091
Kinmount	0.123	0.089	0.054	0.028	0.0071	0.0031	0.072	0.071
Kirkland Lake	0.159	0.095	0.053	0.027	0.0067	0.0028	0.099	0.076
Kitchener	0.122	0.077	0.045	0.023	0.0056	0.0024	0.074	0.060
Lakefield	0.130	0.091	0.055	0.028	0.0073	0.0031	0.078	0.072
Lansdowne House	0.056	0.035	0.019	0.0078	0.0016	0.0008	0.033	0.024
Leamington	0.114	0.070	0.038	0.018	0.0044	0.0018	0.069	0.052
Lindsay	0.126	0.087	0.052	0.027	0.0068	0.0030	0.076	0.068
Lion's Head	0.080	0.062	0.040	0.021	0.0052	0.0022	0.045	0.050
Listowel	0.093	0.066	0.041	0.021	0.0052	0.0022	0.054	0.052
London	0.108	0.070	0.041	0.021	0.0052	0.0021	0.064	0.055
Lucan	0.097	0.065	0.039	0.020	0.0050	0.0021	0.057	0.051
Maitland	0.282	0.167	0.090	0.045	0.012	0.0046	0.179	0.140
Markdale	0.089	0.066	0.042	0.022	0.0055	0.0022	0.052	0.052
Markham	0.182	0.103	0.056	0.028	0.0068	0.0028	0.115	0.080
Martin	0.072	0.039	0.019	0.0075	0.0015	0.0008	0.043	0.027
Matheson	0.160	0.091	0.050	0.025	0.0062	0.0025	0.101	0.072
Mattawa	0.446	0.237	0.114	0.052	0.013	0.0046	0.285	0.191
Midland	0.101	0.075	0.046	0.024	0.0061	0.0025	0.058	0.059
Milton	0.191	0.103	0.054	0.026	0.0064	0.0025	0.122	0.080
Milverton	0.098	0.067	0.041	0.021	0.0053	0.0022	0.058	0.052
Minden	0.124	0.089	0.054	0.028	0.0071	0.0031	0.073	0.071
Mississauga	0.219	0.115	0.058	0.028	0.0068	0.0027	0.141	0.090
Mississauga (Lester B. Pearson Int'l Airport)	0.193	0.105	0.056	0.027	0.0067	0.0027	0.123	0.082
Mississauga (Port Credit)	0.247	0.125	0.062	0.029	0.0070	0.0027	0.159	0.098
Mitchell	0.093	0.065	0.040	0.021	0.0052	0.0021	0.054	0.051
Moosonee	0.081	0.051	0.029	0.014	0.0033	0.0015	0.049	0.038
Morrisburg	0.558	0.287	0.135	0.062	0.016	0.0056	0.358	0.236
Mount Forest	0.093	0.067	0.041	0.022	0.0053	0.0022	0.054	0.052
Nakina	0.057	0.036	0.019	0.0082	0.0018	0.0010	0.033	0.024
Nanticoke (Jarvis)	0.156	0.090	0.049	0.024	0.0059	0.0024	0.098	0.068

Table C-3 (Continued)

Province and Location	Seismic Data							
	S _a (0.2)	S _a (0.5)	S _a (1.0)	S _a (2.0)	S _a (5.0)	S _a (10.0)	PGA	PGV
Nanticoke (Port Dover)	0.144	0.085	0.047	0.023	0.0058	0.0024	0.089	0.066
Napanee	0.156	0.106	0.063	0.033	0.0084	0.0037	0.095	0.087
New Liskeard	0.209	0.122	0.065	0.032	0.0081	0.0032	0.132	0.097
Newcastle	0.186	0.107	0.058	0.029	0.0071	0.0030	0.118	0.086
Newcastle (Bowmanville)	0.188	0.107	0.058	0.029	0.0071	0.0030	0.119	0.086
Newmarket	0.132	0.085	0.050	0.026	0.0064	0.0027	0.081	0.067
Niagara Falls	0.321	0.157	0.072	0.032	0.0076	0.0030	0.207	0.121
North Bay	0.247	0.145	0.076	0.037	0.0095	0.0037	0.155	0.114
Norwood	0.136	0.094	0.057	0.029	0.0074	0.0031	0.082	0.075
Oakville	0.260	0.129	0.062	0.029	0.0070	0.0027	0.167	0.101
Orangeville	0.115	0.076	0.046	0.023	0.0058	0.0024	0.069	0.059
Orillia	0.109	0.079	0.049	0.026	0.0064	0.0027	0.064	0.063
Oshawa	0.192	0.108	0.058	0.029	0.0071	0.0030	0.122	0.086
Ottawa (Metropolitan)								
Ottawa (City Hall)	0.439	0.237	0.118	0.056	0.015	0.0055	0.281	0.196
Ottawa (Barrhaven)	0.427	0.230	0.115	0.055	0.015	0.0053	0.273	0.191
Ottawa (Kanata)	0.401	0.218	0.110	0.053	0.014	0.0052	0.257	0.181
Ottawa (M-C Int'l Airport)	0.446	0.240	0.119	0.056	0.015	0.0055	0.285	0.199
Ottawa (Orleans)	0.474	0.252	0.124	0.058	0.015	0.0056	0.304	0.208
Owen Sound	0.083	0.064	0.041	0.021	0.0053	0.0022	0.048	0.051
Pagwa River	0.060	0.040	0.023	0.011	0.0024	0.0013	0.035	0.028
Paris	0.141	0.084	0.047	0.023	0.0058	0.0024	0.088	0.066
Parkhill	0.092	0.063	0.038	0.020	0.0049	0.0020	0.054	0.050
Parry Sound	0.110	0.079	0.048	0.025	0.0064	0.0027	0.064	0.063
Pelham (Fonthill)	0.311	0.152	0.070	0.031	0.0074	0.0028	0.201	0.117
Pembroke	0.379	0.203	0.101	0.049	0.013	0.0048	0.243	0.168
Penetanguishene	0.101	0.074	0.046	0.024	0.0061	0.0025	0.058	0.059
Perth	0.225	0.142	0.080	0.041	0.011	0.0045	0.140	0.119
Petawawa	0.379	0.202	0.101	0.048	0.013	0.0048	0.243	0.166
Peterborough	0.135	0.092	0.055	0.028	0.0071	0.0031	0.082	0.072
Petrolia	0.092	0.062	0.037	0.019	0.0047	0.0020	0.054	0.048
Pickering (Dunbarton)	0.219	0.117	0.060	0.029	0.0071	0.0028	0.140	0.094
Picton	0.159	0.104	0.061	0.031	0.0078	0.0032	0.098	0.086
Plattsville	0.119	0.075	0.044	0.022	0.0055	0.0022	0.072	0.059
Point Alexander	0.391	0.209	0.104	0.049	0.013	0.0048	0.251	0.172
Port Burwell	0.132	0.079	0.044	0.022	0.0055	0.0022	0.081	0.062
Port Colborne	0.298	0.146	0.068	0.031	0.0073	0.0028	0.192	0.113
Port Elgin	0.077	0.060	0.038	0.020	0.0050	0.0021	0.044	0.048
Port Hope	0.181	0.106	0.059	0.029	0.0073	0.0030	0.114	0.086
Port Perry	0.144	0.091	0.053	0.027	0.0067	0.0028	0.089	0.071
Port Stanley	0.123	0.075	0.043	0.021	0.0052	0.0021	0.075	0.058
Prescott	0.350	0.195	0.101	0.049	0.013	0.0049	0.224	0.162

Table C-3 (Continued)

Province and Location	Seismic Data							
	S _a (0.2)	S _a (0.5)	S _a (1.0)	S _a (2.0)	S _a (5.0)	S _a (10.0)	PGA	PGV
Princeton	0.129	0.079	0.045	0.023	0.0056	0.0022	0.079	0.062
Raith	0.067	0.038	0.019	0.0078	0.0016	0.0008	0.040	0.025
Rayside-Balfour (Chelmsford)	0.104	0.072	0.044	0.023	0.0058	0.0024	0.061	0.056
Red Lake	0.068	0.038	0.019	0.0076	0.0016	0.0008	0.041	0.025
Renfrew	0.352	0.191	0.097	0.047	0.013	0.0048	0.226	0.160
Richmond Hill	0.163	0.095	0.053	0.027	0.0065	0.0027	0.102	0.074
Rockland	0.510	0.266	0.129	0.060	0.016	0.0056	0.328	0.221
Sarnia	0.085	0.059	0.036	0.018	0.0046	0.0020	0.049	0.046
Sault Ste. Marie	0.062	0.044	0.028	0.014	0.0033	0.0015	0.036	0.034
Schreiber	0.057	0.035	0.019	0.0079	0.0018	0.0010	0.033	0.024
Seaforth	0.087	0.062	0.039	0.020	0.0050	0.0021	0.050	0.048
Shelburne	0.104	0.072	0.044	0.023	0.0058	0.0024	0.062	0.056
Simcoe	0.141	0.084	0.047	0.023	0.0058	0.0024	0.087	0.064
Sioux Lookout	0.073	0.040	0.020	0.0078	0.0016	0.0008	0.044	0.028
Smiths Falls	0.256	0.156	0.086	0.044	0.012	0.0046	0.161	0.131
Smithville	0.296	0.144	0.067	0.030	0.0071	0.0027	0.191	0.111
Smooth Rock Falls	0.200	0.098	0.047	0.021	0.0050	0.0020	0.130	0.074
South River	0.164	0.106	0.061	0.031	0.0080	0.0034	0.100	0.085
Southampton	0.077	0.060	0.038	0.020	0.0050	0.0021	0.044	0.048
St. Catharines	0.319	0.155	0.071	0.032	0.0076	0.0028	0.206	0.121
St. Mary's	0.101	0.068	0.041	0.021	0.0052	0.0021	0.060	0.052
St. Thomas	0.117	0.073	0.042	0.021	0.0052	0.0021	0.071	0.056
Stirling	0.149	0.100	0.060	0.031	0.0078	0.0034	0.091	0.082
Stratford	0.103	0.069	0.041	0.021	0.0053	0.0022	0.061	0.054
Strathroy	0.100	0.066	0.039	0.020	0.0049	0.0021	0.059	0.051
Sturgeon Falls	0.183	0.113	0.062	0.031	0.0080	0.0032	0.113	0.089
Sudbury	0.110	0.076	0.046	0.024	0.0059	0.0025	0.065	0.059
Sundridge	0.157	0.103	0.059	0.030	0.0078	0.0032	0.095	0.082
Tavistock	0.108	0.071	0.042	0.022	0.0053	0.0022	0.065	0.055
Temagami	0.239	0.138	0.072	0.035	0.0089	0.0035	0.151	0.109
Thamesford	0.111	0.071	0.042	0.021	0.0053	0.0022	0.066	0.056
Theford	0.089	0.062	0.038	0.019	0.0047	0.0020	0.052	0.048
Thunder Bay	0.061	0.035	0.018	0.0075	0.0016	0.0008	0.036	0.024
Tillsonburg	0.126	0.077	0.044	0.022	0.0055	0.0022	0.076	0.060
Timmins	0.125	0.075	0.043	0.021	0.0053	0.0022	0.078	0.058
Timmins (Porcupine)	0.140	0.081	0.045	0.022	0.0055	0.0022	0.088	0.063
Toronto Metropolitan Region								
Etobicoke	0.193	0.106	0.056	0.027	0.0067	0.0027	0.124	0.082
North York	0.195	0.107	0.056	0.028	0.0067	0.0027	0.125	0.083
Scarborough	0.219	0.116	0.060	0.029	0.0070	0.0028	0.140	0.093
Toronto (City Hall)	0.249	0.126	0.063	0.029	0.0071	0.0028	0.160	0.099
Trenton	0.167	0.105	0.060	0.030	0.0077	0.0032	0.104	0.086

Table C-3 (Continued)

Province and Location	Seismic Data							
	S _a (0.2)	S _a (0.5)	S _a (1.0)	S _a (2.0)	S _a (5.0)	S _a (10.0)	PGA	PGV
Trout Creek	0.186	0.116	0.065	0.033	0.0084	0.0035	0.115	0.093
Uxbridge	0.139	0.089	0.052	0.027	0.0067	0.0028	0.086	0.070
Vaughan (Woodbridge)	0.167	0.096	0.053	0.026	0.0065	0.0027	0.105	0.074
Vittoria	0.139	0.083	0.046	0.023	0.0056	0.0024	0.086	0.064
Walkerton	0.083	0.062	0.039	0.021	0.0052	0.0021	0.048	0.050
Wallaceburg	0.098	0.064	0.037	0.018	0.0044	0.0018	0.058	0.048
Waterloo	0.118	0.075	0.044	0.023	0.0056	0.0022	0.072	0.059
Watford	0.095	0.064	0.038	0.019	0.0049	0.0020	0.056	0.050
Wawa	0.062	0.043	0.026	0.013	0.0030	0.0014	0.036	0.031
Welland	0.308	0.150	0.069	0.031	0.0074	0.0028	0.199	0.115
West Lorne	0.118	0.072	0.041	0.021	0.0050	0.0021	0.072	0.056
Whitby	0.203	0.112	0.059	0.029	0.0071	0.0028	0.130	0.089
Whitby (Brooklin)	0.176	0.102	0.056	0.028	0.0070	0.0028	0.111	0.080
White River	0.060	0.041	0.024	0.011	0.0025	0.0013	0.035	0.030
Warton	0.080	0.062	0.040	0.021	0.0052	0.0022	0.046	0.050
Windsor	0.096	0.063	0.035	0.017	0.0041	0.0017	0.057	0.048
Wingham	0.083	0.061	0.039	0.020	0.0050	0.0021	0.048	0.048
Woodstock	0.118	0.075	0.043	0.022	0.0055	0.0022	0.071	0.058
Wyoming	0.090	0.061	0.037	0.019	0.0047	0.0020	0.053	0.048
Quebec								
Acton-Vale	0.254	0.160	0.091	0.047	0.013	0.0051	0.159	0.138
Alma	0.785	0.416	0.196	0.089	0.022	0.0075	0.486	0.339
Amos	0.109	0.078	0.049	0.026	0.0067	0.0028	0.064	0.063
Asbestos	0.200	0.137	0.082	0.043	0.012	0.0049	0.123	0.118
Aylmer	0.415	0.225	0.113	0.054	0.014	0.0053	0.265	0.186
Baie-Comeau	0.425	0.219	0.107	0.051	0.013	0.0051	0.275	0.182
Baie-Saint-Paul	1.62	0.872	0.406	0.179	0.043	0.012	0.986	0.735
Beauport	0.509	0.275	0.138	0.067	0.018	0.0065	0.327	0.233
Bedford	0.358	0.204	0.107	0.053	0.014	0.0053	0.228	0.170
Beloil	0.522	0.272	0.131	0.062	0.016	0.0059	0.333	0.225
Brome	0.236	0.152	0.087	0.045	0.012	0.0049	0.147	0.130
Brossard	0.587	0.306	0.145	0.067	0.017	0.0062	0.374	0.251
Buckingham	0.491	0.257	0.125	0.058	0.015	0.0056	0.316	0.213
Campbell's Bay	0.387	0.208	0.105	0.050	0.013	0.0051	0.248	0.173
Chambly	0.550	0.286	0.137	0.064	0.017	0.0059	0.352	0.236
Coaticook	0.193	0.129	0.077	0.040	0.011	0.0045	0.119	0.110
Contrecoeur	0.473	0.251	0.124	0.059	0.016	0.0058	0.303	0.207
Cowansville	0.273	0.168	0.094	0.048	0.013	0.0051	0.172	0.142
Deux-Montagnes	0.596	0.313	0.149	0.069	0.018	0.0062	0.380	0.258
Dolbeau	0.484	0.255	0.125	0.058	0.015	0.0055	0.308	0.211
Drummondville	0.273	0.167	0.094	0.048	0.013	0.0052	0.172	0.144
Farnham	0.369	0.208	0.109	0.054	0.015	0.0055	0.235	0.174

Table C-3 (Continued)

Province and Location	Seismic Data							
	S _a (0.2)	S _a (0.5)	S _a (1.0)	S _a (2.0)	S _a (5.0)	S _a (10.0)	PGA	PGV
Fort-Coulonge	0.391	0.210	0.105	0.050	0.013	0.0051	0.251	0.174
Gagnon	0.078	0.060	0.040	0.021	0.0055	0.0022	0.045	0.048
Gaspé	0.128	0.090	0.056	0.029	0.0077	0.0032	0.076	0.074
Gatineau	0.442	0.238	0.119	0.056	0.015	0.0055	0.283	0.197
Gracefield	0.426	0.222	0.109	0.051	0.013	0.0051	0.278	0.185
Granby	0.275	0.169	0.094	0.048	0.013	0.0052	0.173	0.144
Harrington-Harbour	0.072	0.056	0.037	0.020	0.0052	0.0022	0.041	0.046
Havre-St-Pierre	0.231	0.122	0.062	0.030	0.0077	0.0031	0.148	0.097
Hemmingford	0.546	0.290	0.141	0.066	0.017	0.0060	0.347	0.239
Hull	0.432	0.234	0.117	0.056	0.015	0.0055	0.276	0.195
Iberville	0.520	0.273	0.132	0.062	0.016	0.0059	0.332	0.225
Inukjuak	0.065	0.040	0.022	0.0094	0.0021	0.0010	0.038	0.028
Joliette	0.457	0.241	0.119	0.057	0.015	0.0056	0.293	0.201
Kuujuuaq	0.074	0.054	0.036	0.019	0.0049	0.0021	0.043	0.043
Kuujuarapik	0.056	0.035	0.019	0.0078	0.0016	0.0008	0.032	0.024
La Pocatière	1.51	0.817	0.384	0.170	0.041	0.012	0.927	0.690
La-Malbaie	1.73	0.954	0.454	0.203	0.049	0.014	1.04	0.809
La-Tuque	0.196	0.137	0.082	0.043	0.012	0.0049	0.120	0.119
Lac-Mégantic	0.193	0.130	0.077	0.040	0.011	0.0045	0.119	0.111
Lachute	0.518	0.274	0.133	0.063	0.016	0.0059	0.333	0.228
Lennoxville	0.187	0.129	0.077	0.041	0.011	0.0046	0.114	0.110
Léry	0.603	0.318	0.152	0.070	0.018	0.0063	0.384	0.262
Loretteville	0.502	0.268	0.134	0.065	0.017	0.0063	0.323	0.227
Louiseville	0.366	0.201	0.105	0.052	0.014	0.0055	0.234	0.170
Magog	0.196	0.133	0.079	0.042	0.011	0.0046	0.120	0.114
Malartic	0.135	0.092	0.055	0.029	0.0074	0.0031	0.081	0.074
Maniwaki	0.430	0.220	0.107	0.050	0.013	0.0049	0.282	0.184
Masson	0.498	0.261	0.127	0.059	0.016	0.0056	0.320	0.216
Matane	0.455	0.230	0.110	0.052	0.013	0.0051	0.295	0.191
Mont-Joli	0.427	0.226	0.113	0.055	0.015	0.0055	0.275	0.191
Mont-Laurier	0.419	0.212	0.103	0.049	0.013	0.0048	0.276	0.177
Montmagny	0.601	0.341	0.172	0.082	0.022	0.0075	0.382	0.286
Montréal Region Beaconsfield	0.602	0.317	0.152	0.070	0.018	0.0063	0.383	0.260
Dorval	0.600	0.316	0.151	0.069	0.018	0.0062	0.382	0.259
Laval	0.595	0.311	0.148	0.068	0.018	0.0062	0.379	0.256
Montréal (City Hall)	0.595	0.311	0.148	0.068	0.018	0.0062	0.379	0.255
Montréal-Est	0.586	0.305	0.145	0.067	0.017	0.0062	0.374	0.250
Montréal-Nord	0.593	0.309	0.147	0.068	0.017	0.0062	0.378	0.254
Outremont	0.597	0.313	0.149	0.068	0.018	0.0062	0.380	0.256
Pierrefonds	0.599	0.315	0.151	0.069	0.018	0.0062	0.382	0.259
St-Lambert	0.590	0.307	0.146	0.067	0.017	0.0062	0.376	0.252

Table C-3 (Continued)

Province and Location	Seismic Data							
	S _a (0.2)	S _a (0.5)	S _a (1.0)	S _a (2.0)	S _a (5.0)	S _a (10.0)	PGA	PGV
St-Laurent	0.598	0.314	0.149	0.069	0.018	0.0062	0.381	0.258
Ste-Anne-de-Bellevue	0.602	0.317	0.152	0.070	0.018	0.0063	0.383	0.262
Verdun	0.596	0.312	0.149	0.068	0.018	0.0062	0.380	0.256
Nicolet (Gentilly)	0.364	0.201	0.106	0.052	0.015	0.0055	0.233	0.170
Nitchequon	0.062	0.047	0.031	0.017	0.0041	0.0018	0.035	0.038
Noranda	0.132	0.088	0.052	0.027	0.0068	0.0028	0.080	0.070
Percé	0.114	0.084	0.053	0.029	0.0074	0.0032	0.067	0.068
Pincourt	0.602	0.318	0.152	0.070	0.018	0.0063	0.384	0.262
Plessisville	0.250	0.160	0.092	0.048	0.013	0.0052	0.157	0.140
Port-Cartier	0.323	0.169	0.084	0.040	0.010	0.0039	0.210	0.137
Puvirnituq	0.108	0.058	0.029	0.012	0.0025	0.0011	0.068	0.043
Québec City Region								
Ancienne-Lorette	0.487	0.258	0.130	0.062	0.017	0.0062	0.314	0.220
Lévis	0.493	0.265	0.134	0.065	0.017	0.0063	0.317	0.225
Québec	0.493	0.265	0.133	0.064	0.017	0.0063	0.318	0.225
Sillery	0.486	0.260	0.131	0.063	0.017	0.0062	0.313	0.221
Ste-Foy	0.488	0.261	0.131	0.063	0.017	0.0062	0.315	0.221
Richmond	0.208	0.140	0.083	0.044	0.012	0.0049	0.128	0.121
Rimouski	0.408	0.224	0.116	0.056	0.015	0.0056	0.262	0.192
Rivière-du-Loup	1.16	0.616	0.288	0.129	0.032	0.0097	0.724	0.517
Roberval	0.688	0.353	0.164	0.074	0.019	0.0065	0.430	0.287
Rock-Island	0.199	0.133	0.078	0.041	0.011	0.0046	0.123	0.113
Rosemère	0.591	0.309	0.147	0.068	0.017	0.0062	0.377	0.255
Rouyn	0.134	0.089	0.052	0.027	0.0068	0.0028	0.081	0.070
Saguenay	0.791	0.425	0.204	0.095	0.024	0.0080	0.491	0.353
Saguenay (Bagotville)	0.801	0.434	0.210	0.098	0.025	0.0083	0.498	0.362
Saguenay (Jonquière)	0.798	0.428	0.206	0.095	0.024	0.0080	0.495	0.354
Saguenay (Kenogami)	0.799	0.428	0.206	0.095	0.024	0.0080	0.496	0.354
Saint-Eustache	0.593	0.311	0.149	0.068	0.018	0.0062	0.378	0.256
Saint-Jean-sur-Richelieu	0.522	0.274	0.133	0.062	0.016	0.0059	0.333	0.227
Salaberry-de-Valleyfield	0.602	0.318	0.152	0.070	0.018	0.0063	0.384	0.262
Schefferville	0.059	0.042	0.027	0.014	0.0033	0.0015	0.034	0.031
Senneterre	0.114	0.083	0.052	0.028	0.0071	0.0031	0.067	0.067
Sept-Îles	0.295	0.156	0.078	0.037	0.0095	0.0038	0.191	0.126
Shawinigan	0.306	0.179	0.098	0.049	0.014	0.0053	0.195	0.154
Shawville	0.386	0.208	0.105	0.050	0.013	0.0051	0.248	0.173
Sherbrooke	0.187	0.129	0.078	0.041	0.011	0.0046	0.115	0.111
Sorel	0.406	0.220	0.113	0.055	0.015	0.0056	0.259	0.184
St-Félicien	0.488	0.259	0.127	0.059	0.016	0.0056	0.309	0.212
St-Georges-de-Cacouna	0.857	0.478	0.234	0.109	0.028	0.0090	0.533	0.396
St-Hubert	0.581	0.302	0.144	0.066	0.017	0.0060	0.371	0.248
Saint-Hubert-de-Rivière-du-Loup	0.468	0.279	0.147	0.073	0.020	0.0069	0.298	0.237

Table C-3 (Continued)

Province and Location	Seismic Data							
	S _a (0.2)	S _a (0.5)	S _a (1.0)	S _a (2.0)	S _a (5.0)	S _a (10.0)	PGA	PGV
St-Hyacinthe	0.369	0.208	0.109	0.054	0.015	0.0055	0.235	0.174
St-Jérôme	0.539	0.282	0.135	0.063	0.017	0.0059	0.346	0.233
St-Jovite	0.428	0.222	0.110	0.052	0.014	0.0052	0.281	0.186
St-Lazare-Hudson	0.597	0.315	0.151	0.070	0.018	0.0062	0.380	0.259
St-Nicolas	0.466	0.248	0.125	0.060	0.016	0.0060	0.301	0.211
Ste-Agathe-des-Monts	0.431	0.226	0.112	0.054	0.014	0.0053	0.282	0.191
Sutton	0.243	0.154	0.088	0.045	0.012	0.0049	0.152	0.131
Tadoussac	0.694	0.399	0.202	0.097	0.026	0.0084	0.434	0.335
Témiscaming	0.820	0.411	0.181	0.075	0.017	0.0053	0.516	0.329
Terrebonne	0.584	0.304	0.144	0.067	0.017	0.0060	0.373	0.250
Thetford Mines	0.207	0.142	0.084	0.044	0.012	0.0049	0.127	0.123
Thurso	0.492	0.258	0.126	0.059	0.016	0.0056	0.318	0.215
Trois-Rivières	0.366	0.200	0.105	0.052	0.014	0.0055	0.234	0.170
Val-d'Or	0.135	0.093	0.056	0.029	0.0076	0.0032	0.081	0.074
Varenes	0.571	0.296	0.141	0.065	0.017	0.0060	0.365	0.243
Verchères	0.537	0.278	0.134	0.062	0.016	0.0059	0.343	0.229
Victoriaville	0.233	0.152	0.089	0.046	0.013	0.0051	0.145	0.133
Ville-Marie	0.262	0.148	0.076	0.037	0.0093	0.0037	0.166	0.117
Wakefield	0.409	0.222	0.111	0.054	0.014	0.0053	0.262	0.185
Waterloo	0.232	0.150	0.087	0.045	0.012	0.0049	0.144	0.129
Windsor	0.194	0.134	0.080	0.042	0.012	0.0048	0.119	0.115
New Brunswick								
Alma	0.144	0.096	0.058	0.030	0.0078	0.0034	0.088	0.079
Bathurst	0.217	0.127	0.071	0.036	0.0090	0.0038	0.138	0.105
Campbellton	0.210	0.133	0.076	0.039	0.010	0.0042	0.132	0.113
Edmundston	0.231	0.153	0.089	0.046	0.012	0.0049	0.145	0.134
Fredericton	0.210	0.127	0.071	0.037	0.0093	0.0039	0.133	0.105
Gagetown	0.195	0.119	0.068	0.035	0.0089	0.0038	0.122	0.098
Grand Falls	0.254	0.153	0.085	0.043	0.011	0.0046	0.162	0.131
Miramichi	0.214	0.125	0.069	0.035	0.0087	0.0037	0.136	0.102
Moncton	0.158	0.100	0.059	0.031	0.0078	0.0034	0.098	0.083
Oromocto	0.209	0.126	0.071	0.036	0.0092	0.0039	0.132	0.103
Sackville	0.140	0.093	0.057	0.030	0.0078	0.0034	0.085	0.079
Saint Andrews	0.874	0.436	0.189	0.077	0.017	0.0053	0.544	0.345
Saint George	0.578	0.298	0.135	0.058	0.014	0.0048	0.367	0.232
Saint John	0.199	0.121	0.068	0.035	0.0089	0.0037	0.125	0.097
Shippagan	0.143	0.096	0.058	0.030	0.0078	0.0034	0.087	0.079
St. Stephen	0.781	0.380	0.163	0.067	0.015	0.0051	0.491	0.302
Woodstock	0.206	0.129	0.074	0.038	0.0099	0.0042	0.130	0.109
Nova Scotia								
Amherst	0.130	0.089	0.055	0.030	0.0078	0.0034	0.078	0.074
Antigonish	0.098	0.076	0.050	0.028	0.0073	0.0031	0.057	0.064

Table C-3 (Continued)

Province and Location	Seismic Data							
	S _a (0.2)	S _a (0.5)	S _a (1.0)	S _a (2.0)	S _a (5.0)	S _a (10.0)	PGA	PGV
Bridgewater	0.117	0.086	0.054	0.029	0.0078	0.0034	0.068	0.071
Canso	0.114	0.085	0.054	0.029	0.0078	0.0034	0.066	0.071
Debert	0.107	0.080	0.052	0.029	0.0076	0.0032	0.062	0.068
Digby	0.164	0.105	0.061	0.032	0.0083	0.0035	0.101	0.085
Greenwood (CFB)	0.128	0.090	0.055	0.029	0.0077	0.0032	0.076	0.074
Halifax Region								
Dartmouth	0.110	0.082	0.053	0.029	0.0076	0.0032	0.064	0.068
Halifax	0.110	0.082	0.053	0.029	0.0076	0.0032	0.064	0.068
Kentville	0.120	0.087	0.055	0.030	0.0078	0.0034	0.071	0.072
Liverpool	0.120	0.086	0.054	0.029	0.0076	0.0032	0.070	0.070
Lockeport	0.123	0.087	0.054	0.028	0.0074	0.0031	0.073	0.071
Louisburg	0.119	0.089	0.056	0.030	0.0080	0.0035	0.069	0.074
Lunenburg	0.115	0.085	0.054	0.029	0.0078	0.0034	0.067	0.070
New Glasgow	0.099	0.077	0.051	0.028	0.0074	0.0032	0.057	0.064
North Sydney	0.105	0.081	0.053	0.029	0.0076	0.0032	0.061	0.068
Pictou	0.098	0.076	0.050	0.028	0.0074	0.0031	0.057	0.064
Port Hawkesbury	0.102	0.079	0.052	0.028	0.0076	0.0032	0.059	0.066
Springhill	0.118	0.085	0.054	0.029	0.0077	0.0034	0.070	0.071
Stewiacke	0.107	0.081	0.053	0.029	0.0077	0.0032	0.062	0.068
Sydney	0.108	0.083	0.054	0.029	0.0077	0.0034	0.063	0.070
Tatamagouche	0.103	0.079	0.052	0.028	0.0076	0.0032	0.061	0.066
Truro	0.105	0.080	0.052	0.029	0.0076	0.0032	0.061	0.067
Wolfville	0.118	0.086	0.055	0.030	0.0078	0.0034	0.069	0.071
Yarmouth	0.137	0.094	0.057	0.030	0.0078	0.0034	0.082	0.075
Prince Edward Island								
Charlottetown	0.103	0.077	0.051	0.028	0.0074	0.0032	0.060	0.066
Souris	0.091	0.073	0.049	0.027	0.0071	0.0031	0.052	0.062
Summerside	0.133	0.089	0.055	0.029	0.0076	0.0032	0.082	0.075
Tignish	0.135	0.090	0.056	0.030	0.0076	0.0032	0.083	0.076
Newfoundland								
Argentia	0.098	0.079	0.052	0.029	0.0076	0.0032	0.056	0.066
Bonavista	0.083	0.067	0.045	0.025	0.0065	0.0028	0.047	0.056
Buchans	0.077	0.064	0.044	0.024	0.0064	0.0028	0.043	0.054
Cape Harrison	0.125	0.087	0.052	0.028	0.0071	0.0031	0.074	0.068
Cape Race	0.108	0.085	0.055	0.030	0.0080	0.0034	0.062	0.071
Channel-Port aux Basques	0.088	0.071	0.048	0.026	0.0068	0.0030	0.050	0.059
Corner Brook	0.074	0.062	0.043	0.024	0.0062	0.0027	0.042	0.052
Gander	0.077	0.064	0.044	0.024	0.0064	0.0027	0.044	0.054
Grand Bank	0.115	0.090	0.057	0.031	0.0081	0.0035	0.067	0.074
Grand Falls	0.076	0.064	0.044	0.024	0.0064	0.0027	0.043	0.054
Happy Valley-Goose Bay	0.067	0.050	0.032	0.017	0.0044	0.0018	0.039	0.040
Labrador City	0.067	0.052	0.035	0.019	0.0047	0.0020	0.038	0.042

Table C-3 (Continued)

Province and Location	Seismic Data							
	S _a (0.2)	S _a (0.5)	S _a (1.0)	S _a (2.0)	S _a (5.0)	S _a (10.0)	PGA	PGV
St. Anthony	0.073	0.057	0.038	0.021	0.0053	0.0022	0.041	0.047
St. John's	0.090	0.073	0.049	0.027	0.0071	0.0031	0.052	0.062
Stephenville	0.077	0.064	0.044	0.025	0.0064	0.0028	0.044	0.054
Twin Falls	0.064	0.047	0.030	0.016	0.0040	0.0017	0.037	0.036
Wabana	0.089	0.072	0.048	0.027	0.0071	0.0031	0.051	0.060
Wabush	0.067	0.052	0.035	0.019	0.0047	0.0020	0.039	0.042
Yukon								
Aishihik	0.446	0.364	0.233	0.122	0.043	0.016	0.218	0.255
Dawson	0.396	0.277	0.168	0.087	0.030	0.012	0.185	0.174
Destruction Bay ⁽¹⁾	1.54	1.15	0.666	0.330	0.119	0.038	0.693	0.816
Faro	0.271	0.189	0.122	0.067	0.023	0.0091	0.126	0.125
Haines Junction	0.973	0.691	0.398	0.193	0.066	0.022	0.467	0.452
Snag	0.502	0.394	0.254	0.138	0.052	0.019	0.242	0.294
Teslin	0.284	0.202	0.129	0.073	0.025	0.0096	0.133	0.138
Watson Lake	0.304	0.214	0.125	0.061	0.020	0.0077	0.142	0.123
Whitehorse	0.334	0.258	0.170	0.094	0.033	0.012	0.154	0.184
Northwest Territories								
Aklavik	0.475	0.321	0.183	0.089	0.029	0.011	0.225	0.199
Echo Bay / Port Radium	0.052	0.038	0.031	0.020	0.0068	0.0031	0.030	0.032
Fort Good Hope	0.257	0.197	0.128	0.068	0.024	0.0091	0.119	0.127
Fort McPherson	0.476	0.354	0.211	0.103	0.035	0.013	0.225	0.223
Fort Providence	0.055	0.044	0.037	0.023	0.0077	0.0035	0.031	0.038
Fort Resolution	0.052	0.032	0.017	0.0072	0.0015	0.0008	0.030	0.021
Fort Simpson	0.154	0.134	0.090	0.047	0.016	0.0062	0.072	0.083
Fort Smith	0.052	0.031	0.016	0.0065	0.0013	0.0007	0.030	0.021
Hay River	0.053	0.034	0.025	0.016	0.0056	0.0025	0.031	0.028
Holman/Ulukhaqtuuq	0.057	0.040	0.025	0.012	0.0031	0.0014	0.033	0.030
Inuvik	0.308	0.223	0.139	0.072	0.025	0.0094	0.145	0.149
Mould Bay	0.21	0.120	0.070	0.037	0.010	0.0041	0.136	0.104
Norman Wells	0.688	0.445	0.238	0.105	0.031	0.011	0.340	0.256
Rae-Edzo	0.052	0.036	0.029	0.019	0.0065	0.0030	0.030	0.031
Tungsten	0.325	0.238	0.143	0.070	0.023	0.0089	0.153	0.145
Wrigley	0.653	0.421	0.224	0.099	0.029	0.010	0.319	0.241
Yellowknife	0.052	0.032	0.017	0.0070	0.0015	0.0008	0.030	0.021
Nunavut								
Alert	0.145	0.083	0.044	0.021	0.0049	0.0020	0.091	0.062
Arctic Bay	0.111	0.080	0.052	0.028	0.0071	0.0031	0.066	0.066
Arviat / Eskimo Point	0.054	0.037	0.022	0.0097	0.0021	0.0011	0.031	0.025
Baker Lake	0.068	0.048	0.029	0.014	0.0031	0.0014	0.039	0.035
Cambridge Bay/Iqaluktuuttiaq	0.059	0.041	0.025	0.012	0.0025	0.0013	0.034	0.030
Chesterfield Inlet/Igluligaarjuk	0.081	0.054	0.031	0.015	0.0034	0.0015	0.047	0.042
Clyde River /Kangiqtuqaapik	0.306	0.186	0.104	0.053	0.015	0.0056	0.195	0.162

Table C-3 (Continued)

Province and Location	Seismic Data							
	S _a (0.2)	S _a (0.5)	S _a (1.0)	S _a (2.0)	S _a (5.0)	S _a (10.0)	PGA	PGV
Coppermine (Kugluktuk)	0.053	0.031	0.016	0.0066	0.0013	0.0007	0.031	0.021
Coral Harbour /Salliq	0.103	0.064	0.035	0.016	0.0037	0.0015	0.062	0.048
Eureka	0.173	0.106	0.065	0.035	0.010	0.0040	0.110	0.093
Iqaluit	0.087	0.065	0.043	0.023	0.0058	0.0025	0.051	0.052
Isachsen	0.256	0.171	0.102	0.055	0.016	0.0061	0.162	0.158
Nottingham Island	0.109	0.060	0.031	0.014	0.0030	0.0014	0.068	0.044
Rankin Inlet (Kangiiniq)	0.064	0.045	0.027	0.013	0.0028	0.0014	0.036	0.034
Resolute	0.194	0.105	0.057	0.028	0.0069	0.0030	0.124	0.084
Resolution Island	0.203	0.123	0.069	0.035	0.0092	0.0038	0.128	0.102

National Building Code of Canada 2015 Volume 1, Division B

ICFMA

INSULATING CONCRETE FORMS
MANUFACTURERS ASSOCIATION
ICF-MA.ORG

The Insulating Concrete Forms Manufacturers Association Prescriptive ICF Design for Part 9 Structures in Canada

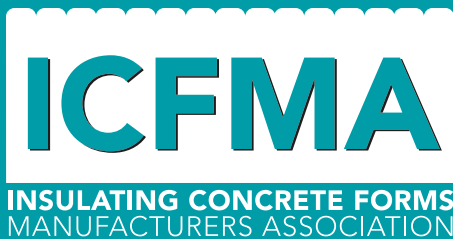

THE INSULATING CONCRETE FORMS MANUFACTURERS ASSOCIATION

The Insulating Concrete Forms Manufacturers Association (ICFMA) is the North American non-profit trade association for the Insulated Concrete Form industry and was founded in 2014 by a dedicated group of manufacturers with the interest of improving the quality and acceptance of Insulated Concrete Form construction.

MISSION

The mission of the ICFMA is to promote and enhance the social, environmental and economic value of insulating concrete forms in the North American marketplace.

LEARN MORE ABOUT ICFS AT ICF-MA.ORG