

NatureKast Collective

NatureKast's Collective offers a series of dynamic outdoor kitchen configurations.



How do you use this document?

Choose an outdoor kitchen layout from this series *or* use it as a springboard to design something different! Each layout includes a preloaded quote that can be modified to your preferences.

To copy a quote to your DealerNet profile:

- ▶ **Click** Create Quote
- ▶ **Select** the NatureKast Collective layout (A to P) that you would like copied from the "Is this a NK Collective Quote?" menu
- ▶ **Delete** the rooms you don't need. The quote has three Rooms with the different preloaded Door Styles and Finishes:
 - Shaker, Weathered Graphite
 - Metro Lite, Pelee Island Pearl
 - Contempo Stainless Steel, Weathered Graphite
- ▶ **Change** the Door Style or Finish if required

NatureKast Collective...

A. 6' Grill Run



B. 6' Ceramic Grill Run



C. 7' Grill Run



D. 7' Grill Run with Uppers



E. 8' Grill & Side Burner Run



F. 8' x 8' L-shaped Sink & Cooktop Island



G. 9' x 8' L-shaped Sink & Grill Run



H. 10' Galley Sink Island



I. 10' Cooktop & Sink Run



J. 10' Grill & Cooktop Run



K. 10' Grill & Sink Island



L. 10' Sink Run



M. 10' x 9' L-shaped Grill & Sink Run with Raised Bar



N. 12' Grill & Ceramic Grill Island



O. 12' Grill & Sink Run with Hood & Uppers



P. 14' Pizza Oven, Grill & Burner Run



A. 6' Grill Run



NatureKast Weatherproof Cabinetry
570 Welland Ave, Unit 5
St. Catharines, ON L2M 5V6
Tel: 1.844.880.6314

DEALER

PROJECT

QUOTE NO.
202111260007

DOOR STYLE
Shaker

FINISH
Weathered Graphite

DRAWN BY
LL

ISSUE

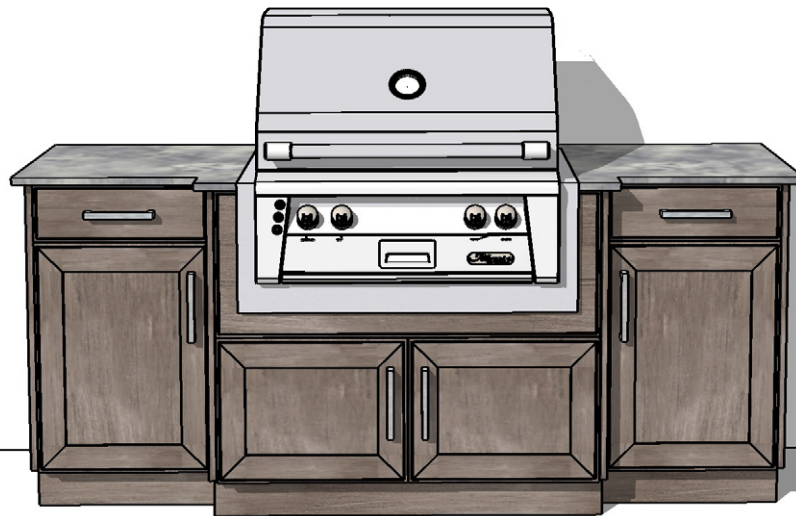

● Metro Lite

◆ Shaker Weathered Graphite (shown)

● Contempo SS Weathered Graphite

\$7,893

●
\$6,033

●
\$9,972

DESCRIPTION
Perspective

Note: this is not a quote. Prices shown are for reference only and reflect the MSRP of a few select options.

A0.1



NatureKast Weatherproof Cabinetry
570 Welland Ave, Unit 5
St. Catharines, ON L2M 5V6
Tel: 1.844.880.6314

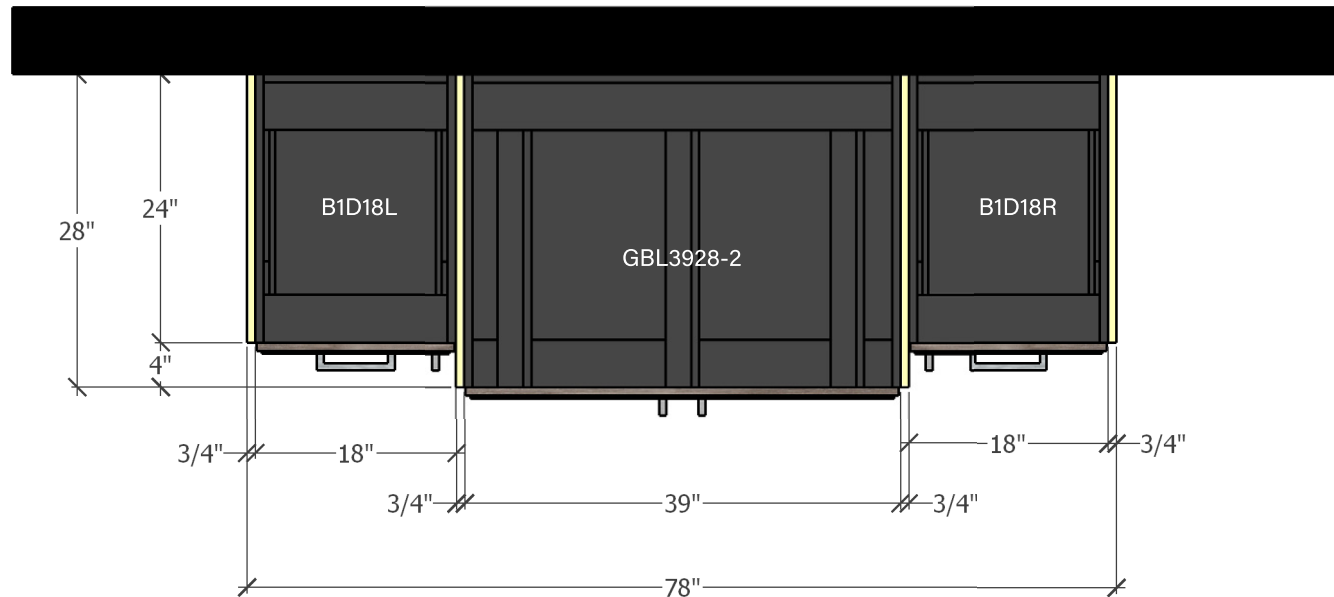

Finishing Components:

- (1) BFEA2430L (applied to B1D18L)
- (1) BFEA2430R (applied to B1D18R)
- (1) BFEA2830L (applied to GBL3928-2)
- (1) BFEA2830R (applied to GBL3928-2)
- (2) NK596

DEALER

PROJECT

QUOTE NO.
202111260007

DOOR STYLE
Shaker

FINISH
Weathered Graphite

DRAWN BY
LL

ISSUE

DESCRIPTION
Floor Plan

A0.2

B. 6' Ceramic Grill Run



NatureKast Weatherproof Cabinetry
570 Welland Ave, Unit 5
St. Catharines, ON L2M 5V6
Tel: 1.844.880.6314

DEALER

PROJECT

QUOTE NO.
202111260006

DOOR STYLE
Shaker

FINISH
Weathered Graphite

DRAWN BY
LL

ISSUE



● Metro Lite

◆ Shaker Weathered Graphite (shown)

● Contempo SS Weathered Graphite

\$9,508

●
\$7,203

●
\$12,164

DESCRIPTION
Perspective

Note: this is not a quote. Prices shown are for reference only and reflect the MSRP of a few select options.

B0.1



NatureKast Weatherproof Cabinetry
570 Welland Ave, Unit 5
St. Catharines, ON L2M 5V6
Tel: 1.844.880.6314

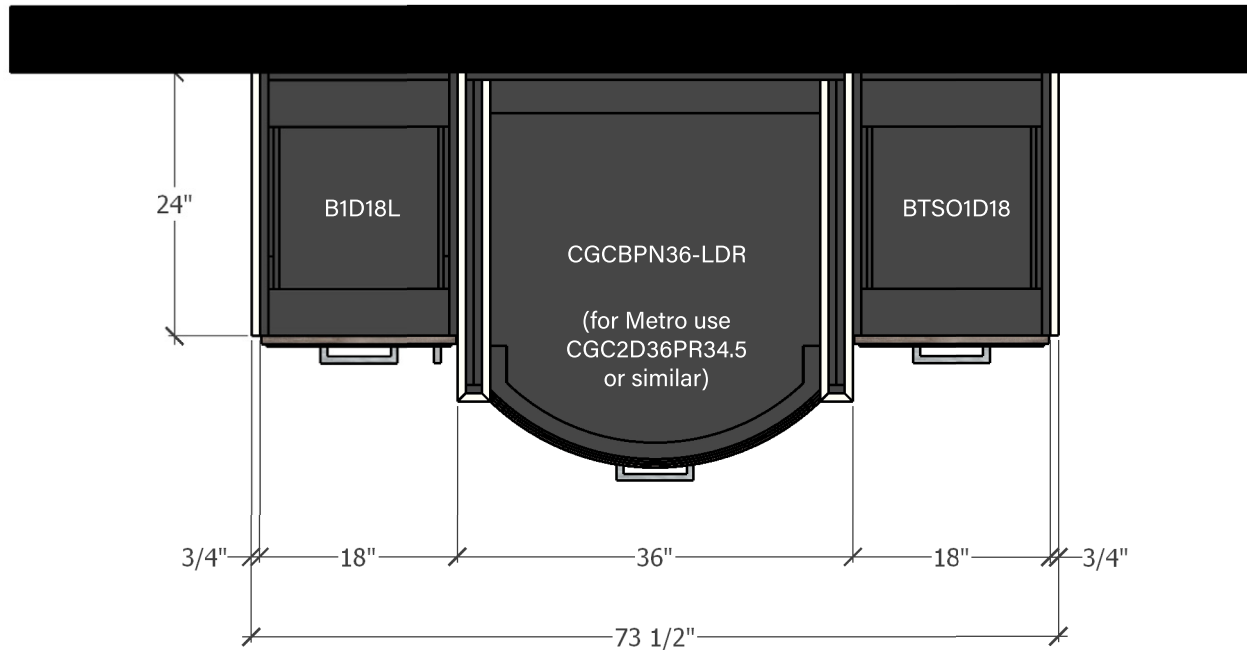

DEALER

PROJECT

QUOTE NO.
202111260006

DOOR STYLE
Shaker
FINISH
Weathered Graphite

DRAWN BY
LL

ISSUE

Finishing Components:

- (1) BFEA2430L (applied to B1D18L)
- (1) BFEA2430R (applied to BTSO1D18)
- (1) NK596

DESCRIPTION
Floor Plan

B0.2

C. 7' Grill Run



NatureKast Weatherproof Cabinetry
570 Welland Ave, Unit 5
St. Catharines, ON L2M 5V6
Tel: 1.844.880.6314

DEALER

PROJECT

QUOTE NO.
202111260008

DOOR STYLE
Shaker

FINISH
Weathered Graphite

DRAWN BY
LL

ISSUE

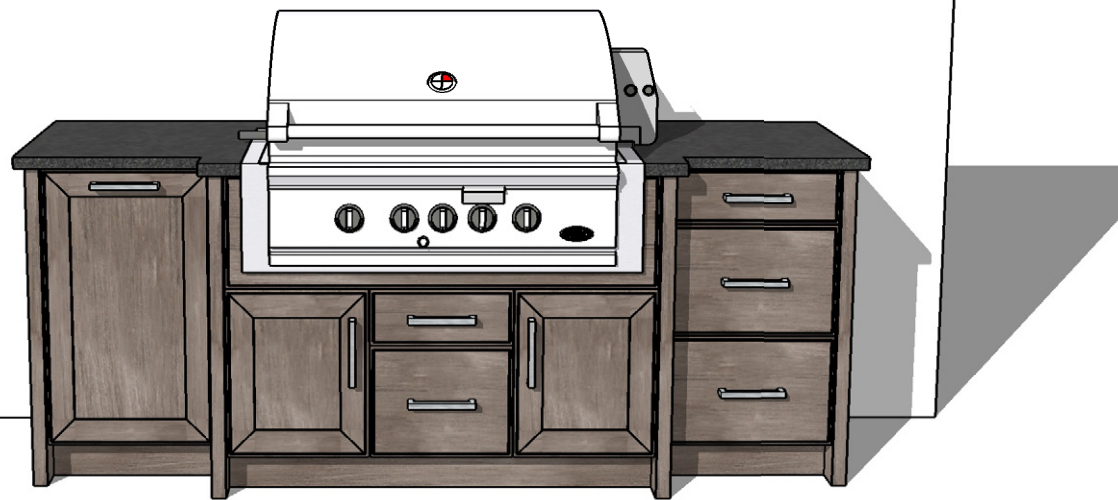

● Metro Lite

◆ Shaker Weathered Graphite

● Contempo SS Weathered Graphite

●
\$7,815

\$11,679



●
\$14,372

DESCRIPTION
Perspective

Note: this is not a quote. Prices shown are for reference only and reflect the MSRP of a few select options.

C0.1



NatureKast Weatherproof Cabinetry
570 Welland Ave, Unit 5
St. Catharines, ON L2M 5V6
Tel: 1.844.880.6314

DEALER

PROJECT

QUOTE NO.
202111260008

DOOR STYLE
Shaker

FINISH
Weathered Graphite

DRAWN BY
LL

ISSUE

DESCRIPTION
Floor Plan

C0.2

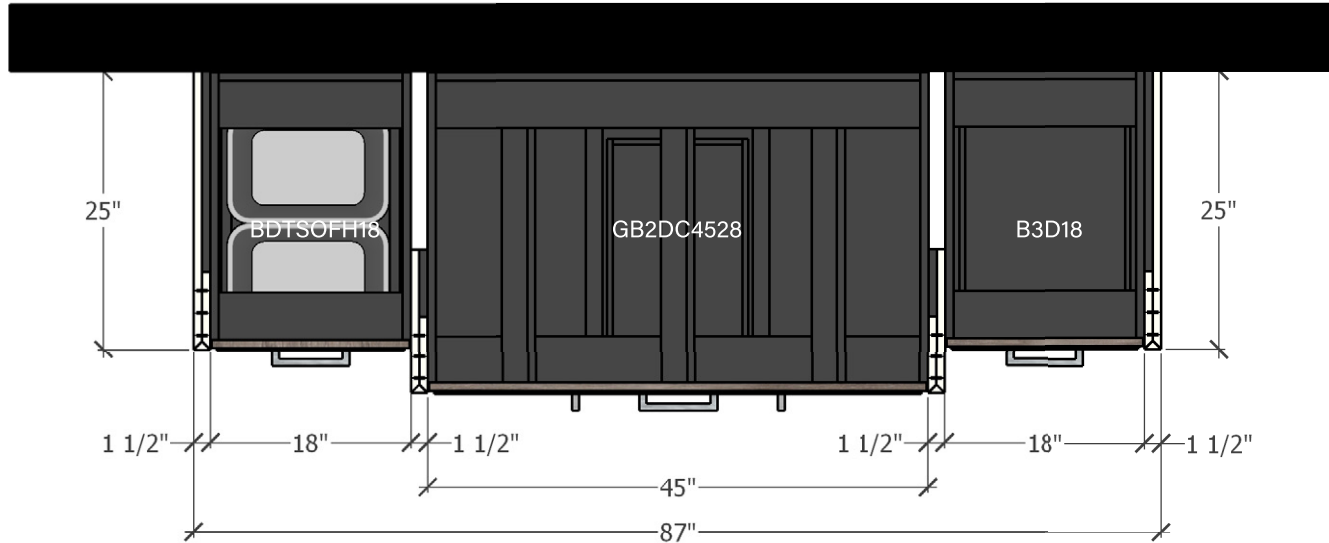

Finishing Components:

- (2) BPB-R1.536-25 (for Metro use [2] BASE HDPE 24 7/8W 36H or BPB 336-25 pilasters)
- (2) BPB-R1.536-13 (for Metro use [2] BASE HDPE 13W 36H or BPA336-7 pilasters)
- (1) NK596

D. 7' Grill Run with Uppers



NatureKast Weatherproof Cabinetry
 570 Welland Ave, Unit 5
 St. Catharines, ON L2M 5V6
 Tel: 1.844.880.6314



DEALER

PROJECT

QUOTE NO.
 202203070027

DOOR STYLE
 Shaker

FINISH
 Weathered Graphite

DRAWN BY
 LL

ISSUE

● Metro Lite

◆ Shaker Weathered Graphite (shown)

● Contempo SS Weathered Graphite



DESCRIPTION
 Perspective

Note: this is not a quote. Prices shown are for reference only and reflect the MSRP of a few select options.

D0.1



NatureKast Weatherproof Cabinetry
570 Welland Ave, Unit 5
St. Catharines, ON L2M 5V6
Tel: 1.844.880.6314

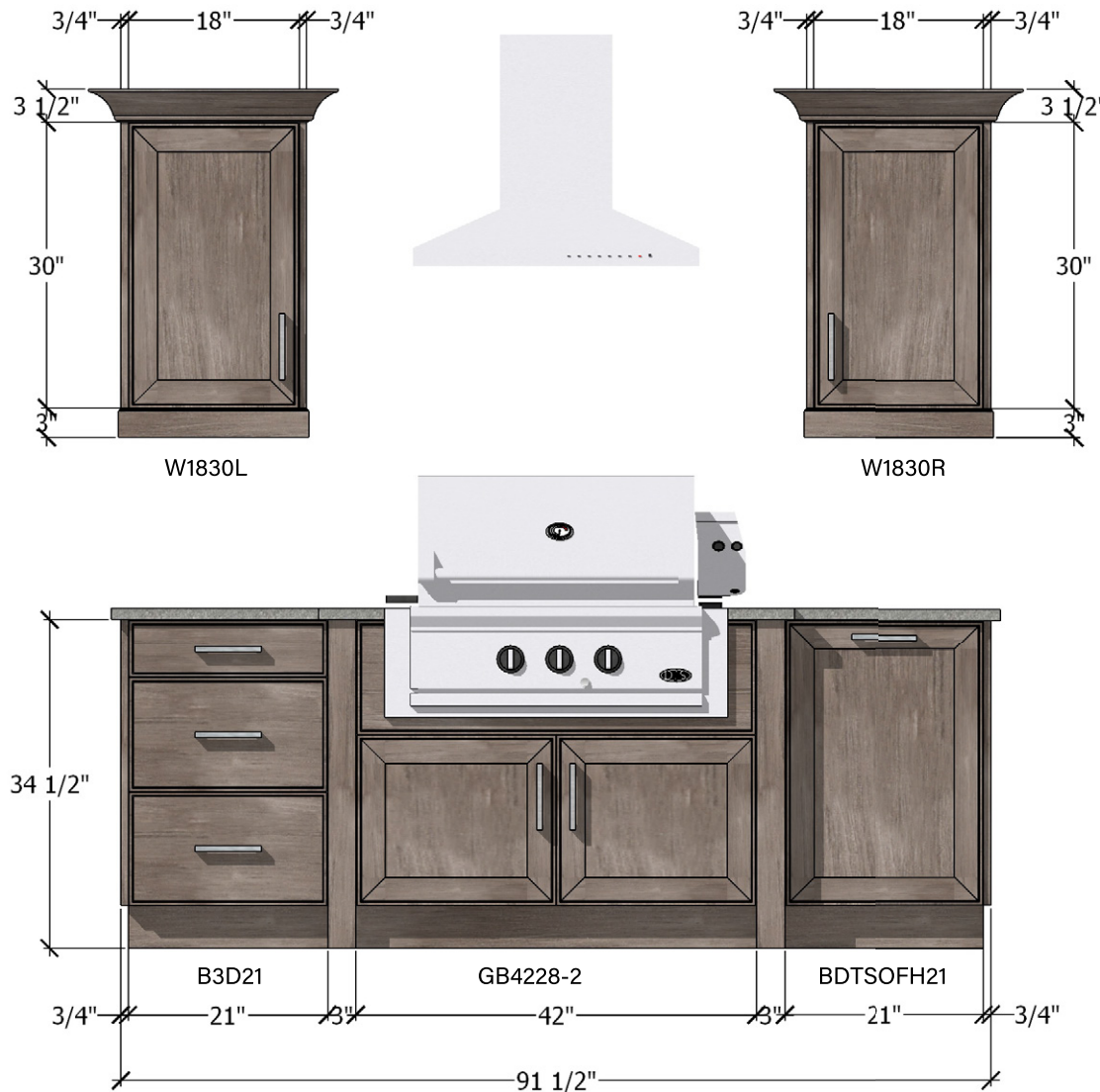

DEALER

PROJECT

QUOTE NO.
202203070027

DOOR STYLE
Shaker
FINISH
Weathered Graphite

DRAWN BY
LL

ISSUE

DESCRIPTION
Floor Plan

Finishing Components:

- (1) BFEA2430L (applied to B3D21)
- (1) BFEA2430R (applied to BDTSOFH21)
- (2) BPB336-13
- (2) NK596

- (1) WFEA1230L (applied to W1830L)
- (1) WFEA1230R (applied to W1830R)
- (1) WFEA1230L (applied to W1830L)
- (1) WFEA1230R (applied to W1830R)
- (1) CRWN96 (for Metro use FB396)
- (1) LR396 (for Metro use FB396)

D0.2

E. 8' Grill & Side Burner Run



NatureKast Weatherproof Cabinetry
570 Welland Ave, Unit 5
St. Catharines, ON L2M 5V6
Tel: 1.844.880.6314

DEALER

PROJECT

QUOTE NO.
202111260011

DOOR STYLE
Shaker

FINISH
Weathered Graphite

DRAWN BY
LL

ISSUE

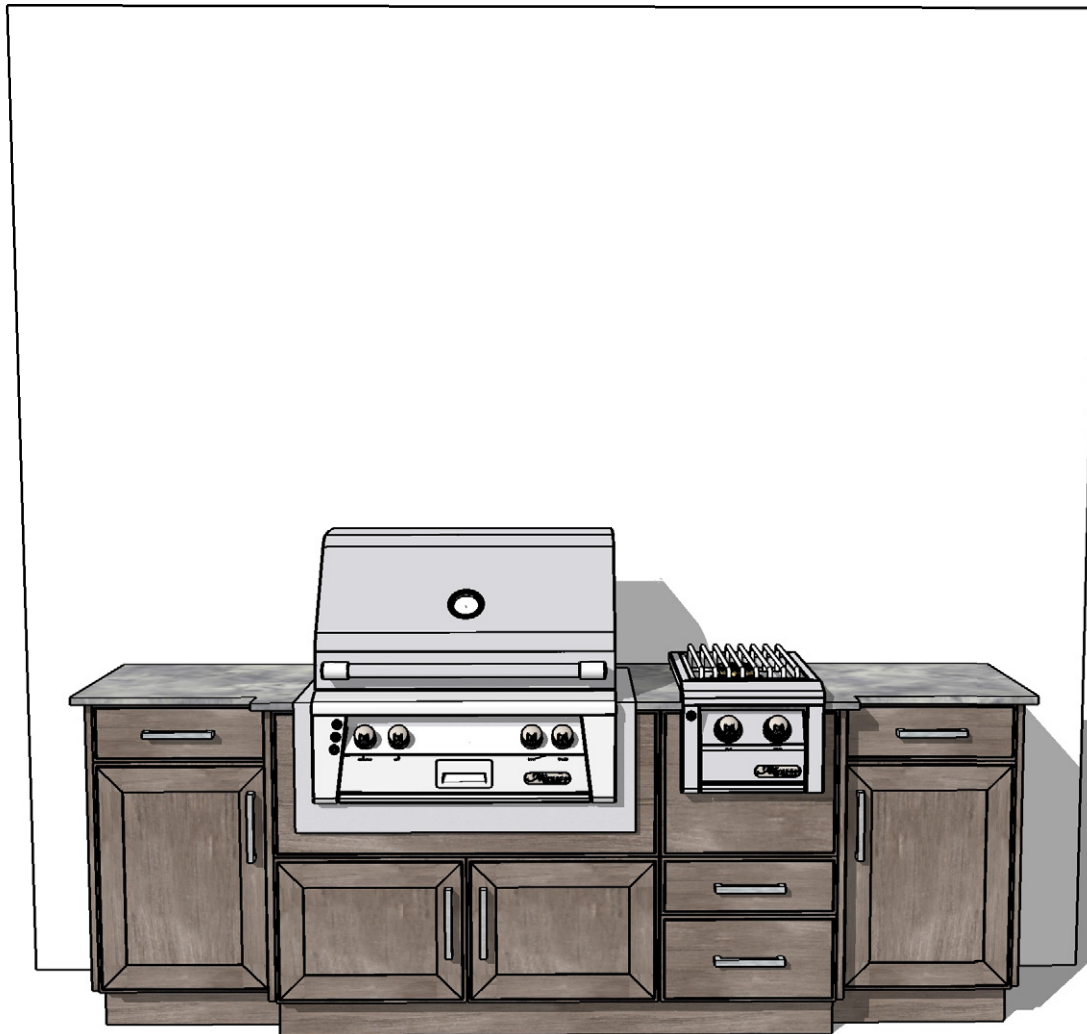

● Metro Lite

◆ Shaker Weathered Graphite (shown)

● Contempo SS Weathered Graphite

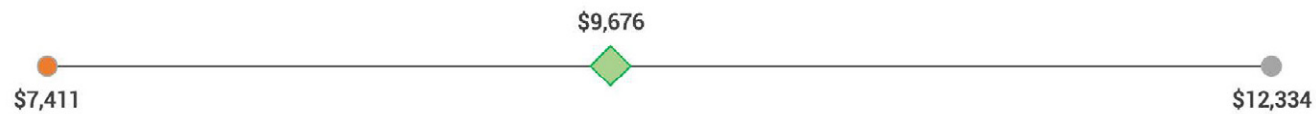

Note: this is not a quote. Prices shown are for reference only and reflect the MSRP of a few select options.

DESCRIPTION
Perspective

E0.1



NatureKast Weatherproof Cabinetry
570 Welland Ave, Unit 5
St. Catharines, ON L2M 5V6
Tel: 1.844.880.6314

DEALER

PROJECT

QUOTE NO.
202111260011

DOOR STYLE
Shaker

FINISH
Weathered Graphite

DRAWN BY
LL

ISSUE

DESCRIPTION
Floor Plan

E0.2



Finishing Components:

- (1) BFEA2430L (applied to B1D18L)
- (1) BFEA2430R (applied to B1D18R)
- (1) BFEA2830L (applied to GBL3928-2)
- (1) BFEA2430R (applied to BBL2D18)
- (2) NK596

F. 8' x 8' L-shaped Sink & Cooktop Island



NatureKast Weatherproof Cabinetry
 570 Welland Ave, Unit 5
 St. Catharines, ON L2M 5V6
 Tel: 1.844.880.6314

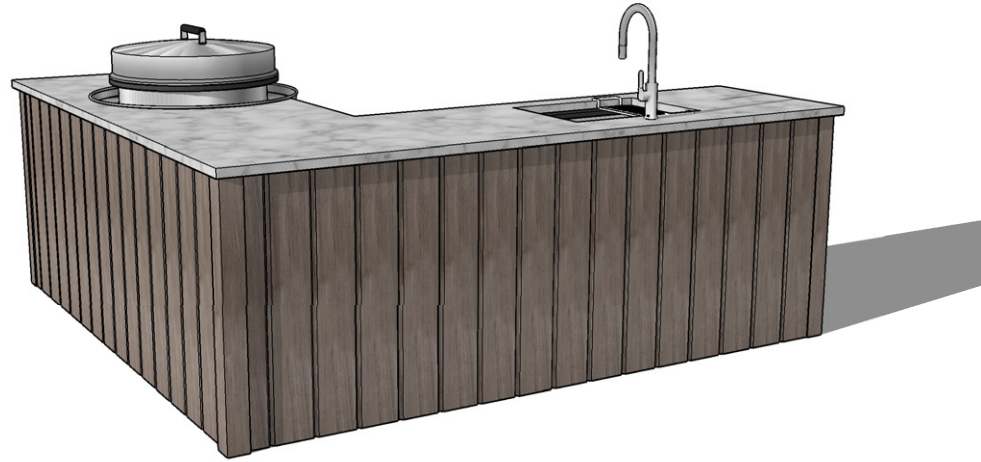

DEALER

PROJECT

QUOTE NO.
 202203070029



DOOR STYLE
 Shaker

FINISH
 Weathered Graphite

DRAWN BY
 LL

ISSUE

● Metro Lite

◆ Shaker Weathered Graphite (shown)

● Contempo SS Weathered Graphite



DESCRIPTION
 Perspective

Note: this is not a quote. Prices shown are for reference only and reflect the MSRP of a few select options.

F0.1



NatureKast Weatherproof Cabinetry
570 Welland Ave, Unit 5
St. Catharines, ON L2M 5V6
Tel: 1.844.880.6314

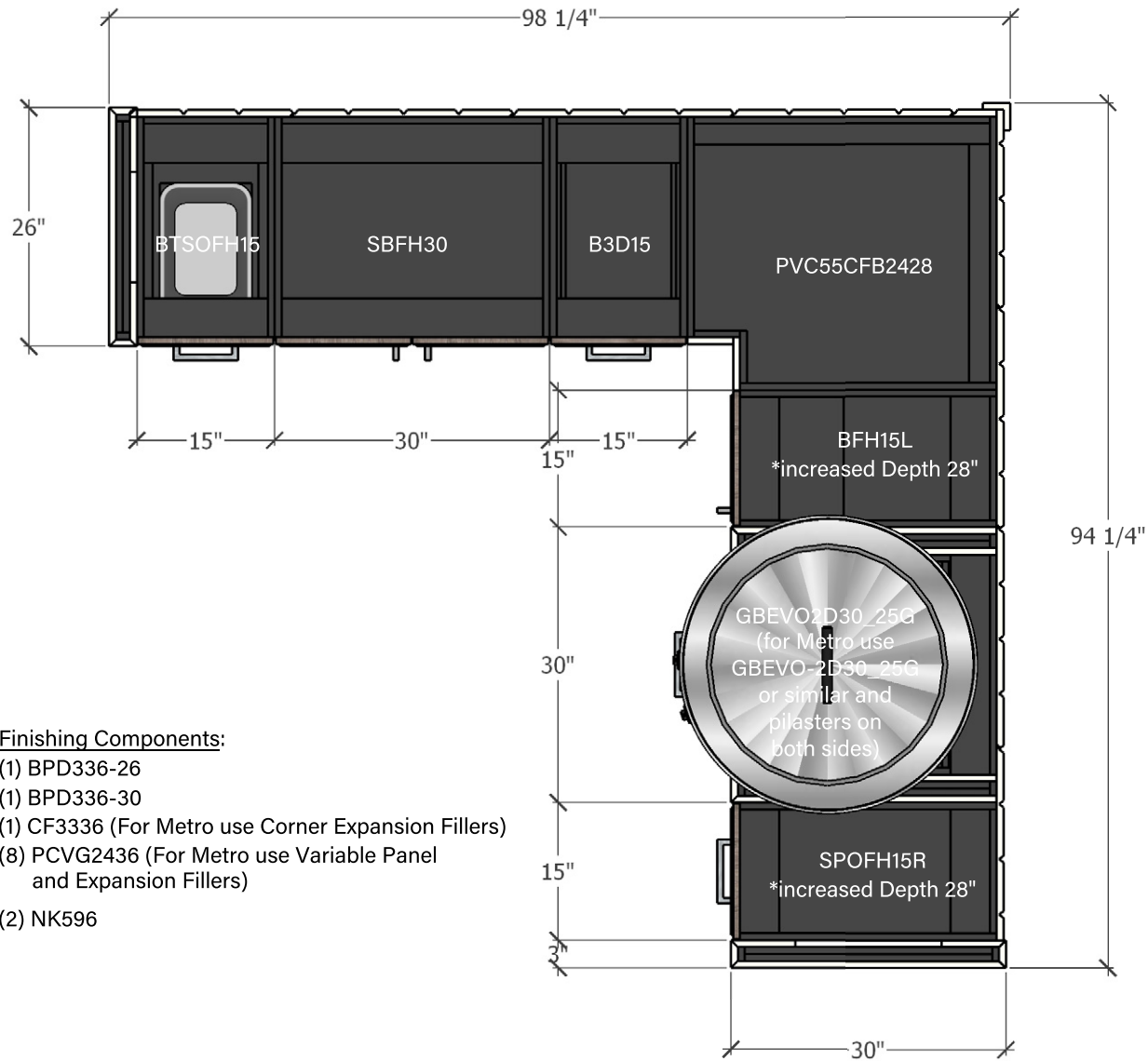

Finishing Components:

- (1) BPD336-26
- (1) BPD336-30
- (1) CF3336 (For Metro use Corner Expansion Fillers)
- (8) PCVG2436 (For Metro use Variable Panel and Expansion Fillers)
- (2) NK596

DEALER

PROJECT

QUOTE NO.
202203070029

DOOR STYLE
Shaker

FINISH
Weathered Graphite

DRAWN BY
LL

ISSUE

DESCRIPTION
Floor Plan

F0.2

G. 9' x 8' L-shaped Sink & Grill Run



NatureKast Weatherproof Cabinetry
 570 Welland Ave, Unit 5
 St. Catharines, ON L2M 5V6
 Tel: 1.844.880.6314

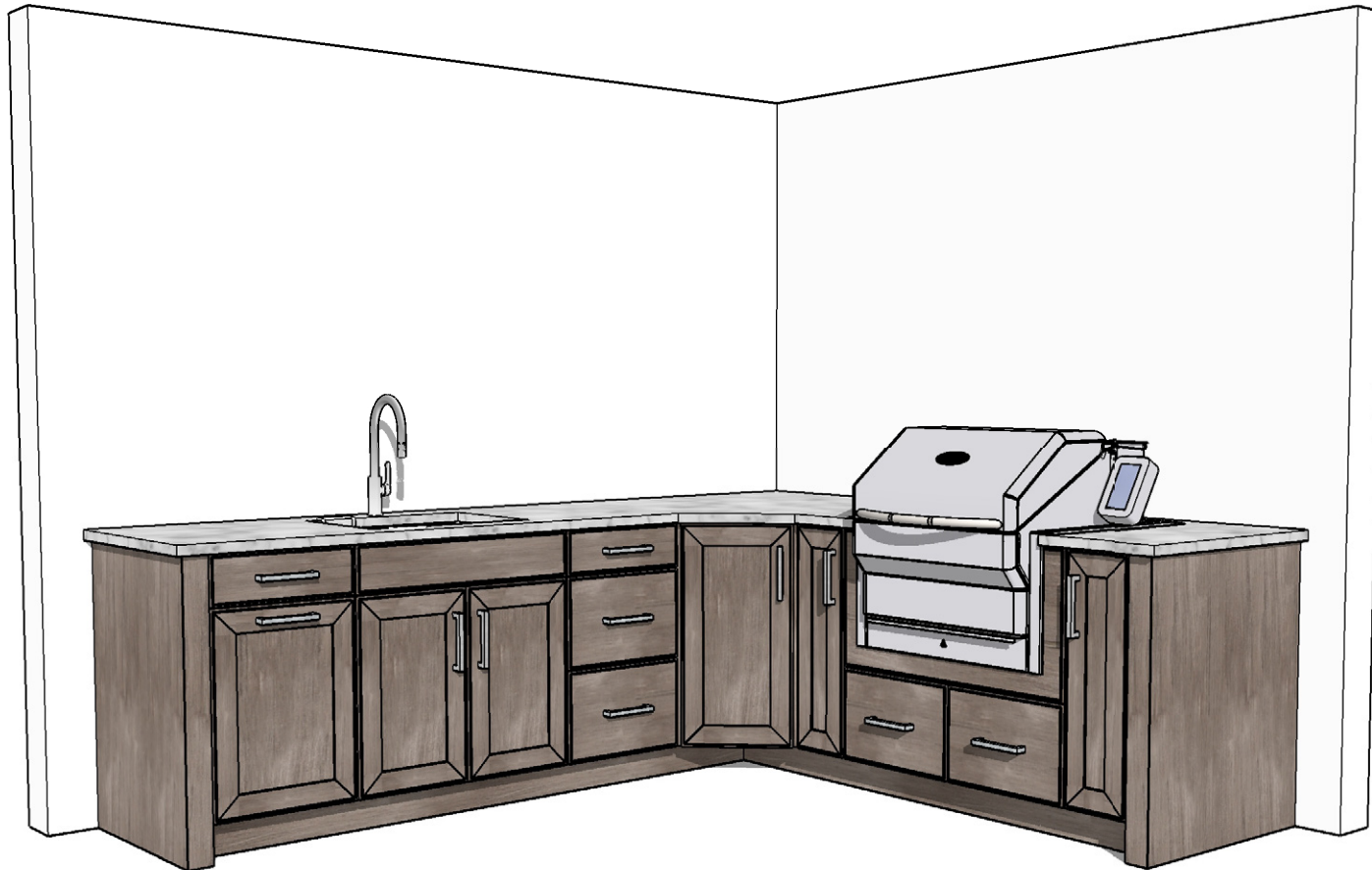

DEALER

PROJECT

QUOTE NO.
 202203070030

DOOR STYLE
 Shaker

FINISH
 Weathered Graphite

DRAWN BY
 LL

ISSUE

- Metro Lite
- ◆ Shaker Weathered Graphite (shown)
- Contempo SS Weathered Graphite

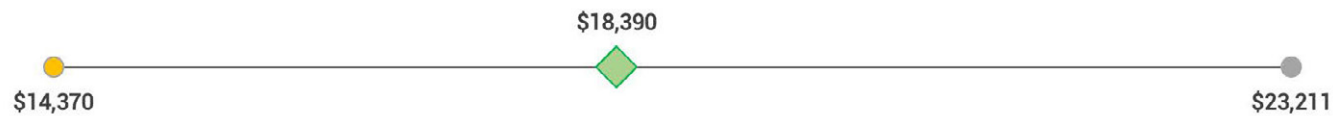

Note: this is not a quote. Prices shown are for reference only and reflect the MSRP of a few select options.

DESCRIPTION
 Perspective

G0.1



NatureKast Weatherproof Cabinetry
570 Welland Ave, Unit 5
St. Catharines, ON L2M 5V6
Tel: 1.844.880.6314

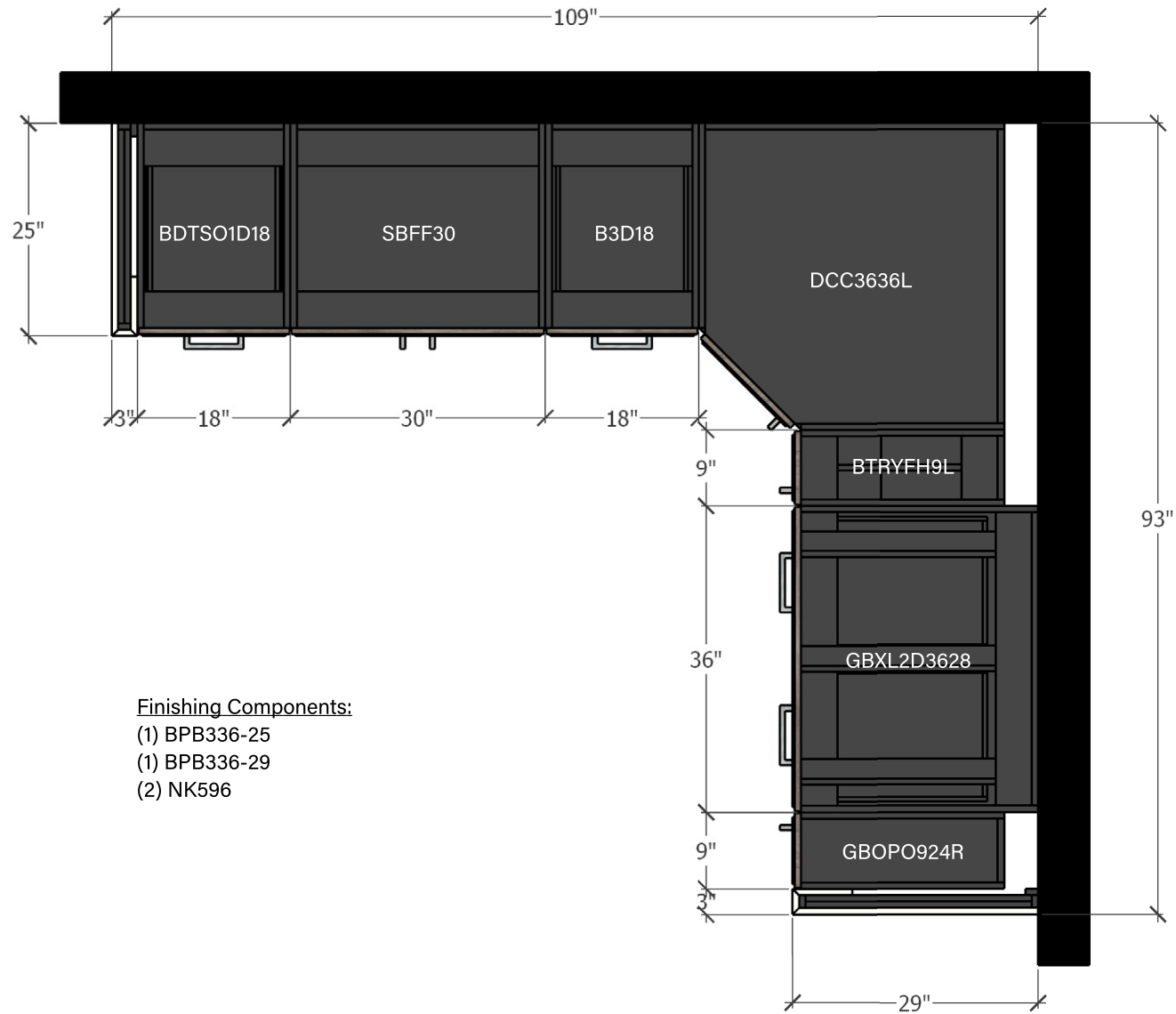

Finishing Components:

- (1) BPB336-25
- (1) BPB336-29
- (2) NK596

DEALER

PROJECT

QUOTE NO.
202203070030

DOOR STYLE
Shaker

FINISH
Weathered Graphite

DRAWN BY
LL

ISSUE

DESCRIPTION
Floor Plan

G0.2

H. 10' Galley Sink Island



NatureKast Weatherproof Cabinetry
 570 Welland Ave, Unit 5
 St. Catharines, ON L2M 5V6
 Tel: 1.844.880.6314



DEALER

PROJECT

QUOTE NO.
 202112160028

DOOR STYLE
 Shaker

FINISH
 Weathered Graphite

DRAWN BY
 LL

ISSUE

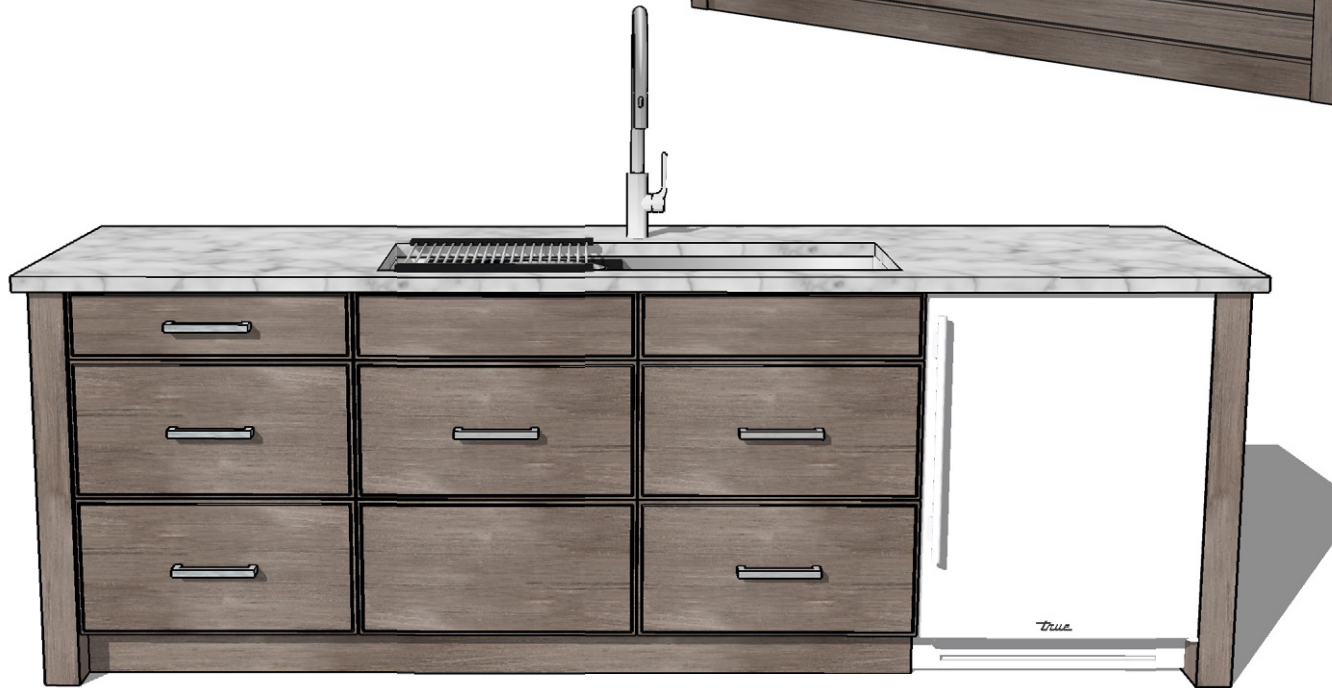

● Metro Lite

◆ Shaker Weathered Graphite (shown)

● Contempo SS Weathered Graphite



DESCRIPTION
 Perspective

Note: this is not a quote. Prices shown are for reference only and reflect the MSRP of a few select options.

H0.1



NatureKast Weatherproof Cabinetry
570 Welland Ave, Unit 5
St. Catharines, ON L2M 5V6
Tel: 1.844.880.6314

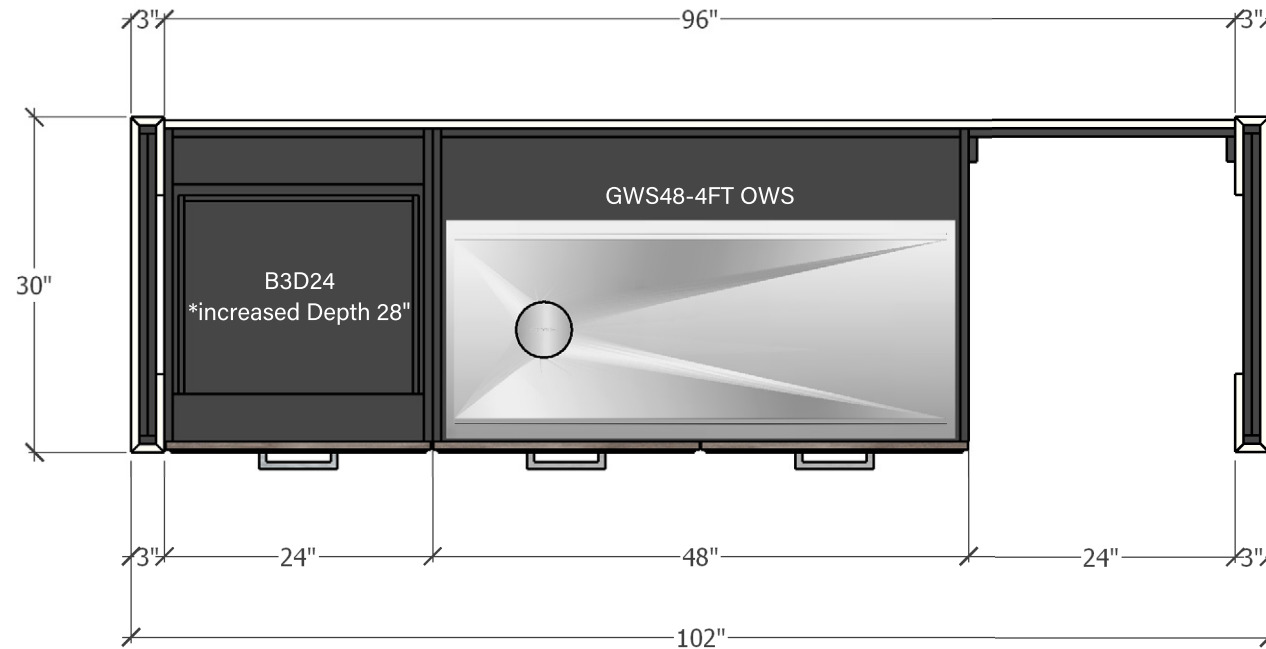

Finishing Components:

- (2) BPD336-30
- (1) PVCAPPLSP2436
- (6) CP696 (For Metro use Variable Panel and Expansion Fillers)
- (1) NK596

DEALER

PROJECT

QUOTE NO.
202112160028

DOOR STYLE
Shaker

FINISH
Weathered Graphite

DRAWN BY
LL

ISSUE

DESCRIPTION
Floor Plan

H0.2

I. 10' Cooktop & Sink Run



NatureKast Weatherproof Cabinetry
570 Welland Ave, Unit 5
St. Catharines, ON L2M 5V6
Tel: 1.844.880.6314

DEALER

PROJECT

QUOTE NO.
202111260012

DOOR STYLE
Shaker

FINISH
Weathered Graphite

DRAWN BY
LL

ISSUE



● Metro Lite

◆ Shaker Weathered Graphite (shown)

● Contempo SS Weathered Graphite

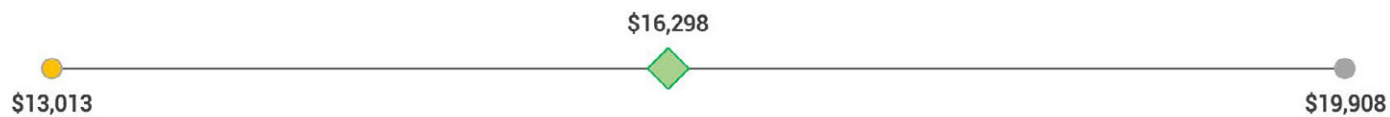

Note: this is not a quote. Prices shown are for reference only and reflect the MSRP of a few select options.

DESCRIPTION
Perspective

10.1



NatureKast Weatherproof Cabinetry
570 Welland Ave, Unit 5
St. Catharines, ON L2M 5V6
Tel: 1.844.880.6314

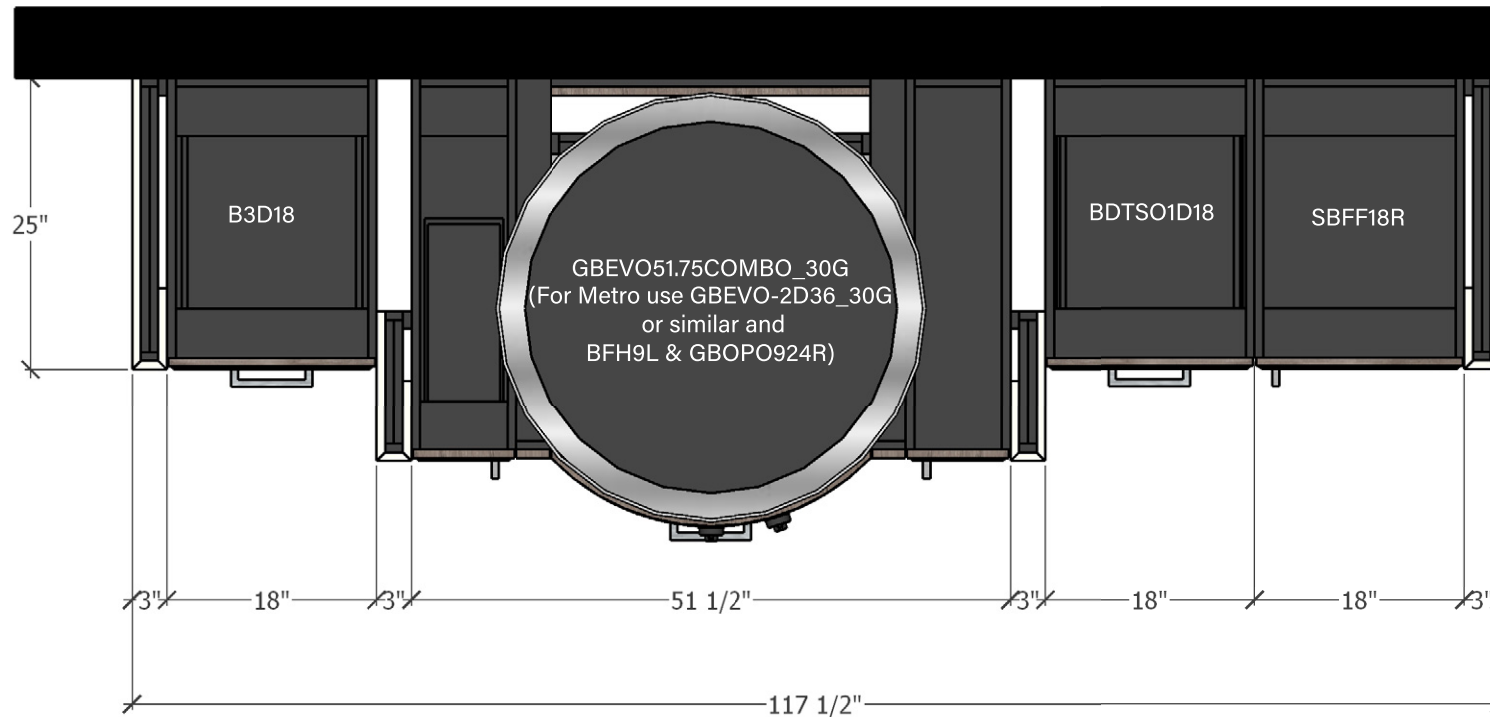

DEALER

PROJECT

QUOTE NO.
202111260012

DOOR STYLE
Shaker

FINISH
Weathered Graphite

DRAWN BY
LL

ISSUE

Finishing Components:

- (2) BPB336-25
- (2) BPB336-13
- (2) NK596

DESCRIPTION
Floor Plan

10.2

J. 10' Grill & Cooktop Run



NatureKast Weatherproof Cabinetry
570 Welland Ave, Unit 5
St. Catharines, ON L2M 5V6
Tel: 1.844.880.6314



DEALER

PROJECT

QUOTE NO.
202111260013

DOOR STYLE
Shaker

FINISH
Weathered Graphite

DRAWN BY
LL

ISSUE

● Metro Lite

◆ Shaker Weathered Graphite (shown)

● Contempo SS Weathered Graphite

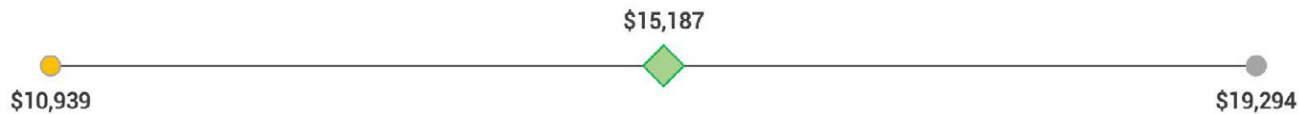

Note: this is not a quote. Prices shown are for reference only and reflect the MSRP of a few select options.

DESCRIPTION
Perspective

J0.1



NatureKast Weatherproof Cabinetry
570 Welland Ave, Unit 5
St. Catharines, ON L2M 5V6
Tel: 1.844.880.6314

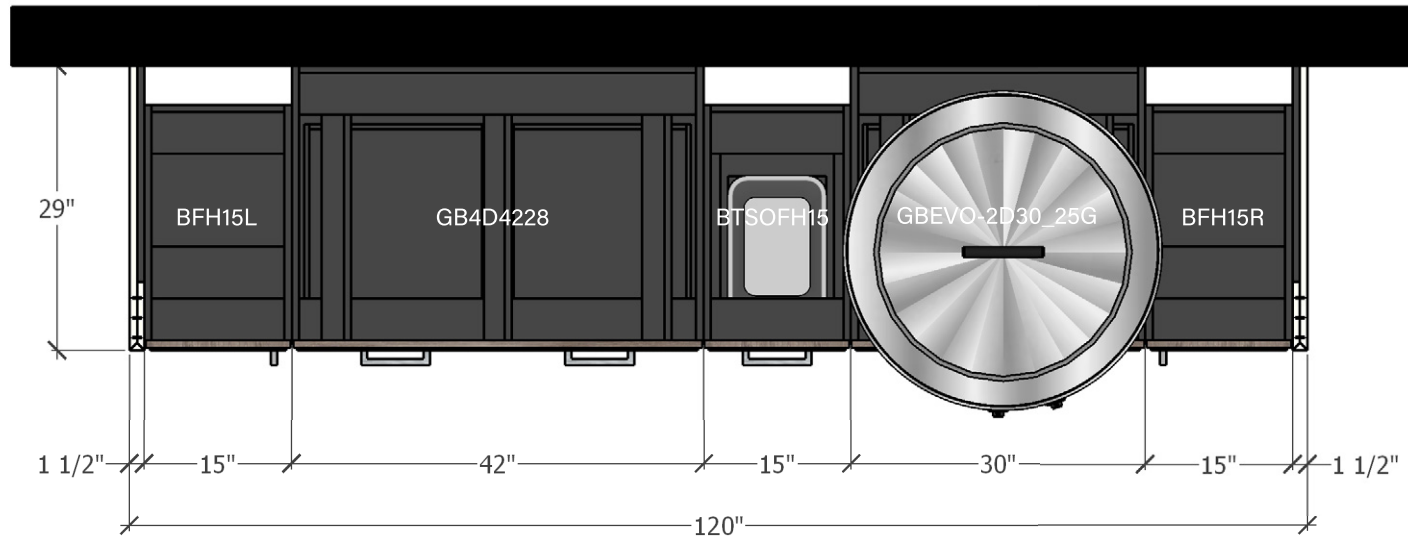

Finishing Components:
(2) BPB-R1.5336-29 (For Metro use Variable Panels)
(2) NK596

DEALER

PROJECT

QUOTE NO.
202111260013

DOOR STYLE
Shaker

FINISH
Weathered Graphite

DRAWN BY
LL

ISSUE

DESCRIPTION
Floor Plan

J0.2

K. 10' Grill & Sink Island



NatureKast Weatherproof Cabinetry
 570 Welland Ave, Unit 5
 St. Catharines, ON L2M 5V6
 Tel: 1.844.880.6314

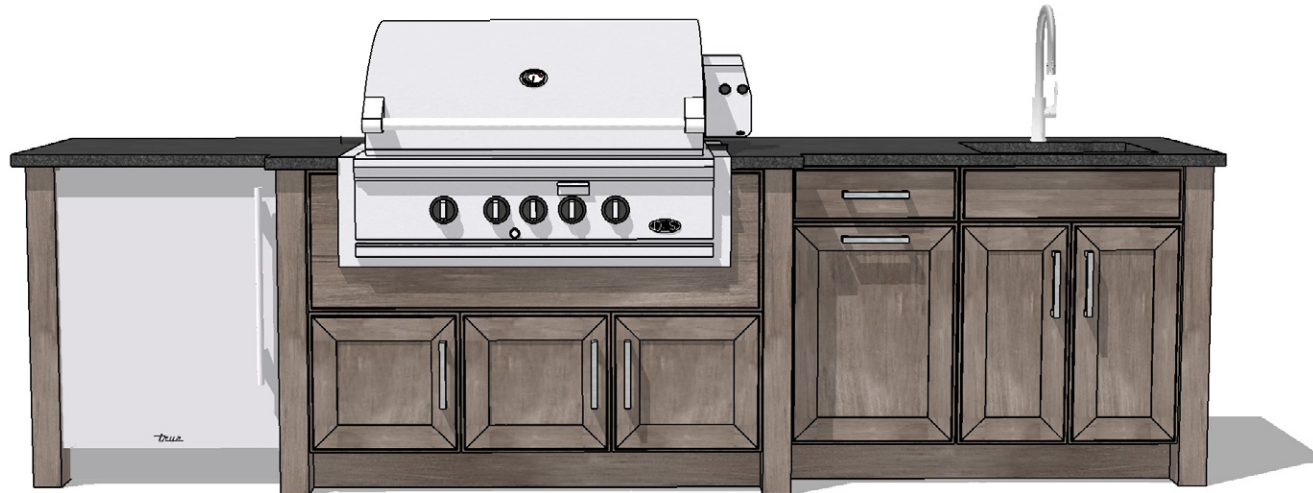
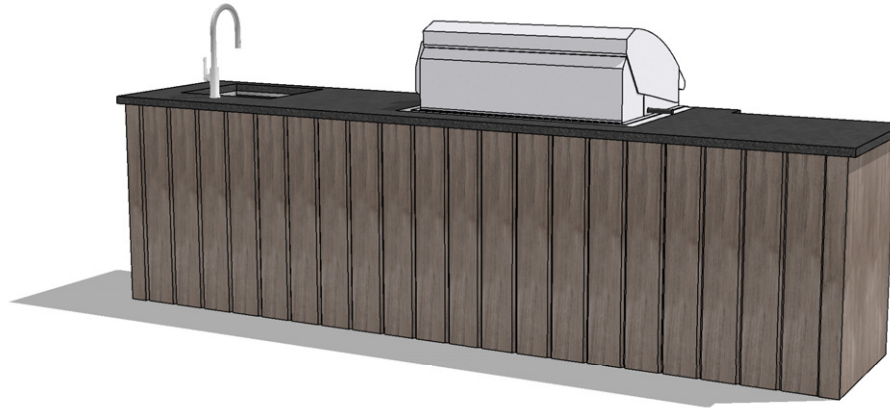

DEALER

PROJECT

QUOTE NO.
 202111260016

DOOR STYLE
 Shaker

FINISH
 Weathered Graphite

DRAWN BY
 LL

ISSUE

● Metro Lite

◆ Shaker Weathered Graphite (shown)

● Contempo SS Weathered Graphite



Note: this is not a quote. Prices shown are for reference only and reflect the MSRP of a few select options.

DESCRIPTION
 Perspective

K0.1



NatureKast Weatherproof Cabinetry
570 Welland Ave, Unit 5
St. Catharines, ON L2M 5V6
Tel: 1.844.880.6314

DEALER

PROJECT

QUOTE NO.
202111260016

DOOR STYLE
Shaker

FINISH
Weathered Graphite

DRAWN BY
LL

ISSUE

DESCRIPTION
Floor Plan

K0.2

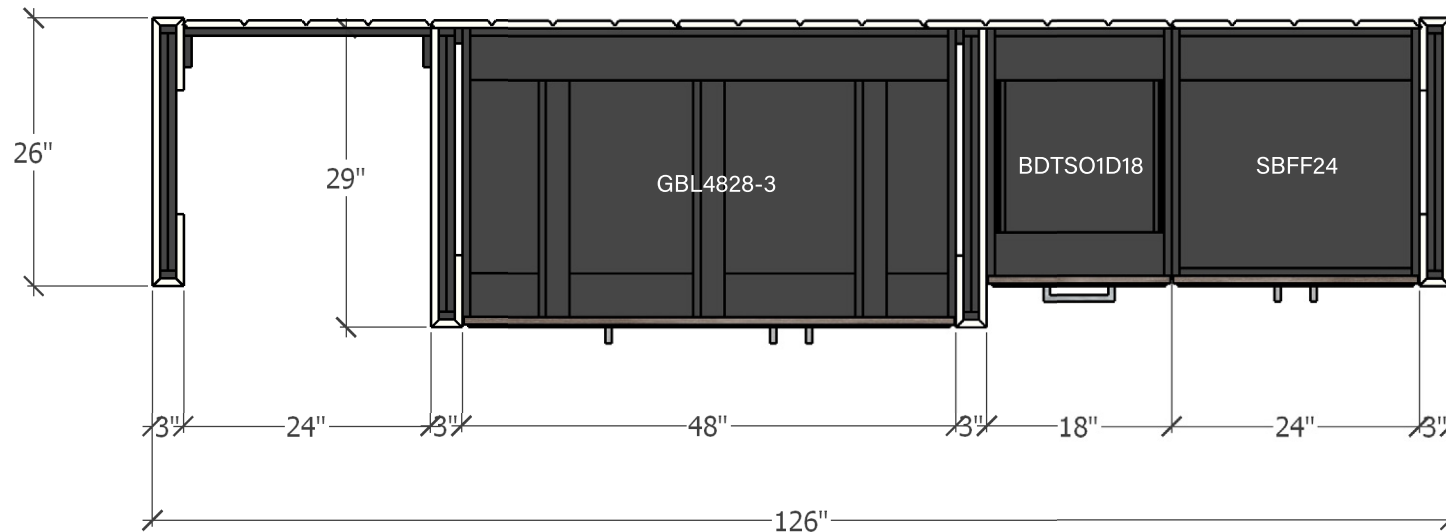

Finishing Components:

- (2) BPD336-26
- (2) BPB336-29
- (1) PVCAPPLSP2436
- (6) PCVG2436 (For Metro use Variable Panel and Metro Expansion Fillers)
- (1) NK596

L. 10' Sink Run



NatureKast Weatherproof Cabinetry
570 Welland Ave, Unit 5
St. Catharines, ON L2M 5V6
Tel: 1.844.880.6314

DEALER

PROJECT

QUOTE NO.
202111260015

DOOR STYLE
Shaker

FINISH
Weathered Graphite

DRAWN BY
LL

ISSUE



● Metro Lite

◆ Shaker Weathered Graphite (shown)

● Contempo SS Weathered Graphite

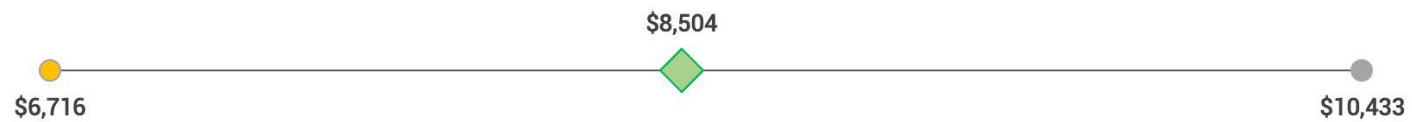

Note: this is not a quote. Prices shown are for reference only and reflect the MSRP of a few select options.

DESCRIPTION
Perspective

L0.1



NatureKast Weatherproof Cabinetry
570 Welland Ave, Unit 5
St. Catharines, ON L2M 5V6
Tel: 1.844.880.6314

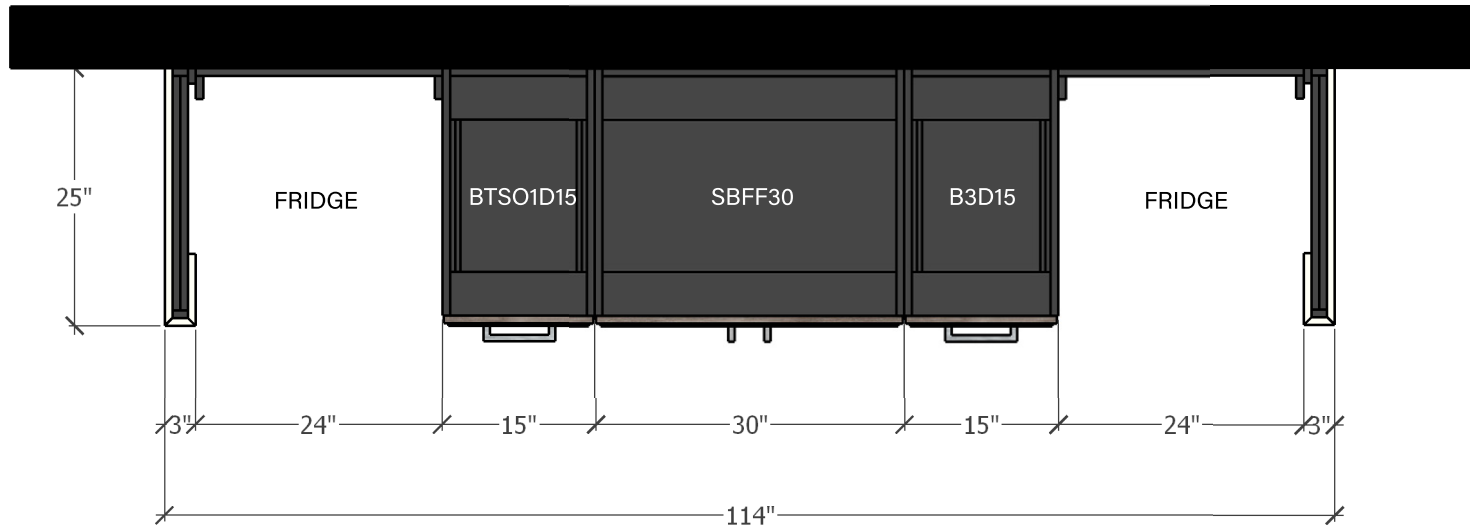

Finishing Components:

- (2) BPB336-25
- (2) PVCAPPLSP2436
- (1) NK596

DEALER

PROJECT

QUOTE NO.
202111260015

DOOR STYLE
Shaker

FINISH
Weathered Graphite

DRAWN BY
LL

ISSUE

DESCRIPTION
Floor Plan

L0.2

M. 10' x 9' Grill & Sink Run with Raised Bar



NatureKast Weatherproof Cabinetry
 570 Welland Ave, Unit 5
 St. Catharines, ON L2M 5V6
 Tel: 1.844.880.6314



DEALER

PROJECT

QUOTE NO.
 202203080007

DOOR STYLE
 Shaker

FINISH
 Weathered Graphite

DRAWN BY
 LL

ISSUE

● Shaker Weathered Graphite (shown)

◆ Shaker Weathered Graphite (shown)

● Contempo SS Weathered Graphite

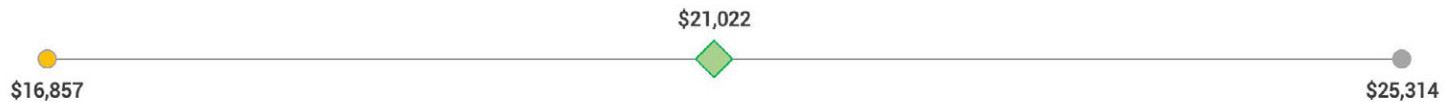

DESCRIPTION
 Perspective

Note: this is not a quote. Prices shown are for reference only and reflect the MSRP of a few select options.

M0.1



NatureKast Weatherproof Cabinetry
570 Welland Ave, Unit 5
St. Catharines, ON L2M 5V6
Tel: 1.844.880.6314

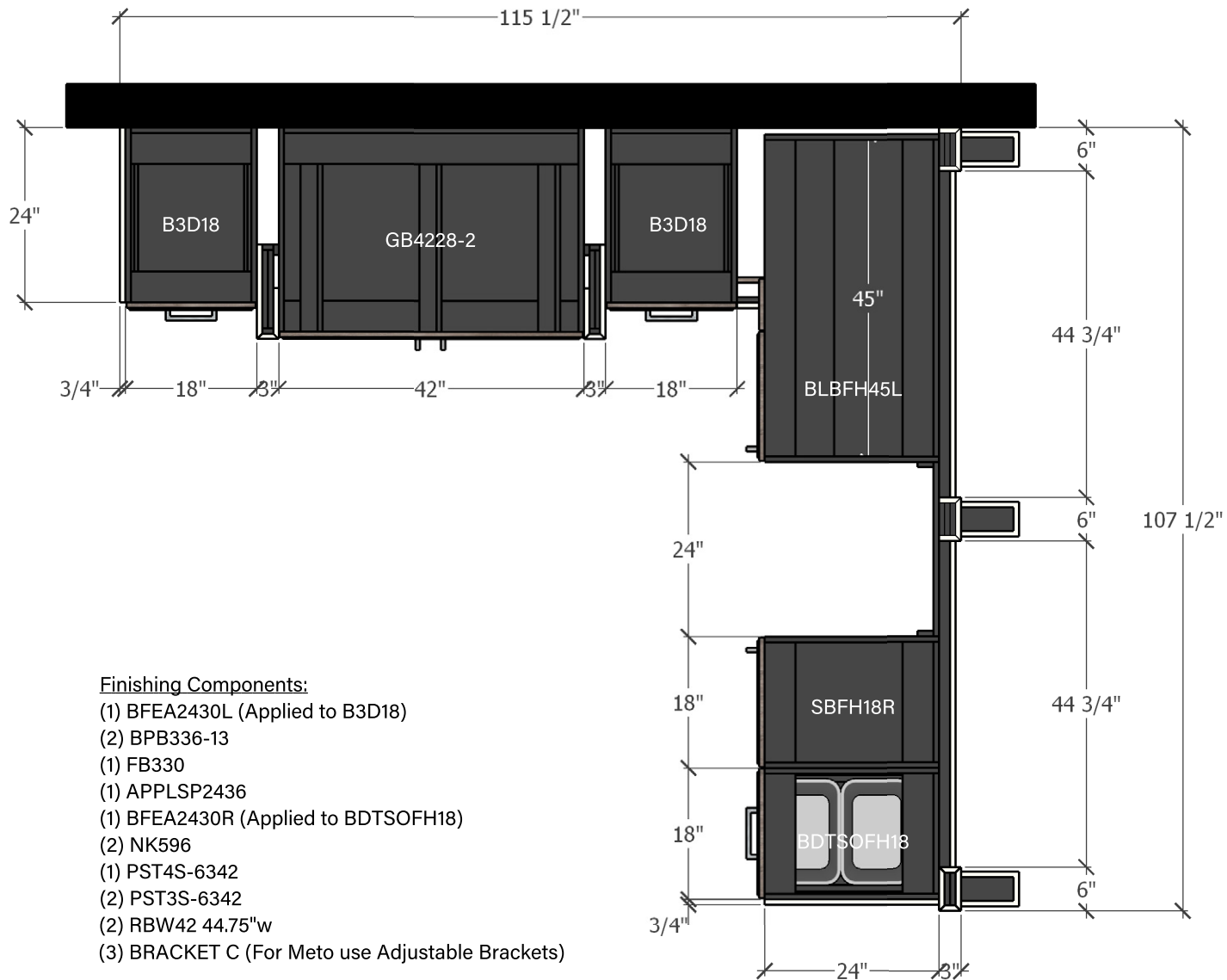

Finishing Components:

- (1) BFEA2430L (Applied to B3D18)
- (2) BPB336-13
- (1) FB330
- (1) APPLSP2436
- (1) BFEA2430R (Applied to BDTSOFH18)
- (2) NK596
- (1) PST4S-6342
- (2) PST3S-6342
- (2) RBW42 44.75"w
- (3) BRACKET C (For Meto use Adjustable Brackets)

DEALER

PROJECT

QUOTE NO.
202203080007

DOOR STYLE
Shaker

FINISH
Weathered Graphite

DRAWN BY
LL

ISSUE

DESCRIPTION
Floor Plan

M0.2

N. 12' Grill & Ceramic Grill Island



NatureKast Weatherproof Cabinetry
570 Welland Ave, Unit 5
St. Catharines, ON L2M 5V6
Tel: 1.844.880.6314



DEALER

PROJECT

QUOTE NO.
202111260020



DOOR STYLE
Shaker

FINISH
Weathered Graphite

DRAWN BY
LL

ISSUE

● Metro Lite

◆ Shaker Weathered Graphite (shown)

● Contempo SS Weathered Graphite



DESCRIPTION
Perspective

No.1

Note: this is not a quote. Prices shown are for reference only and reflect the MSRP of a few select options.



NatureKast Weatherproof Cabinetry
570 Welland Ave, Unit 5
St. Catharines, ON L2M 5V6
Tel: 1.844.880.6314

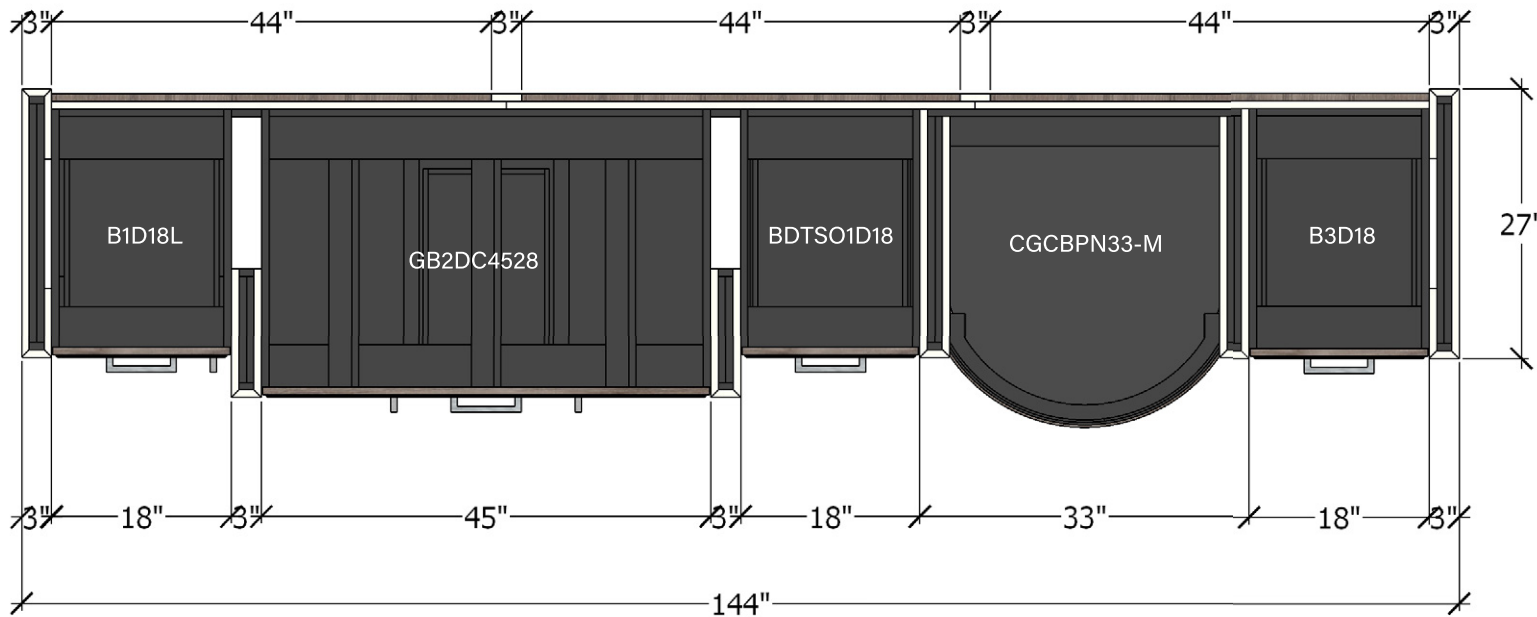

DEALER

PROJECT

QUOTE NO.
202111260020

DOOR STYLE
Shaker
FINISH
Weathered Graphite

DRAWN BY
LL

ISSUE

Finishing Components:

- (2) BPD336-27 (BPD336-25.875-0.75 or Metro)
- (2) BPB336-13
- (2) F336 (Use Metro Expansion fillers [4])
- (3) FP4836 For Metro use Variable Panels)
- (3) FBM696 (Not Available for Metro)
- (2) NK596

DESCRIPTION
Floor Plan

No.2

O. 12' Grill & Sink Run with Hood and Uppers



NatureKast Weatherproof Cabinetry
 570 Welland Ave, Unit 5
 St. Catharines, ON L2M 5V6
 Tel: 1.844.880.6314



Hood Not Available
 in Contempo or Metro
 ** Price below excludes hood**
 Weathered Graphite Shaker hood
 \$5,868.00 (MSRP)

DEALER

PROJECT

QUOTE NO.
 202203080010

DOOR STYLE
 Shaker

FINISH
 Weathered Graphite

DRAWN BY
 LL

ISSUE

● Metro Lite

◆ Shaker Weathered Graphite (shown)

● Contempo SS Weathered Graphite

\$21,613

●
 \$17,222

●
 \$26,698

DESCRIPTION
 Perspective

O.0.1

Note: this is not a quote. Prices shown are for reference only and reflect the MSRP of a few select options.



NatureKast Weatherproof Cabinetry
 570 Welland Ave, Unit 5
 St. Catharines, ON L2M 5V6
 Tel: 1.844.880.6314

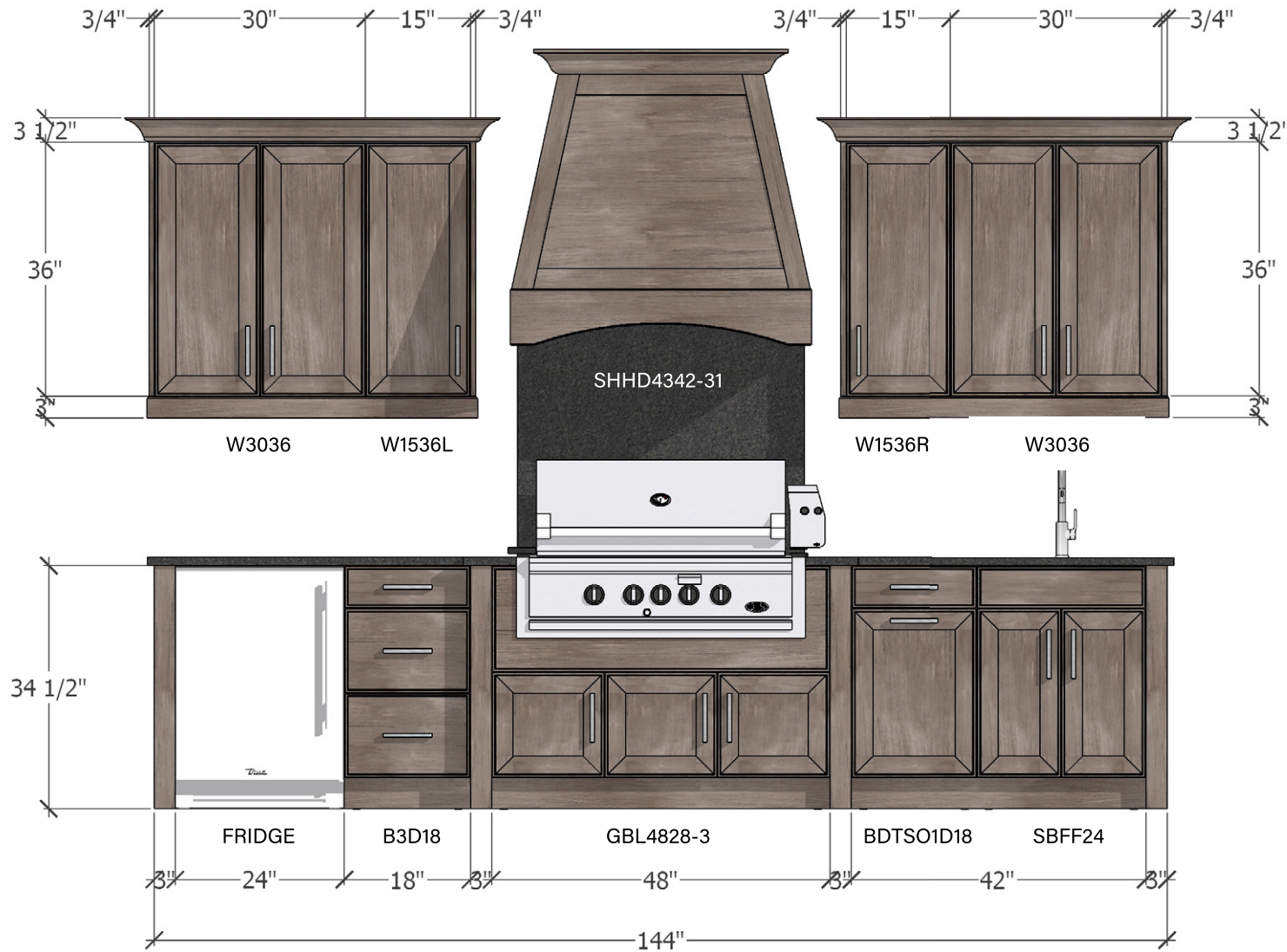

DEALER

PROJECT

QUOTE NO.
 202203080010

DOOR STYLE
 Shaker
 FINISH
 Weathered Graphite

DRAWN BY
 LL
 ISSUE

Finishing Components:

- (2) BPB336-25
- (2) BPB336-13
- (1) PVCAPPLSP2436
- (2) NK596

- (1) WFEA1236L (Applied to Left W3036)
- (1) WFEA1236R (Applied to Left W1536L)
- (1) WFEA1236L (Applied to Right W1536R)
- (1) WFEA1236R (Applied to Right W3036)
- (2) CRWN96 (For Metro use Filler and PVC L-backer)
- (2) LR396 (For Metro use Filler and PVC L-backer)

DESCRIPTION
 Floor Plan

P. 14' Pizza Oven, Grill & Burner Run



NatureKast Weatherproof Cabinetry
 570 Welland Ave, Unit 5
 St. Catharines, ON L2M 5V6
 Tel: 1.844.880.6314

DEALER

PROJECT

QUOTE NO.
 202203080009

DOOR STYLE
 Shaker

FINISH
 Weathered Graphite

DRAWN BY
 LL

ISSUE

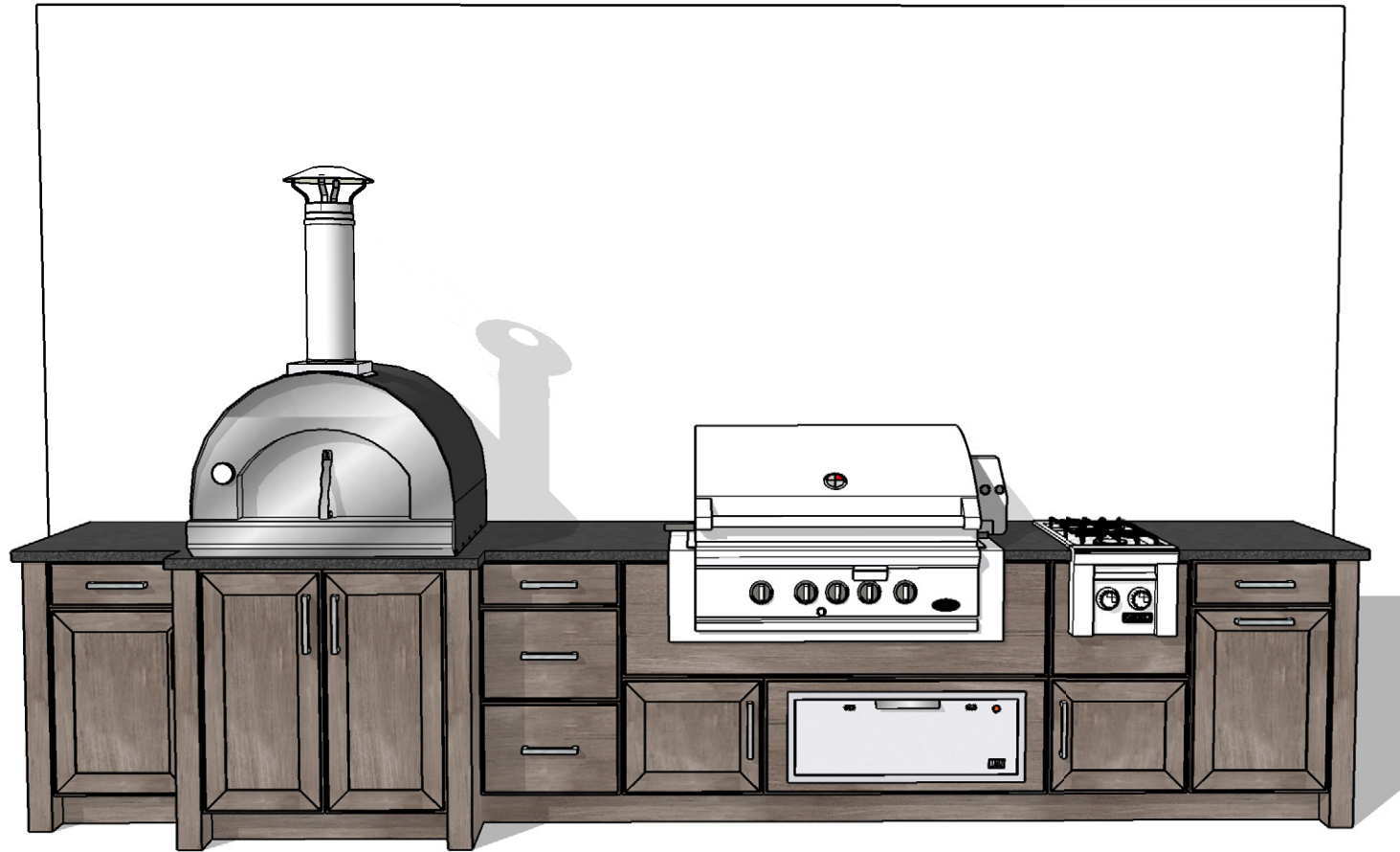

● Metro Lite

◆ Shaker Weathered Graphite (shown)

● Contempo SS Weathered Graphite

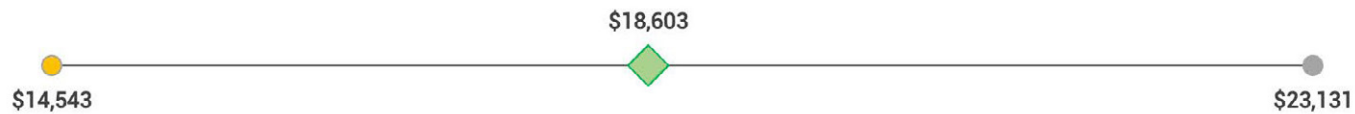

Note: this is not a quote. Prices shown are for reference only and reflect the MSRP of a few select options.

DESCRIPTION
 Perspective

P0.1



NatureKast Weatherproof Cabinetry
570 Welland Ave, Unit 5
St. Catharines, ON L2M 5V6
Tel: 1.844.880.6314

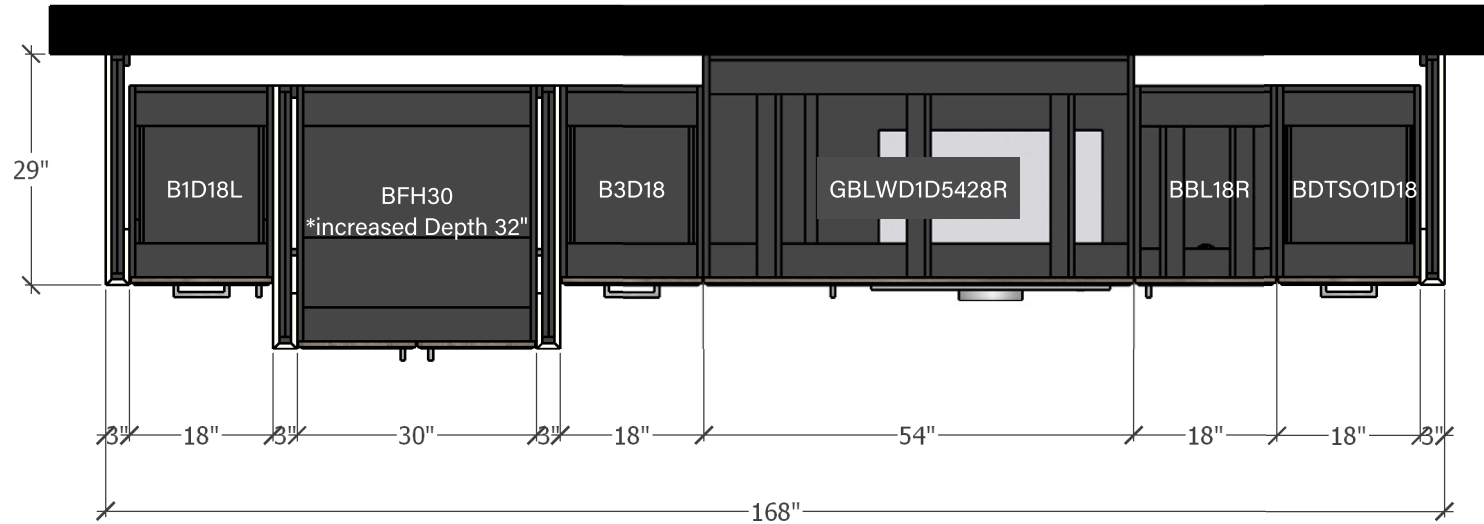

Finishing Components:

- (2) BPB336-29
- (2) BPB336-32
- (2) NK596

DEALER

PROJECT

QUOTE NO.
202203080009

DOOR STYLE
Shaker

FINISH
Weathered Graphite

DRAWN BY
LL

ISSUE

DESCRIPTION
Floor Plan

P0.2